

A Negative Ion Cookbook

<u>1H</u> Hydrogen							<u>2He</u> Helium
<u>3Li</u> Lithium	<u>4Be</u> Beryllium	<u>5B</u> Boron	<u>6C</u> Carbon	<u>7N</u> Nitrogen	<u>8O</u> Oxygen	<u>9F</u> Fluorine	<u>10Ne</u> Neon
<u>11Na</u> Sodium	<u>12Mg</u> Magnesium	<u>13Al</u> Aluminum	<u>14Si</u> Silicon	<u>15P</u> Phosphorus	<u>16S</u> Sulfur	<u>17Cl</u> Chlorine	<u>18Ar</u> Argon
<u>19K</u> Potassium	<u>20Ca</u> Calcium	<u>31Ga</u> Gallium	<u>32Ge</u> Germanium	<u>33As</u> Arsenic	<u>34Se</u> Selenium	<u>35Br</u> Bromine	<u>36Kr</u> Krypton
<u>37Rb</u> Rubidium	<u>38Sr</u> Strontium	<u>49In</u> Indium	<u>50Sn</u> Tin	<u>51Sb</u> Antimony	<u>52Te</u> Tellurium	<u>53I</u> Iodine	<u>54Xe</u> Xenon
<u>55Cs</u> Cesium	<u>56Ba</u> Barium	<u>81Tl</u> Thallium	<u>82Pb</u> Lead	<u>83Bi</u> Bismuth	<u>84Po</u> Polonium	<u>85At</u> Astatine	<u>86Rn</u> Radon

Transition Elements									
<u>21Sc</u> Scandium	<u>22Ti</u> Titanium	<u>23V</u> Vanadium	<u>24Cr</u> Chromium	<u>25Mn</u> Manganese	<u>26Fe</u> Iron	<u>27Co</u> Cobalt	<u>28Ni</u> Nickel	<u>29Cu</u> Copper	<u>30Zn</u> Zinc
<u>39Y</u> Yttrium	<u>40Zr</u> Zirconium	<u>41Nb</u> Niobium	<u>42Mo</u> Molybdenum	<u>43Tc</u> Technetium	<u>44Ru</u> Ruthenium	<u>45Rh</u> Rhodium	<u>46Pd</u> Palladium	<u>47Ag</u> Silver	<u>48Cd</u> Cadmium
<u>57La</u> Lanthanum	<u>72Hf</u> Hafnium	<u>73Ta</u> Tantalum	<u>74W</u> Tungsten	<u>75Re</u> Rhenium	<u>76Os</u> Osmium	<u>77Ir</u> Iridium	<u>78Pt</u> Platinum	<u>79Au</u> Gold	<u>80Hg</u> Mercury

Lanthanides						
<u>58Ce</u> Cerium	<u>59Pr</u> Praseodymium	<u>60Nd</u> Neodymium	<u>61Pm</u> Promethium	<u>62Sm</u> Samarium	<u>63Eu</u> Europium	<u>64Gd</u> Gadolinium
<u>65Tb</u> Terbium	<u>66Dy</u> Dysprosium	<u>67Ho</u> Holmium	<u>68Er</u> Erbium	<u>69Tm</u> Thulium	<u>70Yb</u> Ytterbium	<u>71Lu</u> Lutetium

Actinides		
<u>90Th</u> Thorium	<u>91Pa</u> Protactinium	<u>92U</u> Uranium

Michael Wiplich at the Tandem Van de Graaff Accelerator located at the Brookhaven National Laboratory prepared the electronic version of the Negative-Ion Cookbook. The original paper version was converted to electronic form using an H.P. Scanjet 6200C scanner and H.P. Precision-Scan Pro OCR software followed by manual fix up in MS Word 2000 Pro which was also used to convert the document to HTML.

Please address any comments, suggestions or corrections to mwiplich@bnl.gov.

A Negative-Ion Cookbook

Roy Middleton

Department Of Physics, University of Pennsylvania

Philadelphia, PA 19104

October 1989 (Revised February 1990)

A Negative Ion Cookbook

Acknowledgements

The author is particularly grateful to the National Science Foundation who, for many years, has supported the Tandem Accelerator Laboratory at the University of Pennsylvania and made possible close to two decades of negative-ion source development. Many people have participated and contributed and it is a pleasure to acknowledge Mr. Paul Harduk for superbly crafting and building all the many ion sources. My thanks are also due to Mr. Charles T. Adams who participated extensively in the early development work and, more recently, to Mr. Harry White for his many contributions and his assistance with the measurements reported here. I would also like to thank Jeff Klein for many stimulating discussions and Mrs. Karen Walter for typing and editing this manuscript.

BNL's Contribution

This document was produced at the Brookhaven National Laboratory Tandem Van de Graaff Accelerator in response to our own need to have a readily available copy of the document that would not deteriorate with age and use. We were also responding to requests by members of the SNEAP mailing list for Internet access to the Cookbook.

Our original cookbook was a spiral-bound document and our copy was beginning to show excessive wear and tear. It was decided that the entire document would be converted to electronic form. MS Word was chosen as the word processor because of its ability to produce properly formatted HTML 4 documents for use on the Internet and to retain the original in the popular and easily accessed .doc format.

Michael Wiplich prepared the electronic version. The original paper version was converted to electronic form using an H.P. Scanjet 6200C scanner and H.P. Precision-Scan Pro OCR software followed by manual fix up in MS Word 2000 Pro which was also used to convert the document to HTML for use on the internet.

If, in your use of the information contained in this document, you find any errors or omissions please bring these to the attention of:

Michael Wiplich
Brookhaven National Lab
59 Cornell Avenue
Building 901A
Upton, NY 11973
Voice Phone: 631 344 5468
Fax Phone: 631 344 4583
e-mail: mwiplich@bnl.gov

After review, they will be included in the document at our earliest convenience.

Thank you.

A Negative Ion Cookbook

Introduction

The present work was undertaken to provide a means of producing negative ion beams, of as wide a range of elements as possible, with particular emphasis on their suitability for injection into a tandem accelerator. Since currents greater than about 5 μA are apt to load most tandems and experimenters rarely require currents larger than 1 μA , our efforts have concentrated on producing currents in this range. We have also placed higher priority on convenience of production and reliability than on current.

Not all elements form stable negative ions, and in these cases it is necessary to use molecular ions. Molecular beams have two disadvantages in a tandem: 1) they reduce the final energy of the elemental ion, and 2) the coulomb explosion in the stripper foil can degrade the quality of the final beam. Both effects are minimized by choosing the lightest possible molecule, such as a hydride. Consequently, whenever possible, hydrides have been our first preference; but if difficult or inconvenient to make, we have turned to carbide, nitride, or oxide negative ions.

Since beams of rare isotopes such as ^{13}C , ^{17}O , ^{18}O , ^{36}S , and ^{48}Ca are often required in nuclear research, we have placed emphasis on developing efficient methods of producing micro-ampere beams of these. In the growing field of accelerator mass spectrometry, samples are often small and contain only $\sim 10^6$ atoms of the isotope of interest. Clearly, ionization efficiency is of paramount importance, and in several cases we have attempted to measure this quantity.

A Negative Ion Cookbook

Negative Ion Source

Some of the measurements reported here were made with a source of the type described by Middleton¹) and shown in Figure 1 (this is commonly known as a high-intensity source). However, most were made with a source in which a spherical one replaced the cylindrical ionizer and a directed spray conveyed the cesium vapor to it. This eliminates the need for cesium vapor containment, and the inner source chamber could be dispensed with -- a significant advantage with gas cathodes. Figure 2 shows details of the ionizer, the electric field shaping shroud, the cesium spray, and the cathode insulator assembly. The ionizer, which is made from molybdenum, has a radius of 17.5 mm and an outside diameter of 25 mm. The negative ion exit hole in the center of the ionizer is 5 mm. in diameter.

We do not wish to discuss here the relative merits of the cylindrical and spherical ionizer sources; suffice it to say that negative ion currents rarely differ by more than a factor of two. The most significant feature of the spherical ionizer source is that the Cs^+ beam is much better focused and concentrated, and this undoubtedly results in improved emittance. However, there are other effects that we don't presently fully understand. For example, the negative ion currents and ionization efficiencies are very dependent upon the creation of a deep sputter crater and the formation of an intense plasma ball. It is also likely that this plasma is responsible for the production of 2 or 3 μA of $^{133}\text{Cs}^-$ ions -- but strangely only with cathodes of aluminum and iron (see Cesium).

Figure 1: The high-intensity sputter source developed by Middleton¹ in 1982.

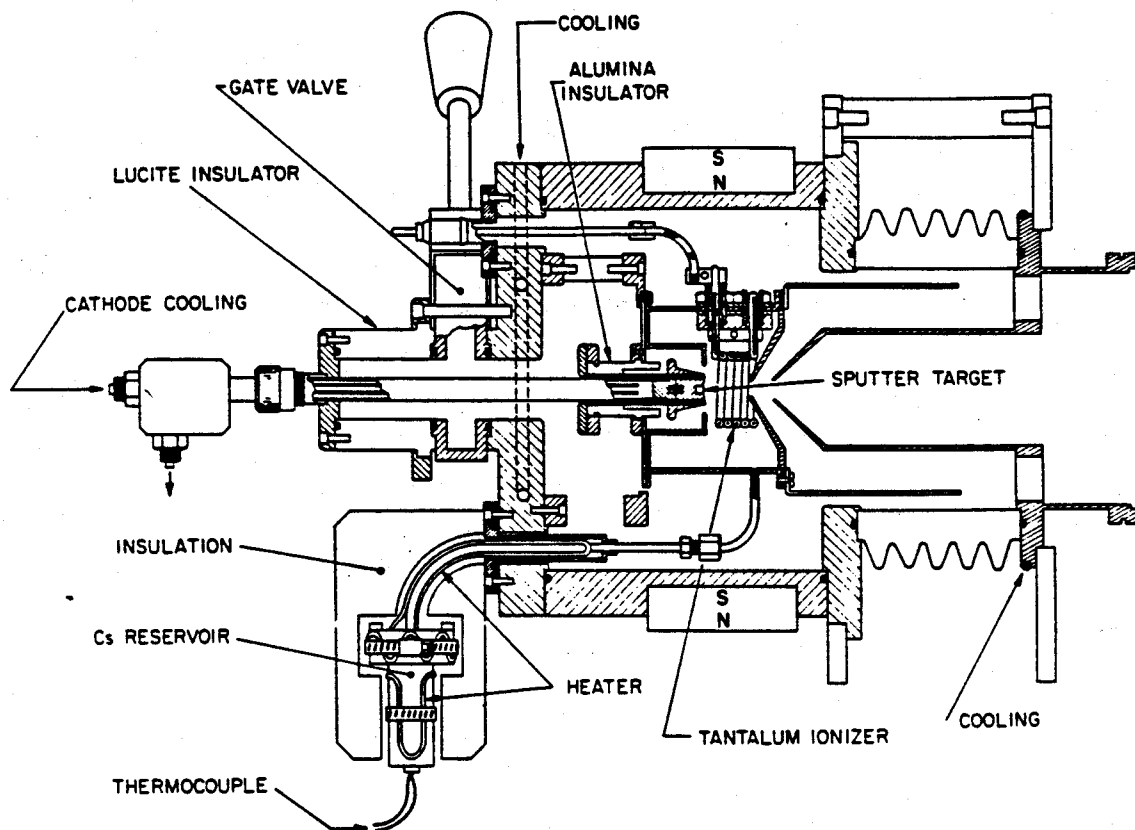

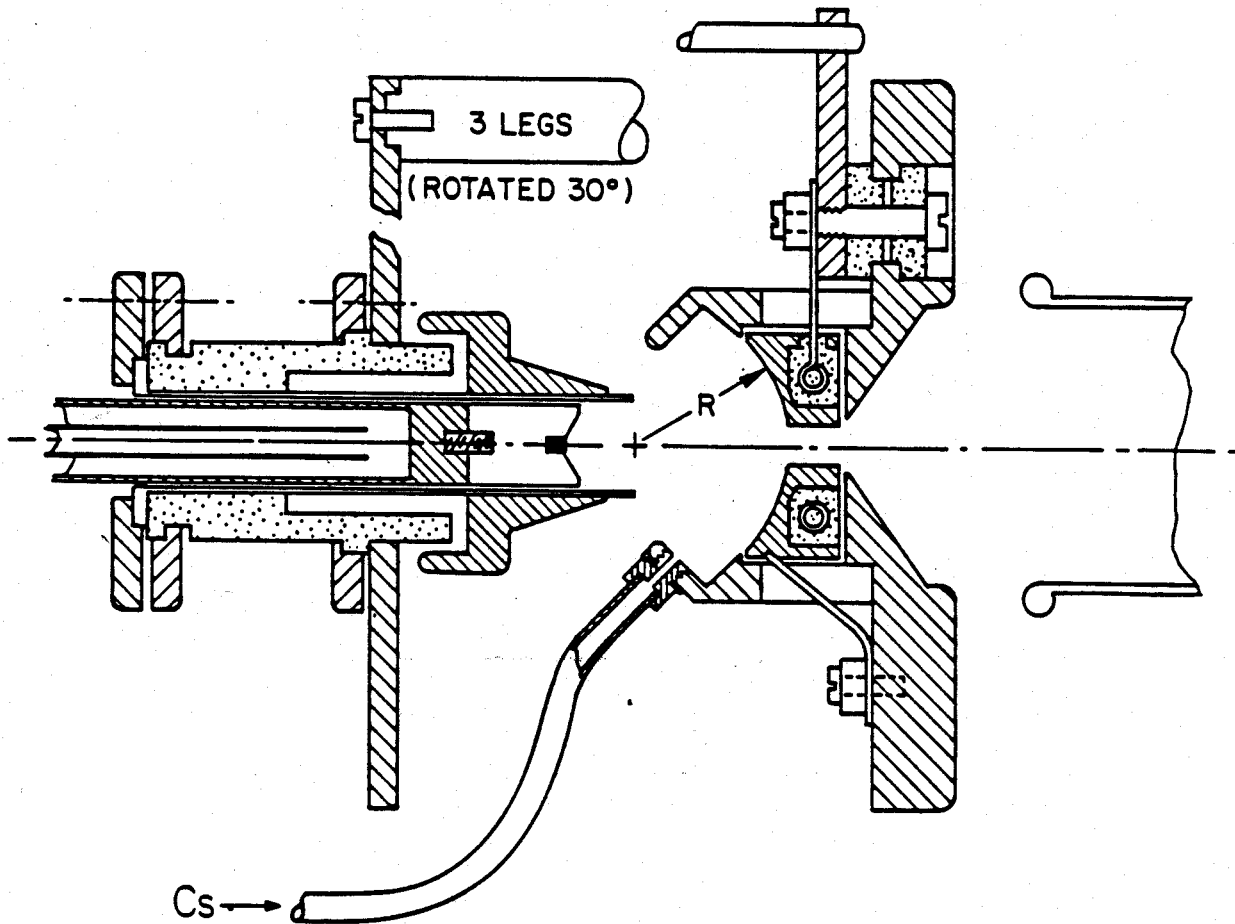

Figure 2: The modified high-intensity source that was used to make most of the measurements reported here. Major changes include a spherical ionizer and a spray system for the cesium vapor that eliminates the need for a cesium confinement chamber surrounding the cathode.

References

- 1) R. Middleton, Nucl. Instr. And Methods **214** (1983) 139

A Negative Ion Cookbook

Operating Conditions and Procedures

Almost all of the measurements reported here were made on the ion source test facility shown schematically in Figure 3. The major components are a 7.5 cm diameter decelerating einzel lens, adjustable object and image slits, a 30 cm radius double focusing 90° magnet, and an electrically suppressed Faraday cup. The test stand is pumped by a combination of cryo- and ion-pumps, and the vacuum during operation is typically 2 to 3×10^{-7} Torr.

We normally operate the spherical ionizer source with a cathode voltage of 8 kV as compared with 6 kV used with cylindrical ionizers. At this voltage, and with the optimum flow of cesium vapor, the Cs^+ current is between 1 and 1.5 mA but the cathode current (the current supplied by the cathode power supply) is usually between 2 and 5 mA. The latter is larger because it includes the electrons emitted by the cathode, most of which are deflected by external permanent magnets and strike the ionizer. The magnitude of the electron current depends on the cathode material and on the development of a sputter crater in the cathode. Usually this forms within 10 or 20 minutes, depending on the cathode, and generally is accompanied by the formation of a small ball of bright (often pale blue) plasma.

The ionizer current and voltage are typically 12.5 A and 9 V respectively and at this power the ionizer temperature is ~ 1100 °C. However certain cathode materials, such as the rare earth metals, are apt to stick on the surface of the ionizer and because of their low work functions, impair its efficient operation. With these we frequently increase the ionizer power to ~ 200 Watts, raising the temperature to about 1250 °C -- a dangerously high value. The cesium reservoir temperature is measured by a thermocouple screwed in its base. Since this is not thermally insulated, the temperature reading corresponds to the lowest value of the reservoir and cesium vapor feed tube. The temperature is manually controlled and is usually maintained between 180 and 195 °C.

Most measurements were made with an extraction voltage of 12 kV corresponding to a negative ion energy of 20 keV. Increasing the latter to 20 or 25 kV reduces the size of the beam envelope and, after magnetic analysis, increases the measured negative ion current by 15 to 20%. Also most currents were measured with the object slits of the 90° magnet generously open, but with the image slits at ± 4.0 mm or ± 1.25 mm, depending on the required mass resolution. With the larger opening about 90% of the beam is admitted, but at ± 1.25 mm the transmitted current is reduced by a factor of about 2.5. Most elements with mass > 80 , which passes two or more isotopes, were measured with the narrower slit opening.

It has become our practice, after a major source overhaul and whenever we have doubts about the operation of the source, to make test measurements with a pre-drilled (see Cathode Preparation) copper cathode. Assuming that the cesium reservoir is at its optimum temperature, the instantaneous $^{63}\text{Cu}^-$ current (measured through image slits at ± 4 mm) should be around 60 μA . Usually, but not always, this current falls to about 50 μA and then slowly climbs back to its initial value after 40 or 50 minutes. If the source is in excellent condition the $^{63}\text{Cu}^-$ current will grow to > 80 μA after 1 ½ to 2 hours of operation and the cathode current will be ~ 1.8 mA.

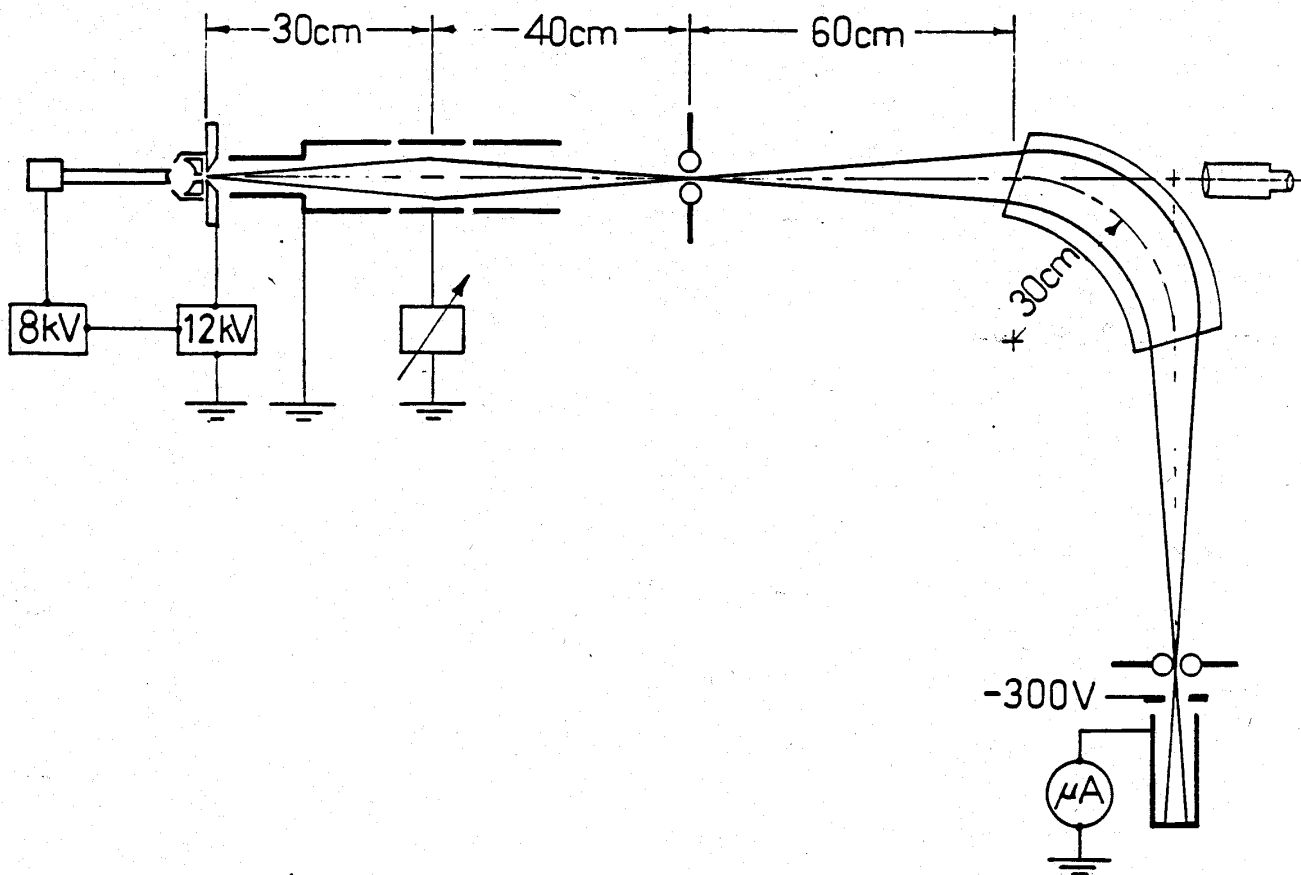

Figure 3: A schematic drawing of the ion source test facility used to make the present measurements. Usually the object slits were set at ± 7.5 mm and the image slits at either ± 3 mm or ± 1.25 mm, depending upon resolution requirements. At the latter value, the transmitted current is reduced by a factor of about 2.5.

A Negative Ion Cookbook

Cathode Preparation

It is our practice to purchase cathodes in lots of several thousand from a local manufacturer. These are made from oxygen-free high-conductivity copper according to the sketch shown on the left in Figure 4, with the exception that the 1.6 mm diameter hole in the front is drilled only 1.6 mm. deep. Of particular importance is the threaded bottom, which must be flat and free from burrs so that good thermal contact can be achieved when screwed to the cathode stem. To assist with this we usually tighten the cathode with pliers.

The top of the cathode has a conical depression that in part serves as an immersion lens to focus the negative ions, and also as a cup to hold powders and to facilitate their loading. To make a powder cathode we usually drill the central hole in the cathode 4 or 5 mm deep and then use the tamping tool, shown in Figure 4, to compress and hammer the powder into the hole. We wish to emphasize that it is inadequate to merely press a powder into a cathode and that it is essential to hammer it. Many powders, particularly of oxides and the like, benefit by first mixing with a fine silver powder. This frequently makes them run more steadily and causes the negative ion current to rise more quickly, but usually results in a lower final current.

The cathode shown on the right of Figure 4 illustrates how we make cathodes from metals that we usually purchase as 3 to 6 mm diameter rod. First the 1.6 mm diameter hole is extended completely through the cathode and then it is drilled 4 or 5 mm deep slightly smaller than the diameter of the rod. A 6 or 7 mm long piece of rod is forced into the hole (usually in a vise) and then the entire front of the cathode is dressed and finished with a specially ground drill bit -- as shown by the dashed curve in Figure 4. Finally, a 1 mm, diameter hole is drilled 1.3 to 1.5 mm deep into the metal insert as shown in the sketch. This last operation, which we refer to as "pre-drilling", is very important and causes the current to rise more quickly and increases the ionization efficiency (see the section on Ionization Efficiency).

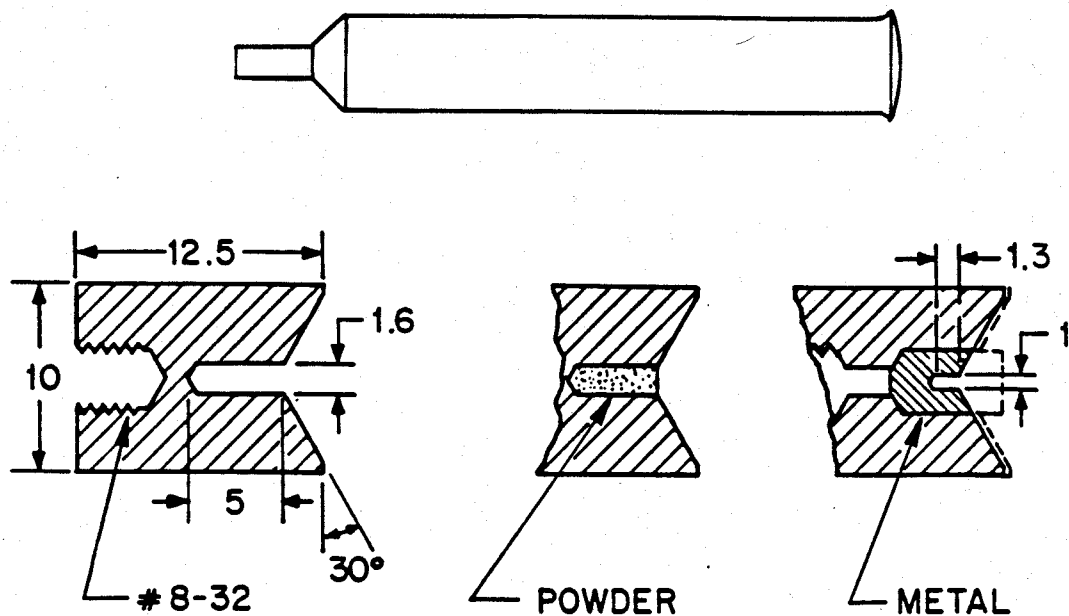

Figure 4: From left to right: a standard copper cathode blank, the same cathode filled with powder, and a cathode modified to accept a piece of metal rod (all dimensions are in millimeters). Note that the metal cathode has a pilot hole 1 mm diameter by 1.3 mm deep-this pre-drilling very significantly reduces the time that it takes the negative-ion current to build-up. Above the cathodes is the tamping tool that, quite literally, is used to hammer powders into cathode.

A Negative Ion Cookbook

Gas Cathodes

One of the advantages of the spherical ionizer source and cesium spray system is that it is particularly well suited for use with gas cathodes. However, since the latter are less convenient to use than solid cathodes, we have whenever possible sought a solid cathode. On occasions the gas cathode provides the only viable means of producing a negative ion beam and one such case is with magnesium hydride. Figure 5 shows part of the gas stem and the type of cathode that we have used with hydrogen and ammonia and found very effective for producing beams of $^{24}\text{MgH}^-$ and $^{24}\text{MgH}_3^-$. The same cathode, with ammonia, produces excellent currents of NH^- . We have experimented with more complicated gas cathode configurations but the extremely simple arrangement shown in Figure 5 is quite effective.

A brief description of the gas cathode stem was presented in reference 2 and the only significant change that has been made since then was to replace the 1 mm bore gas feed tube with one of 3 mm diameter. Gas is normally contained in a glass flask of about 250 cc capacity at a pressure of about 500 Torr. The flask and the metering needle valve (Edwards) are both mounted on the end of the cathode stem and are at cathode potential (20 kV, in our case). The needle valve is manually operated via a Lucite control rod.

Reference

- 2) R. Middleton, Nucl. Instr. And Methods **233** (1984) 193

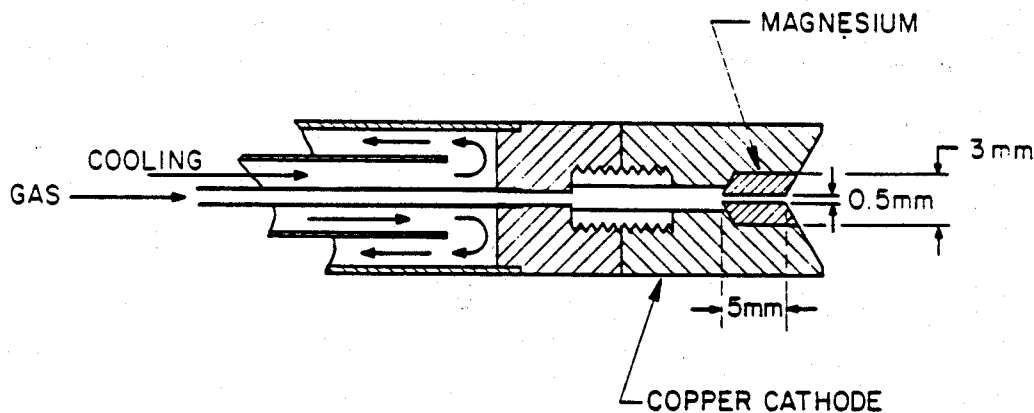

Figure 5: The gas cathode with a magnesium insert that was used with ammonia to produce intense beams of $^{24}\text{MgH}^-$, $^{24}\text{MgH}_3^-$ and NH^- ions.

A Negative Ion Cookbook

Ionization Efficiency

The ionization efficiency of an element or a compound is of considerable importance in accelerator mass spectrometry and also to those interested in accelerating rare isotopes. We define the quantity as the number of negative ions divided by the total number of sputtered particles expressed as a percentage. In principle it is a simple quantity to measure but in practice, particularly with the spherical ionizer source, measurement is complicated by a fairly strong dependence on sputter crater development.

Figure 6 shows the negative ion current from a cathode containing a piece of iron, measured at 10-minute intervals. Since the iron was not pre-drilled, the $^{56}\text{Fe}^-$ current grew very slowly at first and significant growth only began at the end of 30 minutes. After 90 minutes, when the $^{56}\text{Fe}^-$ current was close to a maximum, the cathode was removed, washed in distilled water and alcohol, dried and weighed. It had lost 8.9 mg of iron or approximately 9×10^{19} atoms. While in the source the integrated negative ion current was 16,900 μC or 1.06×10^{17} ions of $^{56}\text{Fe}^-$, corresponding to an ionization efficiency of 0.11%. The cathode was returned to the source and two similar measurements were made over successive 90-minute intervals. During these the efficiency increased to 0.71% over the first period and to 0.92% during the second.

The upper graph in Figure 7 contrasts the rate of growth of $^{63}\text{Cu}^-$ current from a plain cathode (full curve) with that from a pre-drilled cathode (dashed curve). The difference, particularly during the first hour, is striking and demonstrates the advantages of pre-drilling. After each 15-minute interval of operation the cathodes were removed, washed, and weighed, and the ionization efficiencies were calculated. These are shown graphed as a function of time in the lower half of Figure 7. There can be little doubt that pre-drilling not only speeds the rate of current growth but also improves the ionization efficiency.

It is evident from the foregoing that measuring ionization efficiency is not a simple task and the techniques used with iron and copper cannot be applied to compounds such as calcium hydride. Here we have adopted a simpler and more practical approach of loading a known weight of the compound and operating the cathode to almost total completion. Although providing a less accurate value, at least the result is relative and of practical significance.

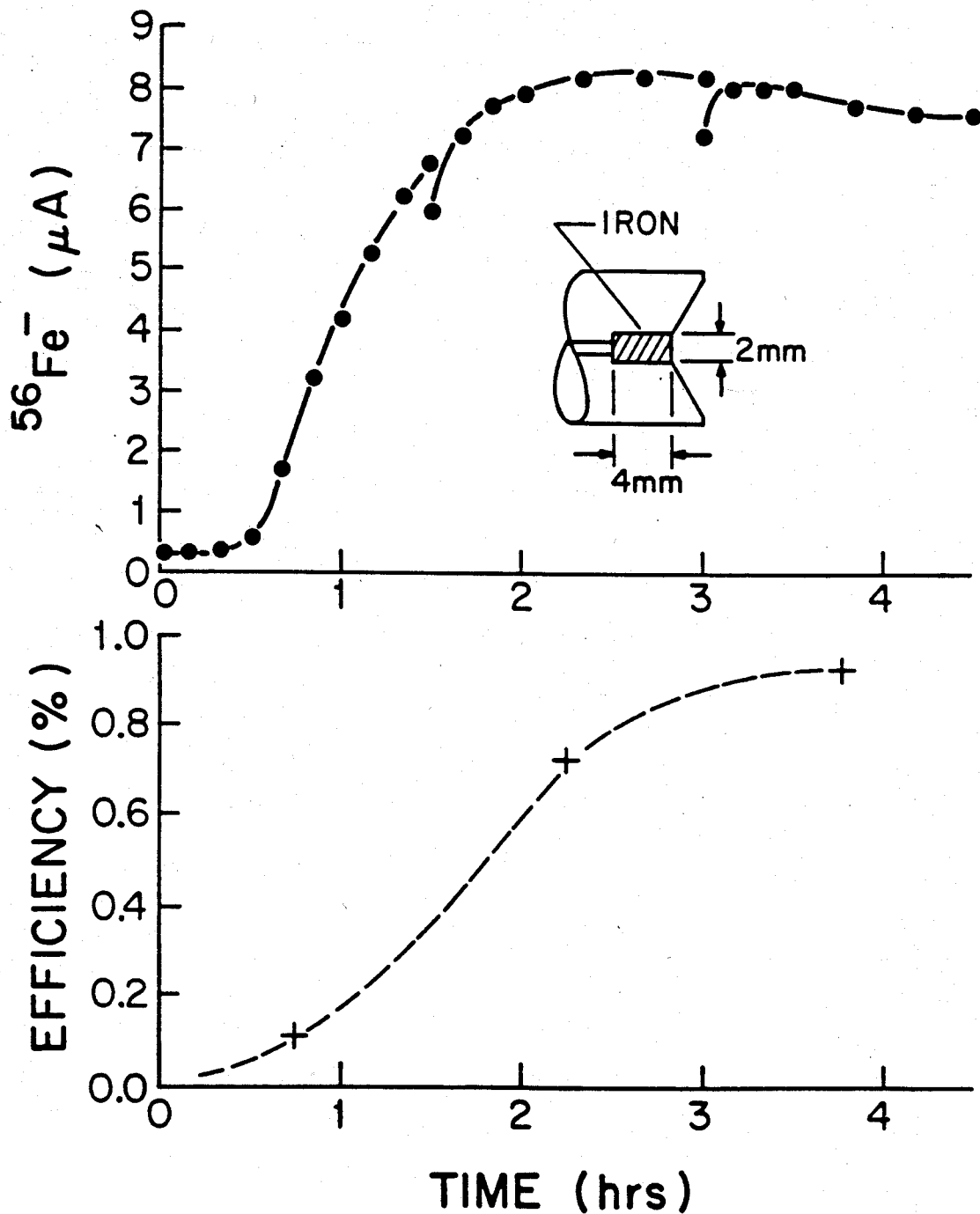

Figure 6: The upper graph shows the rate of growth of the $^{56}\text{Fe}^-$ current from an iron cathode that had not been pre-drilled. Every 90 minutes the cathode was removed from the source and the amount of sputtered iron was determined by weighing. From this the ionization efficiency was calculated and is shown plotted in the lower graph. Note the marked increase in the negative ion current and the ionization efficiency that occurs as the sputter crater forms in the cathode.

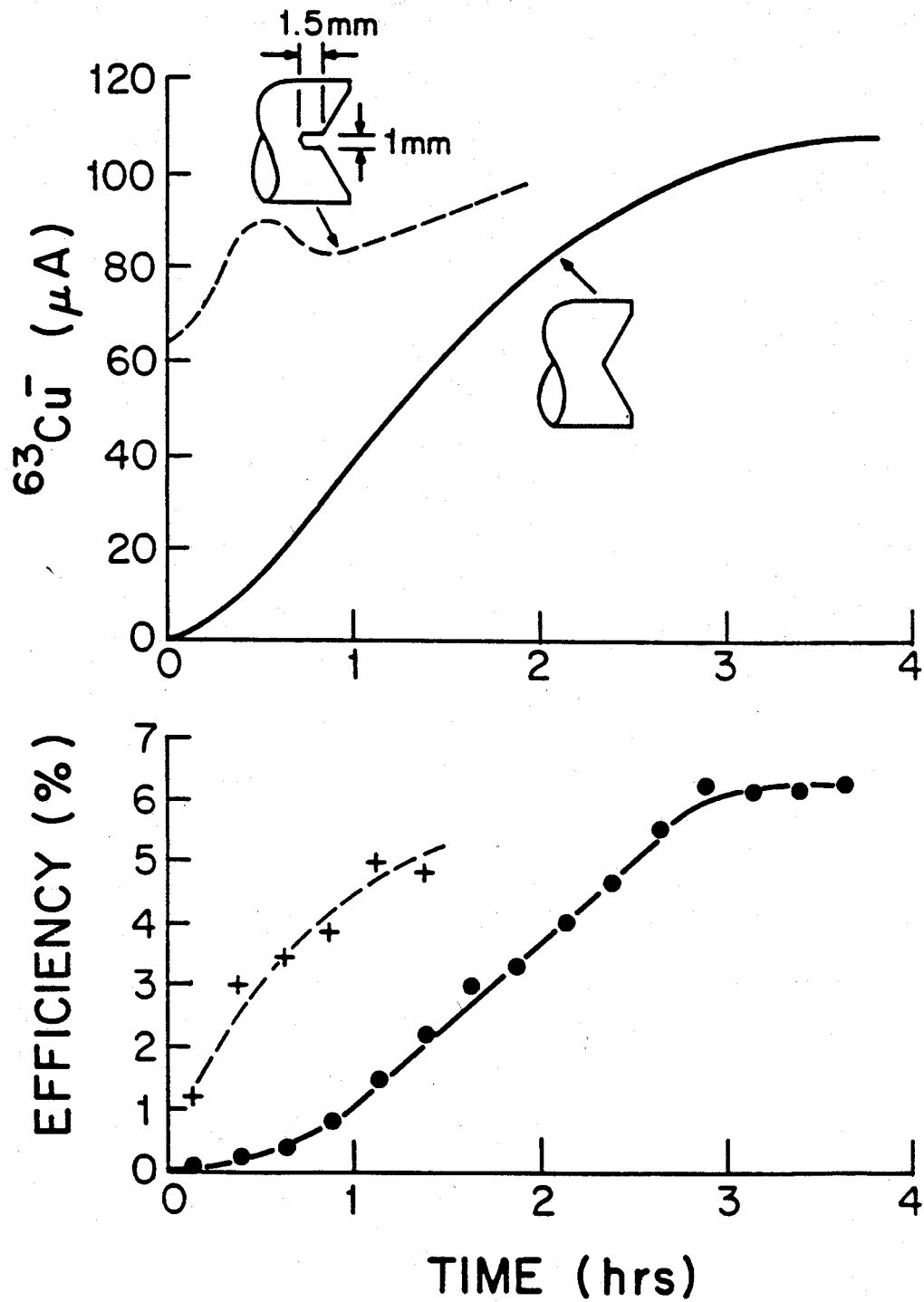

Figure 7: The upper graph contrasts the rate of growth of current from a plain copper cathode with that from one that has been pre-drilled. Below are shown the ionization efficiencies of these two cathodes measured intervals of 15 minutes (the dashed line corresponds to the pre-drilled cathode).

A Negative Ion Cookbook

Source Maintenance and Cleaning

The frequency with which a high-intensity source should be serviced and cleaned depends on the level of operation and the type of ion. Under favorable circumstances this might be several hundreds of hours, but with ions such as BeO^- , which we tend to run at maximum intensity (10 to 12 μA), maintenance may be necessary at intervals of 120 to 150 hours.

The items most likely to require cleaning are the cathode insulator and the ionizer (cylindrical or spherical). These are best cleaned by micro blasting with an abrasive such as aluminum oxide grit. We have tried many methods, but none performed as well as micro blasting, particularly with ionizers. Other components of the inner source, which are mainly made of stainless steel, are usually cleaned by soaking for a few minutes in a weak nitric acid solution. This efficiently removes most build-ups of sputtered copper, but usually leaves a loosely bound black scum on the surface that we remove by scrubbing with Scotch-brite under flowing water. The components are then dried and given a final wipe with a tissue soaked with alcohol and then reassembled. The inside of the extract electrode insulator rarely needs more than a brief wipe with a moistened tissue.

Periodically, usually following one or more vacuum failures, we find it necessary to increase the reservoir temperature to 220 to 250 °C in order to obtain cathode current. The most likely cause is a blocked cesium vapor tube. This can easily be checked by removing the reservoir and poking a thin piece of springy wire down the feed tube. If blocked, the only recourse is to open the reservoir in a dry box. The chances are that it will still contain cesium metal and that the blockage has been caused by a black crusty deposit on the reservoir lid and extending into the cesium feed tube. We usually discard the leftover cesium, wash and clean the reservoir and feed tube, and re-load with a 5 gm charge of cesium metal.

A Negative Ion Cookbook

Toxicity of Cathode Materials

Many of the cathode materials that we have used are toxic and some are reactive to the point of being explosive. Since we lack expertise on these matters we have made very few references to potential dangers and we strongly suggest that anyone following our procedures consult an appropriate treatise or at least read the literature on potential hazards supplied by the vendor of the chemicals.

A Negative Ion Cookbook

Ionization Potentials and Electron Affinities of the Elements

IA	IIA	IIIA	IVA	VA	VIA	VIIA	VIIIA
₁H 13.59 0.754	Ionization Potential Electron Affinity						₂He 24.48 0.078*
₃Li 5.39 0.618	₄Be 9.32 0.195*	₅B 8.30 0.277	₆C 11.26 1.263	₇N 14.53 -0.07	₈O 13.61 1.461	₉F 17.42 3.399	₁₀Ne 21.56 < 0
₁₁Na 5.14 0.548	₁₂Mg 7.64 < 0	₁₃Al 5.98 0.441	₁₄Si 8.15 1.385	₁₅P 10.48 0.747	₁₆S 10.36 2.077	₁₇Cl 13.01 3.617	₁₈Ar 15.76 < 0
₁₉K 4.34 0.501	₂₀Ca 6.11 0.043	₃₁Ga 6.00 0.30	₃₂Ge 7.90 1.2	₃₃As 9.81 0.81	₃₄Se 9.75 2.021	₃₅Br 11.81 3.365	₃₆Kr 14.00 < 0
₃₇Rb 4.18 0.486	₃₉Sr 5.70 < 0	₄₉In 5.79 0.3	₅₀Sn 7.34 1.2	₅₁Sb 8.64 1.07	₅₂Te 9.01 1.971	₅₃I 10.45 3.059	₅₄Xe 12.13 < 0
₅₅Cs 3.89 0.472	₅₆Ba 5.21 < 0	₈₁Tl 6.11 0.2	₈₂Pb 7.42 0.364	₈₃Bi 7.29 0.946	₈₄Po 8.42 1.9	₈₅At 9.5 2.8	₈₆Rn 10.75 < 0

*Metastable

Transition Elements									
₂₁Sc 6.54 0.188	₂₂Ti 6.82 0.079	₂₃V 6.74 0.525	₂₄Cr 6.77 0.666	₂₆Mn 7.44 <0	₂₆Fe 7.87 0.163	₂₇Co 7.86 0.661	₂₈Ni 7.64 1.156	₂₉Cu 7.73 1.228	₃₀Zn 9.39 <0
₃₉Y 6.38 0.307	₄₀Zr 6.84 0.426	₄₁Nb 6.88 0.893	₄₂Mo 7.10 0.746	₄₃Tc 7.28 0.55	₄₄Ru 7.37 1.05	₄₆Rh 7.46 1.137	₄₆Pd 8.34 0.557	₄₇Ag 7.58 1.302	₄₉Cd 8.99 < 0
₅₇La 5.58 0.5	₇₂Hf 7.0 ~0	₇₃Ta 7.89 0.322	₇₄W 7.98 0.815	₇₅Re 7.88 0.15	₇₆Os 8.7 1.1	₇₇Ir 9.1 1.565	₇₉Pt 9.0 2.128	₇₉Au 9.22 2.309	₈₀Hg 10.44 <0

Lanthanides †							
₅₈Ce 5.47 0.5	₅₉Pr 5.42 0.0	₆₀Nd 5.49 -0.3	₆₁Pm 5.55 -0.3	₆₂Sm 5.63 0.3	₆₃Eu 5.67 -0.3	₆₄Gd 6.16 0.5	
₆₅Tb 5.85 0.5	₆₆Dy 5.93 -0.3	₆₇Ho 6.02 -0.3	₆₈Er 6.10 -0.3	₆₉Tm 5.18 0.3	₇₀Yb 6.25 -0.3	₇₁Lu 5.43 0.5	

Actinides ‡		
₉₀Th 6.95 0.5	₉₁Pa ? 0.3	₉₂U 6.08 0.3

† Theoretical values of electron affinities from: Electron Affinities of the Lanthanides S.G. Bratsch, Chem. Phys. Lett., 98(2) 113-117 (1983).

‡ Theoretical values of electron affinities from: Electron Affinities of the Actinides, S.G. Bratsch and J.J. Lagowski, Chem. Phys. Lett., 107(2) 136-140 (1984).

A Negative Ion Cookbook

^1H Hydrogen

Isotopes

^1H - 99.985%, ^2H - 0.015%

Physical Properties

E.A. - 0.754 eV, I.P. = 13.595 eV, m.p. – gas

Cathodes

Several metallic hydrides such as titanium (TiH_2), calcium (CaH_2), strontium (SrH_2), zirconium (ZrH_2), etc. have been tried and all produce prolific H^- beams. We have also produced very intense beams from gas cathodes such as magnesium, calcium, and titanium with either ammonia or hydrogen gas.

Recommended Cathode

For convenience titanium hydride is an excellent choice, particularly since it is commercially available. We use 325-mesh powder and hammer it into a standard cathode -- it looks quite metallic after hammering. We have also made cathodes by absorbing hydrogen in a small "pill" of titanium metal, but because of the difficulty of mounting, and in particular heat sinking the pill, we now almost exclusively use the powder.

For deuterium we make our own titanium deuteride. A small quantity of 100-mesh titanium powder is heated in a deuterium atmosphere at a pressure of about 600 Torr, using the apparatus developed to make calcium hydride (see Calcium). At a temperature of about 500-600 °C the titanium powder visibly brightens indicating the exothermic absorption of the deuterium. Cathodes prepared from this material produce negative deuterium beams fully comparable to H^- .

Performance

The H^- current from a titanium cathode usually starts around 20 μA , climbs to 50 to 60 μA in 30 minutes and levels off around 100 μA after about 1 hour. Cathode lifetime, even at these high currents, is typically 4 to 5 hours. Recently the H^- current from a cathode containing 3.7 mg of titanium hydride was measured at regular intervals over a period of 6.5 hours and is shown graphed on the following page. The integrated current, prior to the H^- current falling below 20 μA was $9 \times 10^5 \mu\text{C}$ and corresponds to an ionization efficiency of 6.4%.

Molecular Ions

H_2^- and H_3^- are reported to be stable and we have searched for these using a cathode loaded with deuterium. As can be seen in the spectrum shown overleaf, a weak peak was observed corresponding to D_2^- , but none was observed corresponding to D_3^- . The ratio of D_2^- to D^- is about 2.3×10^{-6} , and an upper limit on the D_3^- to D^- is about 10^{-6} . Molecular beams containing hydrogen are commonplace and almost all elements form a hydride with the possible exception of the halogens. The hydride beams are frequently more intense than the elemental beams and in some cases, such as nitrogen and magnesium, provide the lightest stable negative ion.

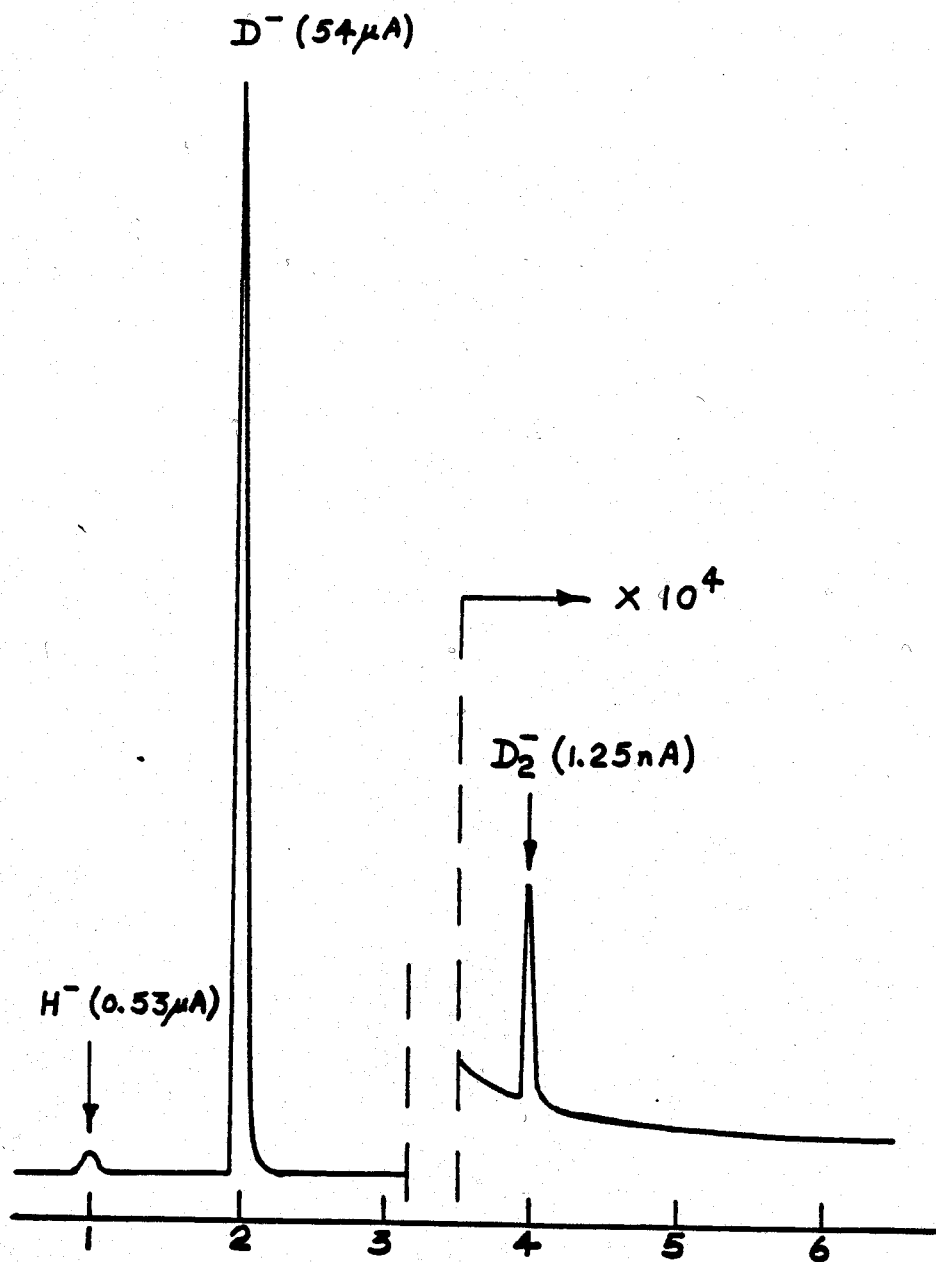

Portion of a negative ion spectrum obtained with a cathode loaded with 100% enriched deuterium. Note the presence of a very weak peak corresponding to D_2^- and the complete absence of D_3^- . The $D_2^- : D^-$ ratio is about 2.3×10^{-6} .

A Negative Ion Cookbook

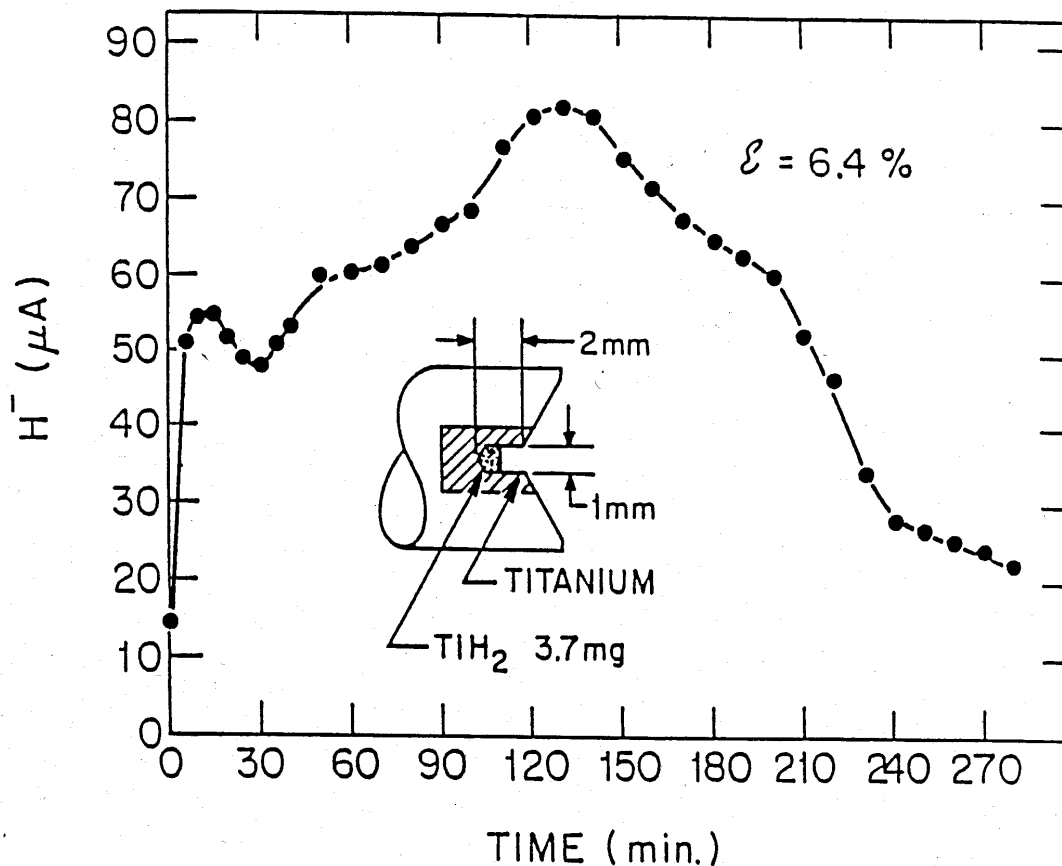

Showing the H^- current from a cathode (see inset sketch above) containing 3.7 mg of titanium hydride measured as a function of time. The total integrated current, prior to the H^- current falling below 20 μA , was $9 \times 10^5 \mu C$ and corresponds to an ionization efficiency of 6.4%. These measurements were made with a high-intensity source with a spherical ionizer.

A Negative Ion Cookbook

${}_{2}\text{He}$

Isotopes

${}^3\text{He}$ - 0.00014%, ${}^4\text{He}$ - 99.99986%

Physical Properties

E.A. < 0 (metastable, bound by 0.077 eV), I.P. = 24.48 eV, M.P. – gas

Cathodes

On a few occasions we have tried to make ${}^4\text{He}^-$ ions in a cesium sputter source using a titanium gas cathode and helium gas. Although we succeeded, the currents were extremely small ($\sim 10^4$ counts per second), and of no practical value.

A Negative Ion Cookbook

${}^3\text{Li}$

Isotopes

${}^6\text{Li}$ - 7.5%, ${}^7\text{Li}$ - 92.5%

Physical Properties

E.A. = 0.618 eV, I.P. = 5.39 eV, m.p. = 180 °C, W.F. ~ 2.9eV

Cathodes

An obvious choice is lithium metal and this has been tried and found generally unsatisfactory. Usually the initial Li^- current is reasonably good, 2 to 3 μA , but over 30 minutes or so this falls to a steady value of about 0.5 μA . Numerous experiments have confirmed that the large initial current is due to surface layers of oxide (and/or hydroxide) and once sputtered away the negative ion current falls. Indeed, sustained Li^- currents of 3 or 4 μA have been obtained from a lithium metal gas cathode fed with a small amount of oxygen. However, a more convenient procedure is to use a cathode prepared from LiOH as described below.

Cathodes have also been prepared from lithium hydride (LiH), lithium amide (LiNH_2), lithium fluoride (LiF), lithium sulfide (Li_2S) and lithium nitride (Li_3N). The first four performed reasonably satisfactorily but the Li^- currents were usually less than 2 or 3 μA (lithium amide was primarily studied as a source of NH^- ions - see Nitrogen). The lithium nitride performed significantly better and produced steady currents in the 5 to 8 μA range - it is however a reactive material and requires careful handling.

Recommended Cathode

By far the most satisfactory cathode material that we have encountered is lithium hydroxide prepared from lithium metal. We usually cut a small (50 to 100 mg) piece of metal (frequently separated isotope), place it on a heavy metal block and ignite it with a propane torch. The lithium burns emitting intense white light and leaves a white powdery residue (this is best done in a fume hood). Further heating melts the residue that usually condenses into a ball of clear liquid that turns white on cooling. Since the melting point of Li_2O is 1700 °C and that of LiOH is 450 °C, we believe that the end product is the hydroxide. The cooled pellet is rapidly crushed, with a small mortar and pestle, mixed with a small amount of silver powder and pressed and hammered into a standard cathode (speed is important since the hydroxide is hygroscopic).

Performance

Typical lithium hydroxide cathodes tend to run unsteadily and even when mixed with silver powder are not completely steady. Usually the Li^- current rises very quickly and we frequently observe 3 or 4 μA almost immediately and 6 to 8 μA within 15 minutes. Cathode lifetime is good and usually 4 to 8 hours depending on the negative ion current. A typical negative ion spectrum from such a cathode is shown overleaf.

Molecular Ions

The molecular negative ions of lithium are far from prolific. The dimer ion, Li_2^- , is usually present but with only 2 or 3% the intensity of the monomer. The trimer is even weaker but is stable. The oxides are also relatively weak and two are identified in the spectrum on the facing page. LiN^- was not positively identified in spectra obtained with cathodes containing lithium amide and nitride - if it exists it is very weak.

To verify the existence of hydrides we prepared a cathode from lithium hydride. The latter was prepared by heating lithium metal in the presence of hydrogen (see Calcium and the preparation of calcium hydride). A portion of a spectrum obtained with this cathode is shown on the facing page. It is evident that lithium has two hydrides, the stronger being the dihydride, but neither are as intense

A Negative Ion Cookbook

as the elemental ion. The fluorides of lithium are generally similar to the hydrides with LiF_2^- dominating LiF^- but in this case, LiF_2^- is stronger than Li^- (see Fluorine - spectrum from lithium fluoride).

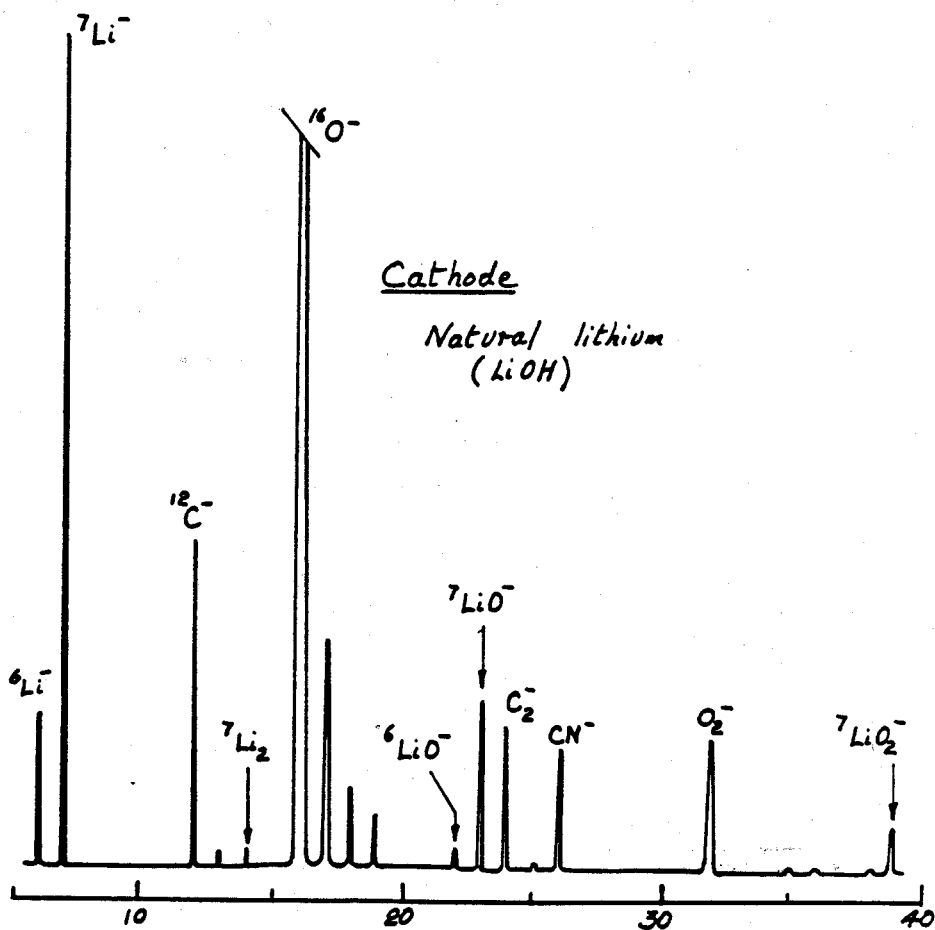

Negative-ion spectrum obtained from a cathode containing a mixture LiOH and silver powder. In addition to the strong peak corresponding to ${}^7\text{Li}^-$ ($\sim 7 \mu\text{A}$) weaker peaks are identified corresponding to ${}^7\text{Li}_2^-$, ${}^7\text{LiO}^-$ and ${}^7\text{LiO}_2^-$.

A Negative Ion Cookbook

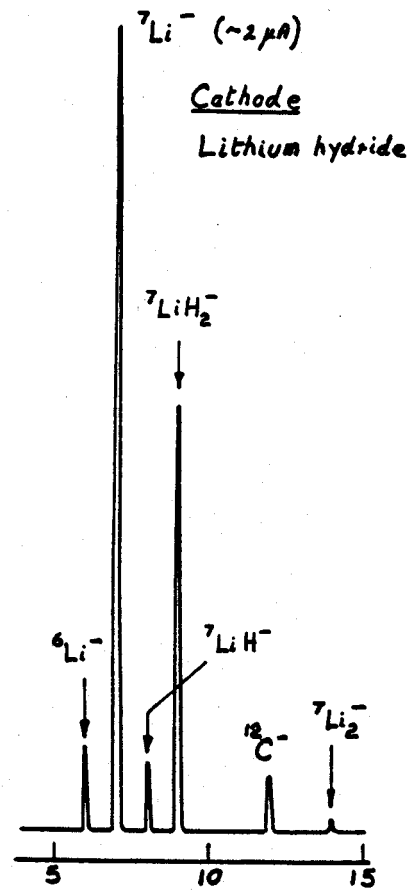

A spectrum obtained using a cathode containing lithium hydride. Lithium appears to form two hydride negative ions, LiH^- and LiH_2^- -- the latter being the more intense.

A Negative Ion Cookbook

4Beryllium

Isotopes

⁹Be - 100%

Physical Properties

E.A. = 0.195 * eV, I.P. = 9.32 eV, m.p. = 1278 °C, W.F. = 4.98 eV

* metastable

Cathodes

Largely because beryllium and many of its compounds are toxic relatively few tests have been performed. We have made a few measurements with beryllium metal gas cathodes and ammonia. Like other alkaline earth metals, beryllium forms mono-, di-, and tri-hydride negative ions and it is relatively easy to obtain 1 to 2 μA of ${}^9\text{BeH}^-$ ions. (${}^9\text{BeH}_2^-$ is much weaker and usually ${}^9\text{BeH}_3^-$ is obscured by ${}^{12}\text{C}^-$). A more convenient cathode material is beryllium oxide (BeO) which typically produces 5 to 10 μA of BeO^- and 0.1 to 0.2 μA of ${}^9\text{Be}^-$ ions.

Recommended Cathode

Beryllium oxide. We have used this material on numerous occasions and usually compress 5 to 10 mg of BeO powder, without silver, into a 1.6 mm diameter hole in a standard cathode. We have never used sintered material but suspect from our experience with alumina that this would not be satisfactory.

Performance

Cathodes prepared without silver usually take between 15 and 30 minutes to attain maximum current and frequently last for 3 to 5 hours. One cathode, which was weighed before and after, produced $1.68 \times 10^5 \mu\text{C}$ of BeO^- ions from 2.8 mg of oxide. This corresponds to an ionization efficiency of about 1.6%. Typical currents of BeO^- are $\sim 8 \mu\text{A}$ accompanied by about 100 μA of ${}^{16}\text{O}^-$ and 0.1 to 0.2 μA of ${}^9\text{Be}^-$. Since ${}^9\text{Be}^-$ is reported to be metastable we were rather surprised to observe such a large current from a sputter source and to verify its identification we ran the beam through our FN tandem. The transmission of ${}^9\text{Be}^{4+}$ ion at 7.3 MV was 36% - this is excellent, suggesting that the half-life of the elemental negative ion is much larger than 10 μs . A typical negative ion spectrum from a cathode containing beryllium oxide is shown overleaf.

Molecular Ions

The only molecular ions that we have observed are the hydrides and oxides. These include BeH^- , BeH_2^- , BeH_3^- , BeO^- , BeO_2^- , Be_2O^- and Be_2O_2^- . We have no evidence for the existence of a dimer (Be_2^-) but owing to the presence of ${}^{18}\text{O}^-$, this would be difficult to observe.

A Negative Ion Cookbook

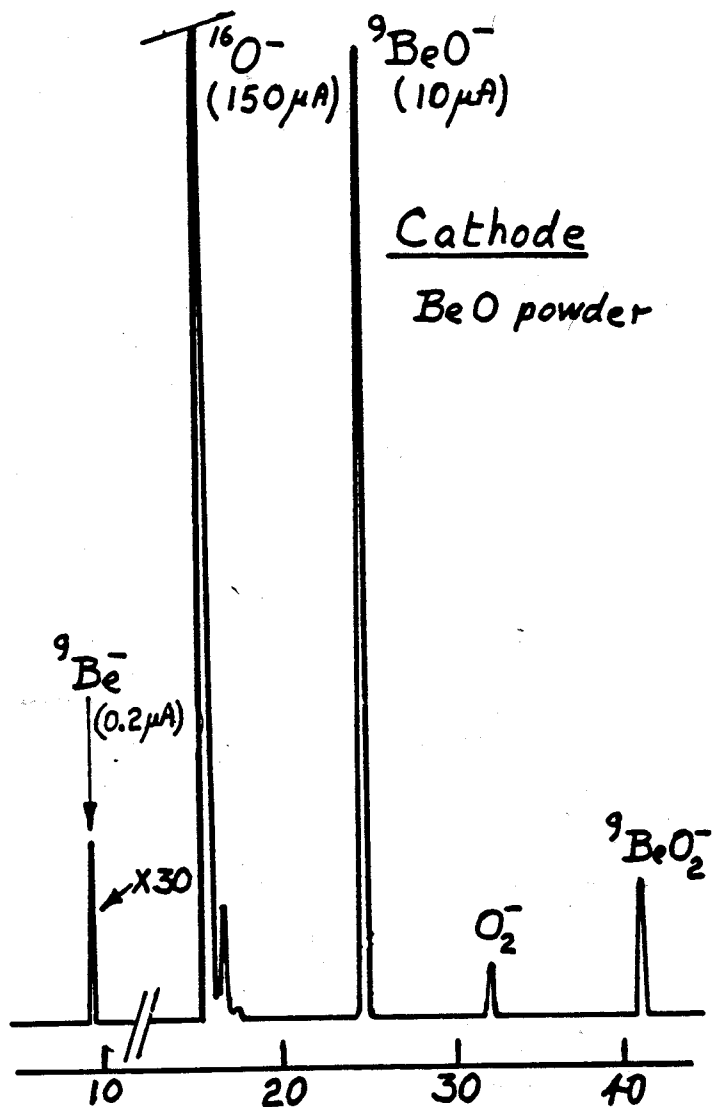

A typical negative ion spectrum obtained from a cathode containing beryllium oxide powder. These usually give between 6 and 12 μA of ${}^9\text{BeO}^-$ and 0.15 to 0.25 μA of ${}^9\text{Be}^-$ ions. The latter is thought to be metastable but we have successfully accelerated it through our tandem.

A Negative Ion Cookbook

${}_5\text{Boron}$

Isotopes

^{10}B - 19.8%, ^{11}B - 80.2%

Physical Properties

E.A. = 0.277 eV, I.P. = 8.30 eV, m.p. = 2079 °C, W.F. = 4.45 eV

Cathodes

Because of widespread interest in obtaining large negative-ion currents we have tried many cathode materials including crystalline boron, sintered boron, boron carbide, boron nitride, boron oxide, lanthanum hexaboride, etc. In addition, since separated boron isotopes are available as elemental powders, we have attempted making cathodes by pressing the powder either alone or mixed with some other metal powder.

By far the best material is boron crystal, but since it is usually only available in irregularly shaped pieces it is difficult to mount with good thermal contact to the copper cathode. We have tried a variety of schemes including wrapping in indium foil and "setting" in soft solder or type metal.

Provided good contact is achieved such cathodes perform well and we have obtained 80 μA of $^{11}\text{B}^-$ -- a remarkable current for an element with an electron affinity of only 0.28 eV.

Recommended Cathode

We prefer to make boron cathodes by pressing a mixture of boron and silver powder into a standard cathode. This is convenient and quick and has the advantage that cathodes can be made from isotopically enriched ^{10}B or ^{11}B that is readily available as an elemental powder. The addition of silver (about 1:1 by volume) is extremely important and increases the negative-ion current by a factor of 5 or more (we believe the silver improves the thermal conductivity).

Performance

Cathodes prepared from compressed boron and silver powder usually give 10 to 12 μA of the elemental ion almost instantaneously, climbing to - 20 μA in 30 minutes and 30 to 40 μA after an hour or two. It is noteworthy that the negative-ion current is unusually dependent on cathode voltage (i.e. the Cs^+ energy) and we have frequently increased the current by 50% or more by raising the voltage from the normal 8 kV to 10 kV. Although cathodes prepared from boron crystal will produce more current they are very slow rising presumably because it takes a long time to form a sputter crater. Overleaf is shown a negative ion spectrum from a boron/silver powder cathode.

Molecular Ions

Boron, like carbon, has several polyatomic negative ions and the dimer frequently rivals the elemental ion in intensity (see spectra on facing page). BO^- is also quite prolific but its intensity is clearly determined by the oxygen content of the cathode. Other weaker oxide beams are BO_2^- and B_2O^- . Measurements made with cathodes prepared from sintered boron carbide and mixtures of boron and powdered graphite reveal the existence of BC^- and BC_2^- ions -- the former is the stronger but it is usually weaker than the elemental ion. No evidence has been obtained for hydrides but these would be difficult to observe in the presence of carbon.

A Negative Ion Cookbook

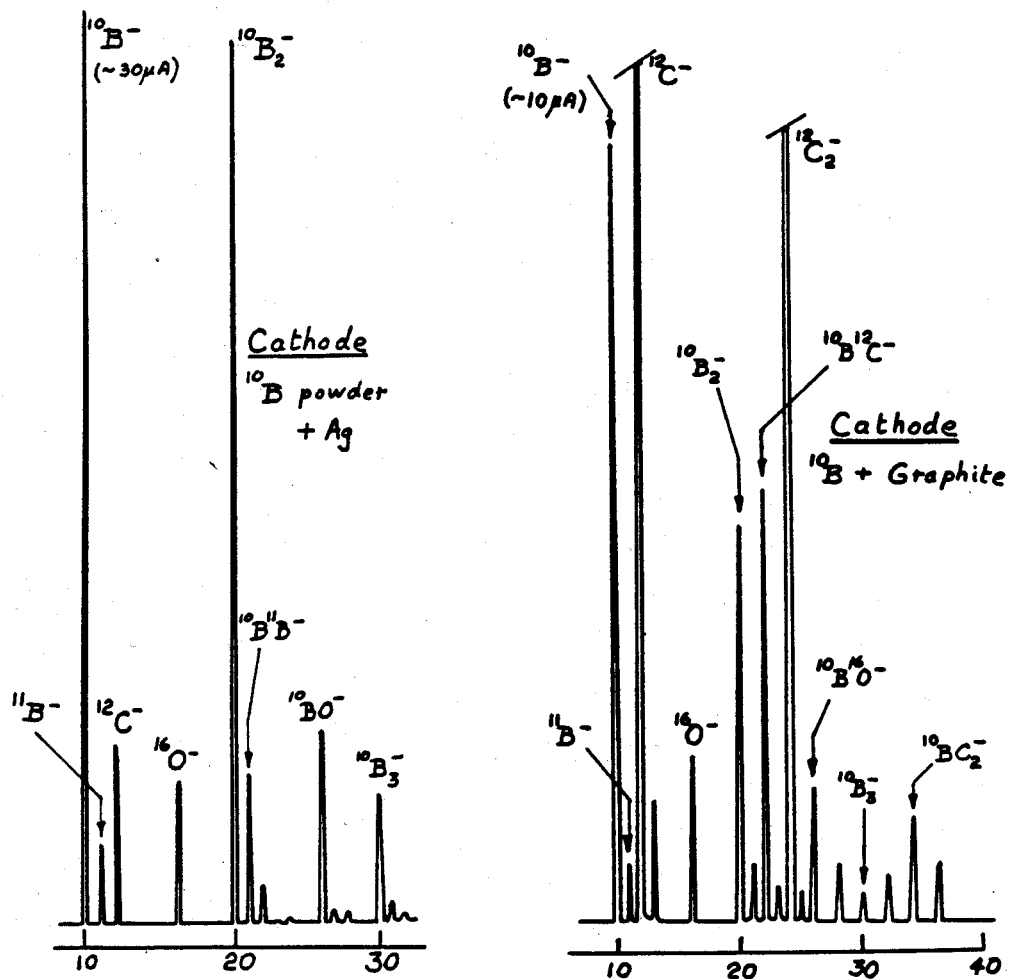

The spectrum on the left was obtained from a cathode containing separated ^{10}B and silver powder (about 1:1 by volume). The inclusion of silver is very important and increases the elemental current by about a factor of 5. The spectrum on the right is from a cathode containing a mixture of separated ^{10}B powder and powdered graphite.

A Negative Ion Cookbook

${}^6\text{C}$ Carbon

Isotopes

${}^{12}\text{C}$ - 98.89%, ${}^{13}\text{C}$ - 1.11%

Physical Properties

E.A. = 1.263 eV, I.P. = 11.26 eV, m.p. = 3350 °C, W.F. = 5.0 eV

Cathodes

Carbon is a very prolific negative ion and almost any non-carbon cathode in a high intensity source produces 100 nA or more. It arises either as a cathode contaminant or due to residual hydrocarbons in the source vacuum and, indeed, is difficult to eliminate. Graphite is an excellent cathode material since it is readily available, machines easily, and reliably produces ${}^{12}\text{C}^-$ currents of at least 100 μA . Interest in alternative cathode materials largely results from the need to accelerate ${}^{13}\text{C}$ and from radiocarbon dating. Our interests in the latter prompted the development of a source capable of generating 20 to 30 μA of the ${}^{12}\text{C}^-$ from CO_2 gas¹. Also we have developed a technique for preparing cathodes from amorphous carbon, described below, resulting in currents of ~80 μA . The same process can be used to make cathodes capable of producing 100 μA of ${}^{13}\text{C}^-$ ions.

Recommended Cathode

As mentioned above graphite is by far the best choice and might also suffice as a 1 to 2 μA source of ${}^{13}\text{C}^-$ ions. However, a significant fraction of the mass 13 beam is usually ${}^{12}\text{CH}^-$ and it might be advantageous to use a cathode enriched in ${}^{13}\text{C}$. Isotopically enriched carbon is readily available in elemental form as a fine amorphous powder. The latter, which resembles lamp black, is a notoriously difficult cathode material but recently we developed a simple and highly effective method of incorporating it in a cathode. Typically we mix about 6 mg of ${}^{13}\text{C}$ powder with 30 mg of extremely fine nickel powder* using a mortar and pestle, and then hammer the mixture into a 1.6mm diameter hole, 3mm deep, in a standard copper cathode. After hammering the mixture appears metallic.

Performance

Graphite cathodes usually produce 100 μA or more almost immediately and thereafter the current slowly rises over a period of about an hour. We have noticed, particularly with the spherical ionizer source, that the current increases by as much as a factor of two when the cathode is pushed 2 or 3 mm forward. This increases the size of the sputter spot and the reduced Cs^+ intensity appears to favor negative ion formation. Recently a cathode containing 10 mg of graphite was run almost to completion, and prior to the ${}^{12}\text{C}^-$ current falling below 30 μA it produced $7.2 \times 10^6 \mu\text{C}$, corresponding to an ionization efficiency of about 9%. This may be compared with an efficiency of 7.7% measured with our CO_2 gas source.

Nickel/ ${}^{13}\text{C}$ powder cathodes also perform well and within minutes usually give 80 to 100 μA . A negative ion spectrum from such a cathode is shown overleaf. This particular cathode contained 6 mg of 96% enriched ${}^{13}\text{C}$ and produced about 100 μA for over 6 hours. The same technique has been successfully used to make cathodes from pyrolyzed wood, vegetation and biological tissue. An interesting characteristic of this type of cathode is that the yield of polyatomic ions is much less than from graphite.

A Negative Ion Cookbook

Molecular Ions

Carbon has an unusually large number of intense polyatomic negative ions whose intensities decrease rapidly with increasing mass - the even polymers being the strongest. The intensities of the polymers are variable and that of the dimmer can rival the elemental current but frequently it is about 50% of the latter. Usually, adjacent to the peak corresponding to C_{11}^- a weak peak can be identified corresponding to $^{133}Cs^-$. Above this mass the carbon polymers are very weak but strong peaks appear corresponding to CsC_2^- , CsC_4^- , CsC_8^- , etc. Some of the features of carbon's polyatomic negative ions are shown in the facing figure.

The hydrides of carbon definitely include CH^- and CH_2^- but we have never observed $^-CH_3$. The oxides are unusually weak and we have only occasionally observed CO_2^- and CO_3^- -we have never positively identified CO^- .

Reference

1) R. Middleton, J. Klein, and D. Fink, Nucl. Instr. and Methods (1989), in press.

* Nickel powder (957001), JM Specialty Products, Johnson Mat they, Orchard Road, Royston, Herts., SG8 SHE, England.

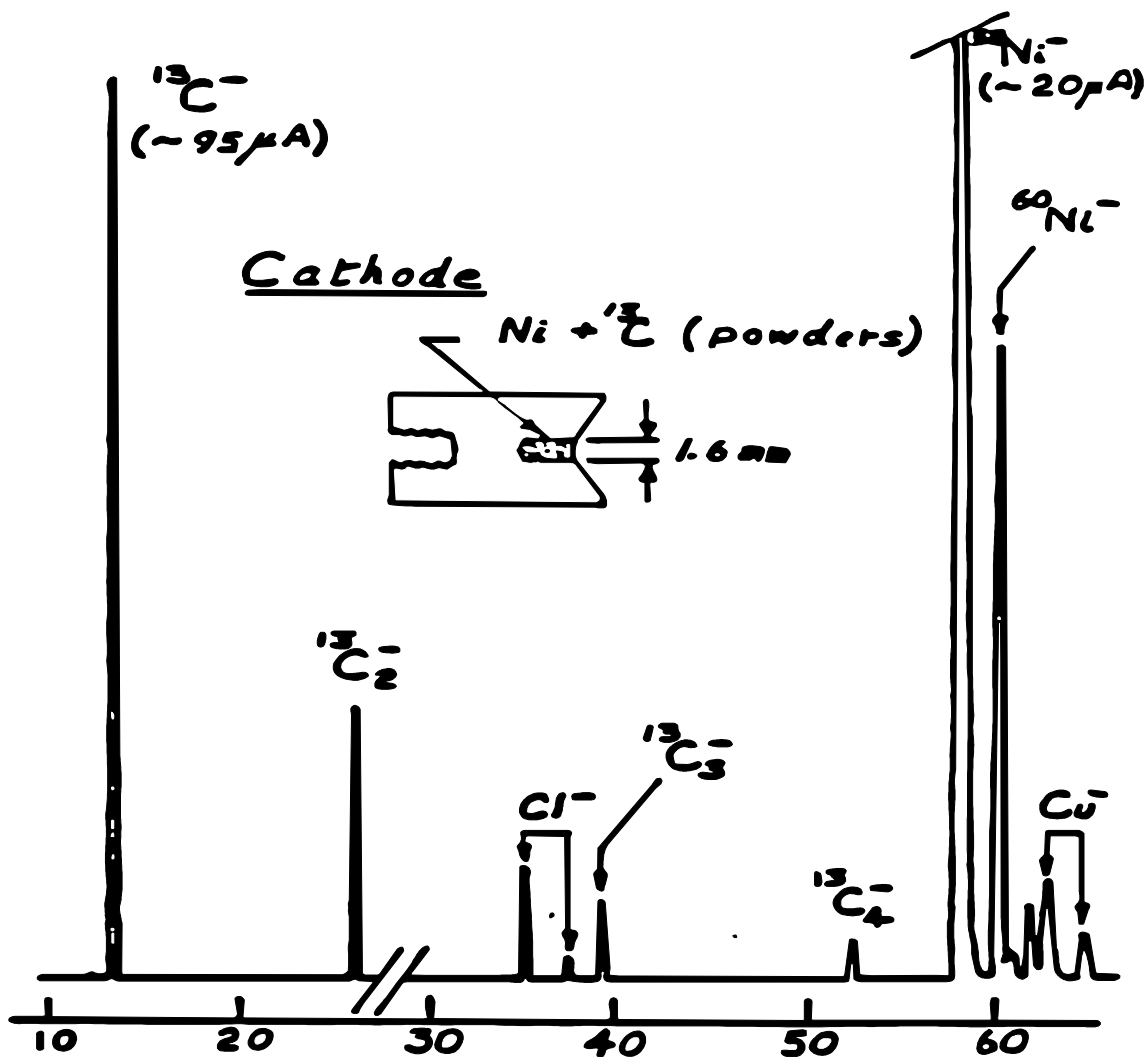

Spectrum of $^{13}\text{C}^-$. The cathode was prepared from about a 1 to 1 atom mixture of very fine nickel powder and separated ^{13}C powder. These cathodes perform well and frequently produce more than 100 μA of $^{13}\text{C}^-$.

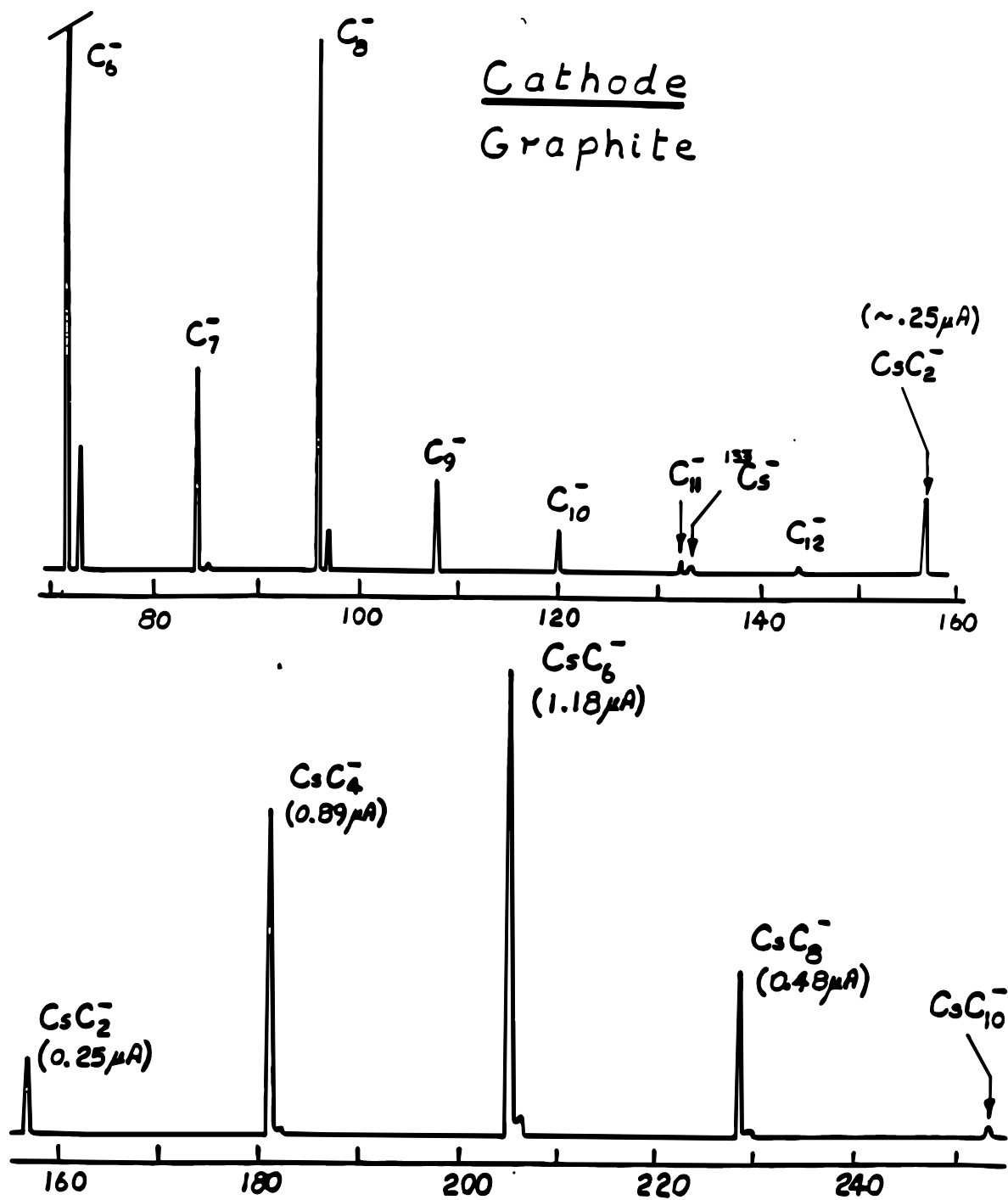

Showing some of the many polyatomic negative ions observed from graphite. Notice that the ions become progressively weaker with increasing mass and none are evident beyond C_{12}^- . However, a new molecular ion emerges; CsC_2^- , CsC_4^- , CsC_6^- , etc. The latter are quite intense and frequently CsC_4^- and CsC_6^- are $> 1 \mu A$.

A Negative Ion Cookbook

⁷Nitrogen

Isotopes

¹⁴N - 99.63%, ¹⁶N - 0.37%

Physical Properties

E.A. < 0, I.P. = 14.54 eV, m.p. = gas

Cathodes

Since nitrogen does not form a stable negative ion it can only be accelerated in a tandem as a molecule. If energy is an important consideration the molecule of choice should be light such as NH⁻ or NH₂⁻. Unfortunately these are difficult to form and the best way of proceeding depends on intensity considerations. Maximum current, (3 -5 nA) requires the use of a gas cathode, as described below, but modest currents of 100 to 300 μA can be observed more conveniently from a solid target such as lithium amide (LiNH₂) and mixtures of titanium nitride (TiN) and titanium hydride (TiH₂). If energy is not of major importance a more convenient and prolific source of nitrogen is the molecule CN⁻.

Recommended Cathode

CN⁻ is a very prolific negative ion and it is relatively easy to produce beams of 10 to 30 μA from a standard cathode filled with a mixture of graphite and boron nitride (BN) or titanium nitride (TiN). The former is particularly convenient since boron nitride and graphite are common laboratory materials and both can be powdered by rubbing on a file. The mixture is not very critical and we usually use roughly equal volumes.

The only way of producing more than 1 μA of NH⁻ that we are aware of is with a gas cathode. We have tried different gases and metals but by far the best combination is ammonia and magnesium. If 100 to 200 nA is an acceptable current we recommend a cathode made from a 1:1 by weight mixture of TiN and TiH₂ -- this performs as well as lithium amide and is more convenient to handle.

Performance

BN/graphite cathodes perform admirably and usually give 5 or 6 μA almost immediately, rising to 20 to 30 μA over 30 minutes. A typical negative ion spectrum from such a cathode is shown overleaf. The NH⁻ current from a gas cathode is very pressure dependent. We usually find the current maximum (~5 μA) when the base pressure (~10⁻⁷ Torr in our case) is raised by about 10⁻⁶ Torr. For a typical negative ion spectrum, see Magnesium. In this it may be noticed that the m=16 current is about 4 times stronger than NH⁻. Some of this is undoubtedly due to ¹⁶O⁻ and we are unsure of the NH⁻: NH₂⁻ ratio. We have had occasion to use TiN/TiH₂ cathodes on our tandem where the NH⁻ beam performed admirably providing about 35% transmission of ¹⁴N⁷⁺ at 7.5 MV. When mass 16 was injected the transmission was < 1% indicating that most of the beam was ¹⁶O⁻. It is noteworthy that the NH⁻ current from a TiN/TiH₂ cathode rises slowly and frequently takes over an hour to maximize.

Molecular Ions

The hydrides of nitrogen definitely include NH⁻ and NH₂⁻ but we have never observed NH₃⁻. Likewise we have never observed N₂⁻ or NO⁻ but suspect that the latter is stable. As already mentioned CN⁻ is a very prolific and common negative ion. It is likely that most metals form stable nitride ions but we have made no systematic search. However, we noticed considerably more than 1 μA of ⁴⁸TiN⁻ ions from a TiN/TiH₂ cathode and about 8 μA of TaN⁻ ions from a tantalum gas cathode and ammonia.

A Negative Ion Cookbook

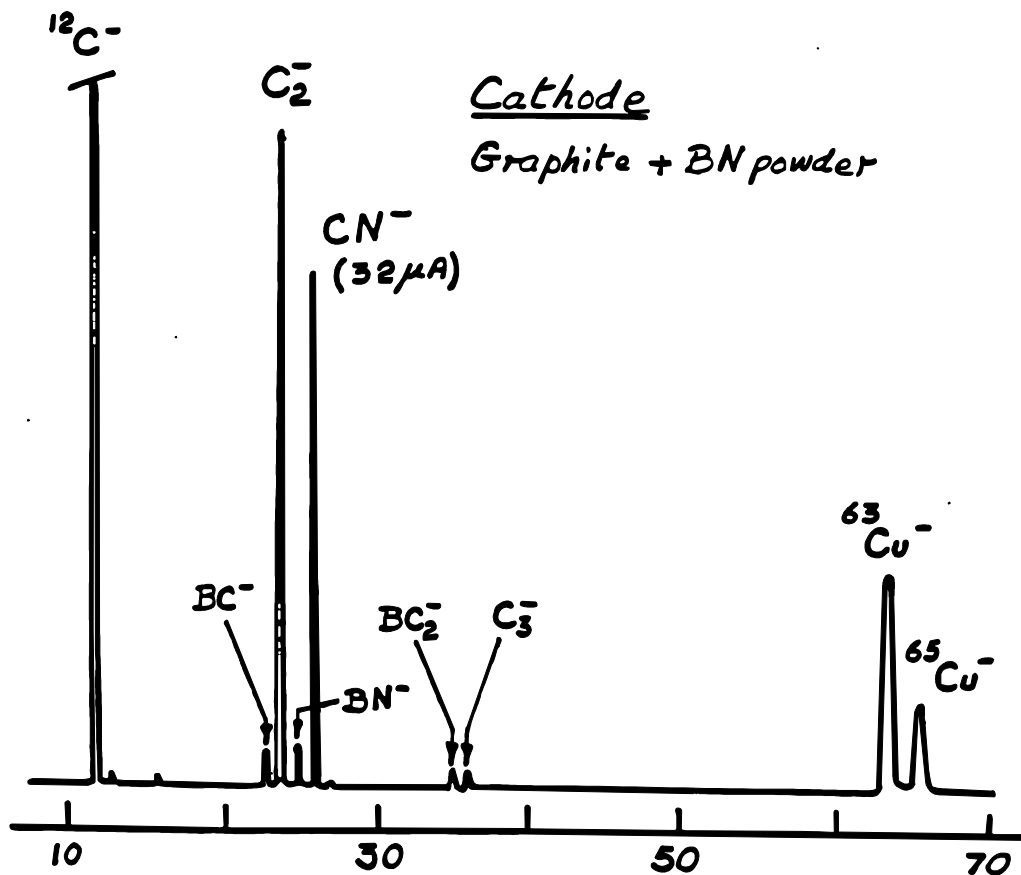

The simplest and most convenient way of accelerating nitrogen in a tandem is to use the molecular ion CN^- . The latter is a very prolific negative ion and can be made using a cathode containing a mixture of powdered boron nitride and graphite. Shown above is a typical negative ion spectrum obtained from a cathode of this type.

A Negative Ion Cookbook

⁸Oxygen

Isotopes

¹⁶O - 99.76%, ¹⁷O - 0.037%, ¹⁸O - 0.20%

Physical Properties

E.A. = 1.461 eV, I.P. = 13.61 eV, m.p. = gas

Cathodes

We have made measurements with at least 25 different oxides and all yield prolific ¹⁶O⁻ beams. However, some run smoothly while others perform erratically and often require the addition of silver powder. The rare earth oxides are particularly troublesome and in addition to producing large electron currents (which can damage the ionizer) they frequently contaminate and impair the operation of the ionizer.

Recommended Cathode

We have considerable experience with cathodes containing aluminum oxide (Al₂O₃) that we use in accelerator mass spectrometry studies. These perform quite well, don't require the addition of silver powder and usually produce 100 to 200 μA of ¹⁶O⁻. Also excellent performers are tungsten oxide (WO₃ or W₂O₆), magnesium oxide (MgO), and manganese dioxide (MnO₂) -- the last mentioned is particularly good.

It is not practical to obtain useful currents of ¹⁷O⁻ and ¹⁸O⁻ from oxygen of normal isotopic composition because of their low abundancies and the presence of moderately strong beams of ¹⁶OH⁻ and ¹⁶OH₂⁻. However, it is fairly simple to make enriched tungsten oxide and with such a cathode we have obtained more than 100 μA of ¹⁶O⁻. We prepare the oxide by heating a tungsten filament in a small volume bell jar filled with enriched oxygen at about 200 Torr pressure. A piece of aluminum foil placed under the filament catches the oxide, which falls like snow. At high pressures, where there is an excess of oxygen, the oxide is WO₃, which can be recognized by its canary yellow color. At considerably lower pressures the oxide sticks to the tungsten and must be scraped off. It is usually a gray-blue color and is predominantly W₂O₅.

Performance

The oxides mentioned above run quite well, do not require the addition of silver powder, and all usually produce almost instantaneously 50 to 100 μA of ¹⁶O⁻. Cathode lifetime clearly depends upon current, but a standard cathode drilled 4 or 5 mm deep will usually last for at least 2 or 3 hours.

Molecular Ions

As mentioned above, most oxide cathodes produce microampere currents of mass 17 and 18 ions that are mainly ¹⁶OH⁻ and ¹⁶OH₂⁻ -- we have never observed ¹⁶OH₃⁻. The oxygen dimer is invariably present in all spectra, but it is relatively weak with about 1 or 2% the strength of the elemental ion. We have never positively identified O₃⁻ -- if it exists it is extremely weak. Almost all elements form a stable negative oxide and most of the spectra reproduced in this work contain at least one such peak.

A Negative Ion Cookbook

9Fluorine

Isotopes

¹⁹F - 100%

Physical Properties

E.A. = 3.399 eV, I.P. = 17.42 eV, m.p. – gas

Cathodes

Since fluorine is such a prolific negative ion we have not tried many cathodes and most measurements have been made with lithium fluoride (LiF, m.p. 842 °C) or calcium fluoride (CaF₂ m.p. 1300 °C). We suspect that almost any fluoride can be successfully used.

Recommended Cathode

We like calcium fluoride and usually mix it with a little silver powder. The mixture compacts nicely in a cathode and runs steadily in the source, taking about 30 minutes to attain maximum current (100 to 200 μA). Since fluorine is so prolific we frequently run with a reduced cathode voltage.

Molecular Ions

The negative ion HF⁻ is either unstable or extremely weak and we have no evidence of its existence. However, fluorine does have a very weak dimer (F₂⁻) that is evident in the lithium fluoride spectrum shown overleaf. Usually the intensity of the dimer is 0.1 to 0.3% of the elemental ion. Also evident in the figure are peaks corresponding to LiF and LiF₂⁻, the latter being the strongest. Indeed, the spectra of lithium fluoride and lithium hydride (see Lithium) are quite similar, with the fluorine playing a hydrogen-like role. An even more marked similarity exists between the spectra of calcium fluoride and calcium hydride (see Calcium).

BNL TVDG Experience:

Fluorine is a very prolific beam. The standard fluorine parameters are stored in:
Tandem "File.... Load.... Standard.... Fluorine.72t"

A Negative Ion Cookbook

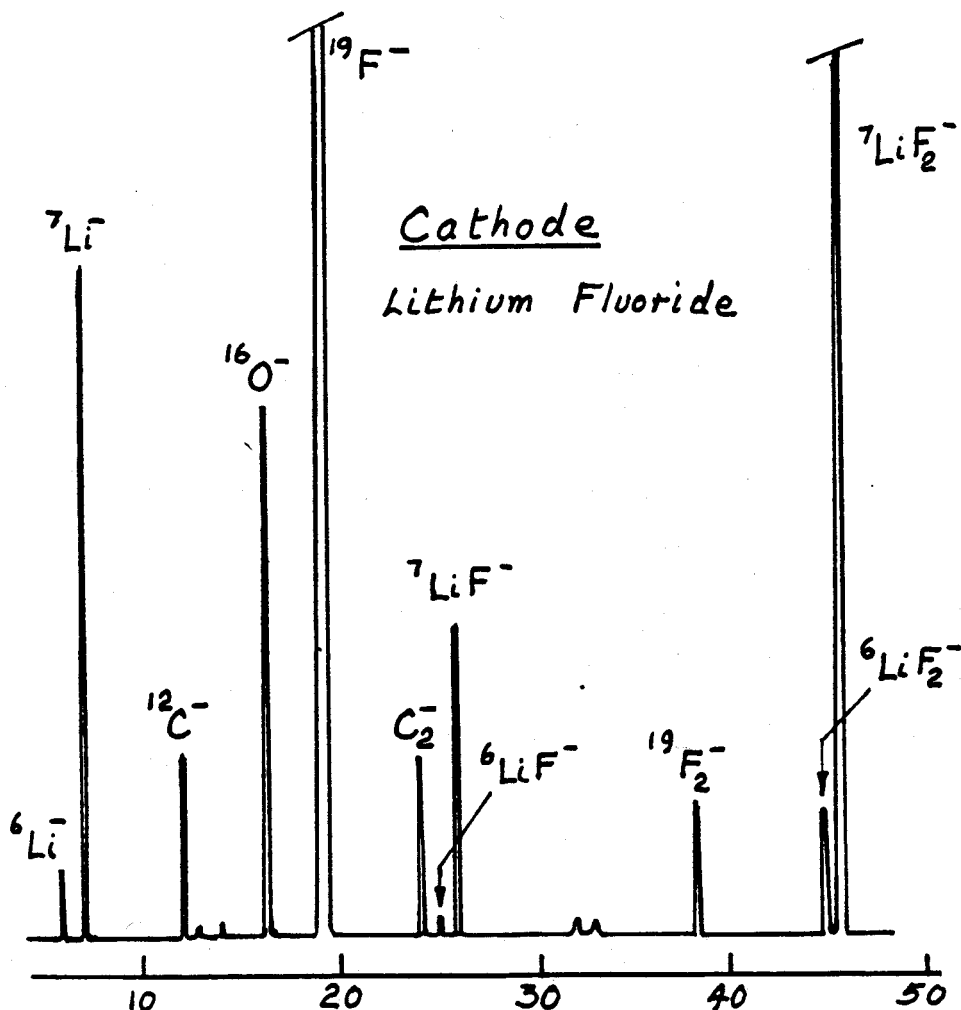

A negative ion spectrum obtained from a cathode containing lithium fluoride. Although we normally mix the lithium fluoride with silver powder, on this occasion silver was not used. In addition to the intense ${}^{19}\text{F}^-$ peak ($\sim 150 \mu\text{A}$) and the weak dimer ($\sim 0.2 \mu\text{A}$) note the peaks corresponding to ${}^7\text{Li}^-$, ${}^7\text{LiF}^-$, and ${}^7\text{LiF}_2^-$. The last three closely resemble the spectrum of lithium hydride (see Lithium).

A Negative Ion Cookbook

¹⁰Neon

Isotopes

²⁰Ne - 90.51%, ²¹Ne - 0.21%, ²²Ne - 9.22%

Physical Properties

E.A. < 0, I.P. = 21.56 eV, m.p. – gas

Like all of the noble gases, neon has a negative electron affinity and unlike helium does not appear to form a metastable negative ion. Since, to the best of our knowledge, there are no stable molecular ions, neon cannot be accelerated in a tandem.

A Negative Ion Cookbook

¹¹Sodium

Isotopes

²³Na - 100%

Physical Properties

E.A. = 0.548 eV, I.P. = 5.14 eV, m.p. = 97.8 °C, W.F. = 2.75 eV

Cathodes

The low melting point and high reactivity of the metal deterred us from using it in a cathode. Following our success with lithium we have prepared cathodes from ignited sodium metal, melted sodium hydroxide and melted sodium carbonate (Na₂CO₃). We have also used sodium chloride as a cathode material but primarily as a source of Cl⁻ ions.

Recommended Cathode

Melt a small piece of sodium hydroxide (NaOH, m.p. = 318 °C) on a heavy metal block and thoroughly degas and drive-off all excess water vapor. On cooling crush and mix with a little silver powder and rapidly load in a cathode. Sodium hydroxide is deliquescent and this operation must be done quickly or preferably in a dry box. We think that our earlier experiments involving burning sodium metal and heating sodium carbonate resulted in the formation of sodium hydroxide.

Performance

Sodium hydroxide without silver powder runs poorly and erratically, and even when mixed with silver steadiness is only marginal. Also we found cathodes to be unpredictable and two cathodes prepared in the same way frequently performed differently. A good cathode usually gave 1.5 to 2.5 μA of Na⁻ while the occasional poor cathode would barely produce 0.5 μA. Cathode lifetime is relatively short, about 3 to 4 hours. Sodium chloride, although producing prodigious currents of Cl⁻, performed erratically and rarely gave more than 100 to 200 nA of Na⁻.

Molecular Ions

A typical negative ion spectrum obtained from a cathode containing sodium hydroxide mixed with silver powder is shown overleaf. Clearly evident in the spectrum are peaks corresponding to Na⁻, NaO⁻, NaOH⁻, and Na₂⁻. As with lithium the dimer is quite weak with about 2% the intensity of the elemental ion. From comparison with lithium it is expected that sodium should form single and double hydroxide negative ions but we have not observed these (the weak peak at mass 24 is thought to be ¹²C₂⁻). Interestingly, fairly prominent peaks were observed from a sodium chloride cathode corresponding to Na³⁵Cl⁻ and Na³⁷Cl⁻, the former with an intensity of about 1 μA.

A Negative Ion Cookbook

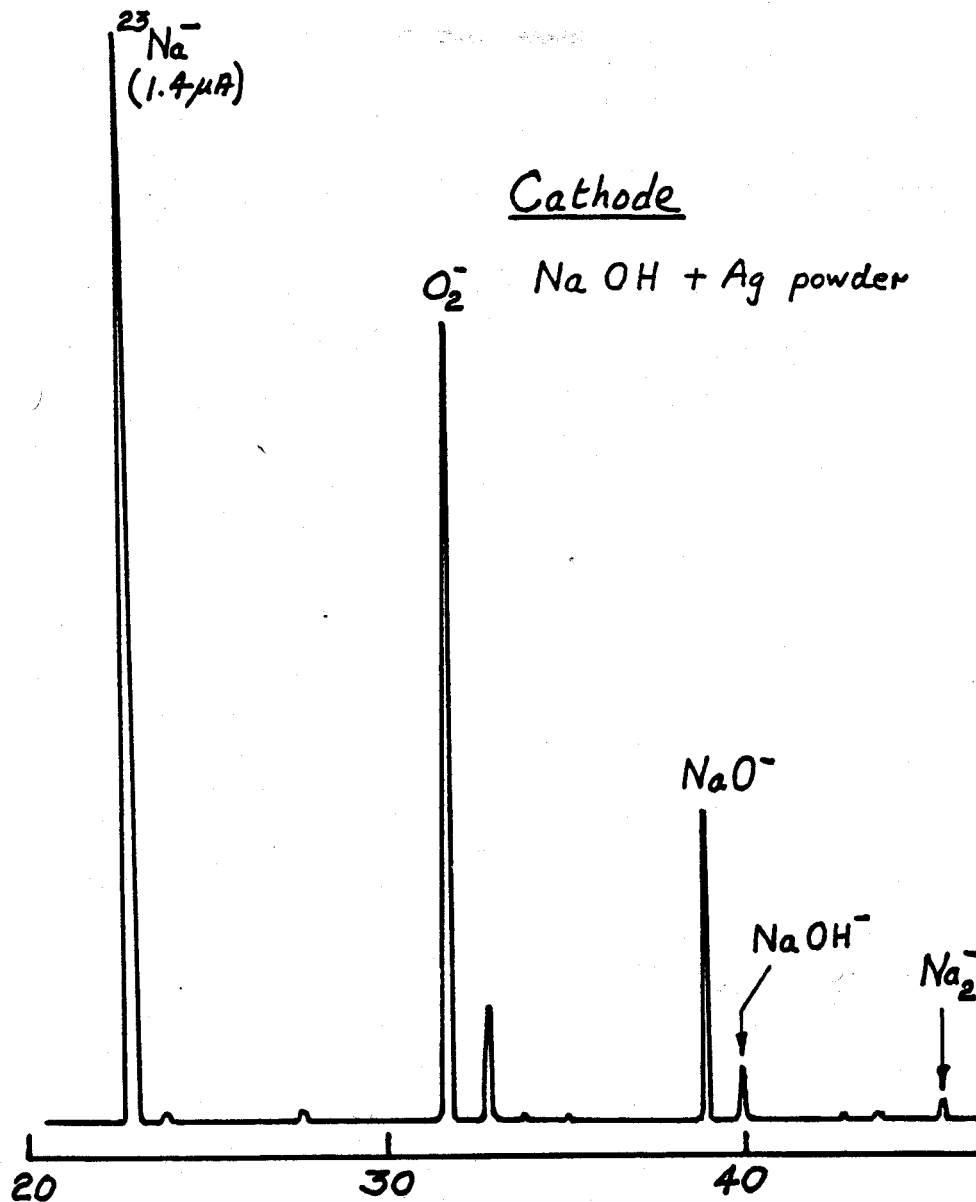

A negative ion spectrum obtained from a cathode loaded with a mixture of sodium hydroxide and silver powder. Immediately prior to loading the pellet of NaOH was heated to well past its melting point to drive off any water vapor. Note the weak peak corresponding to Na_2^- .

A Negative Ion Cookbook

¹²Magnesium

Isotopes

²⁴Mg - 78.99%, ²⁵Mg - 10.00%, ²⁶Mg - 11.01%

Physical Properties

E.A. < 0, I.P. = 7.64 eV, m.p. = 649 °C, W.F. = 3.66 eV

Cathodes

Since magnesium has a negative electron affinity and it does not form a metastable negative ion with a significant lifetime it is necessary to accelerate a molecule. Like the other alkaline earths, magnesium forms three negative hydrides and these are the molecules of choice. We have tried three different procedures to make these:

- 1) Magnesium gas cathode plus hydrogen or ammonia
- 2) A solid cathode loaded with commercially purchased magnesium hydride (MgH₂)
- 3) A solid cathode loaded with a mixture of titanium hydride (TiH₂) and magnesium powder.

Recommended Cathode

For currents greater than 1 or 2 μA a magnesium metal gas cathode, similar to that shown in the figure overleaf, should be used either with ammonia or hydrogen. Ammonia produces the largest currents and on occasions we have obtained 8 μA of ²⁴MgH⁻ and 10 μA of ²⁴MgH₃⁻; the dihydride is much weaker and usually partly obscured by CN. However, it may be more convenient to use hydrogen and with this we have obtained 1.5 μA of ²⁴MgH⁻ and 5 μA of ²⁴MgH₃⁻. Surprisingly the ratio of MgH₃⁻ to MgH⁻ is larger with the hydrogen than with ammonia (see the two spectra shown overleaf).

A more convenient approach is to use a solid cathode made from pressed magnesium hydride. We have been able to obtain 1 to 2 μA of ²⁴MgH (²⁴MgH⁻ currents are less) over periods of several hours using commercially purchased magnesium hydride. Unfortunately the currents are not reproducible and we think this is due to the instability of the hydride and its high reactivity with water vapor. It is also important to ensure that the cathode is well cooled since the hydride decomposes at about 280 °C. Our supplier of magnesium hydride has recently removed it from his catalog and we have been forced to attempt to make it ourselves. Although we have had excellent success in preparing hydrides of calcium, strontium and barium, we have had no success with magnesium.

An alternative and moderately successful approach that we have experimented with is to make cathodes out of a mixture of magnesium metal and titanium hydride powders. We find 1:1 by weight about an optimum mixture. Currents tend to rise slowly but after 30 minutes or so we usually obtain between 200 and 500 nA of ²⁴MgH⁻ ions. Interesting, the ²⁴MgH₃⁻ is extremely weak (see figure below).

A Negative Ion Cookbook

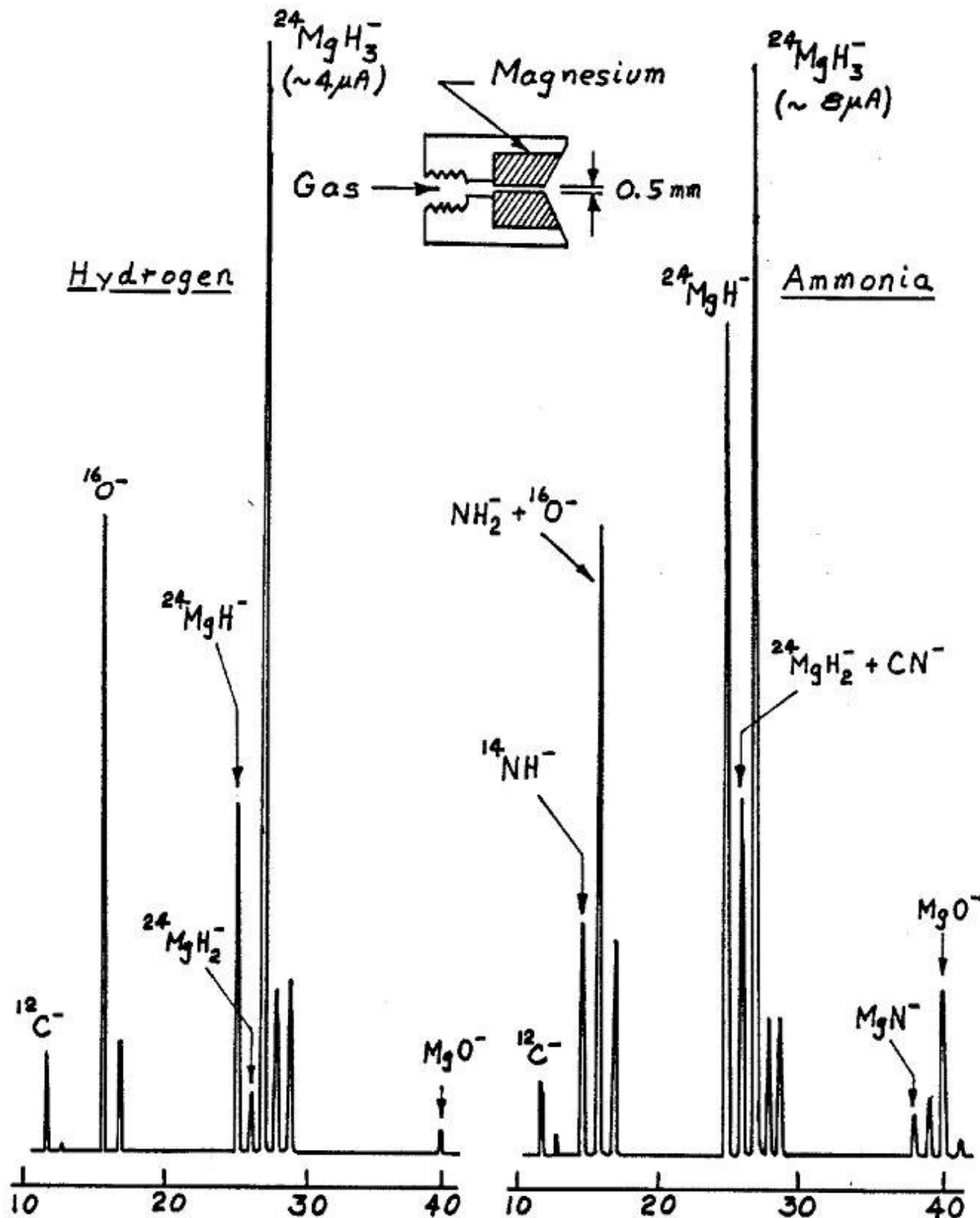

Spectra obtained with a magnesium gas cathode similar to that shown in the figure. The spectrum on the left was obtained with hydrogen and that on the right with ammonia and in both cases the partial pressure of the gas was about 1×10^{-6} Torr.

A Negative Ion Cookbook

Molecular Ions

Magnesium, like all of the alkaline earth metals, forms three negative ion hydrides, MgH^- , MgH_2^- , and MgH_3^- . Although the intensities of these can vary widely, the dihydride is invariably very weak. MgO^- is not a prolific negative but most spectra usually contain it. We observed $5 \mu\text{A}$ of MgO^- and about $0.4 \mu\text{A}$ of MgO_2^- ion from a magnesium oxide cathode that was yielding $380 \mu\text{A}$ of $^{16}\text{O}^-$. No systematic search has been made for other molecular ions but a peak was identified corresponding to MgN^- (and probably due to MgNH^-) in the spectrum from magnesium plus ammonia.

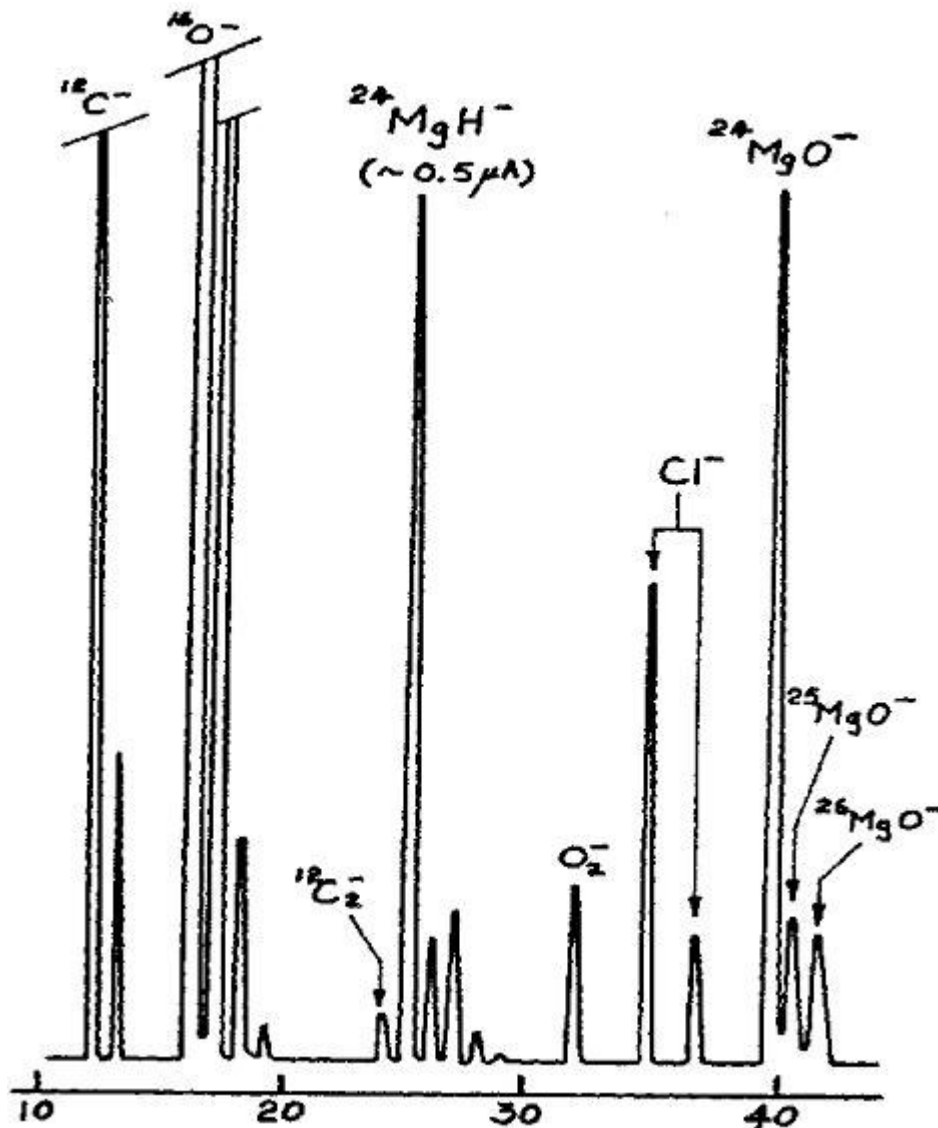

A spectrum obtained from a standard cathode containing a compressed mixture of magnesium and titanium hydride powders (about 1:1 by weight). Note the almost complete absence of MgH_3^- .

A Negative Ion Cookbook

TVDG Tandem Experience:

From an elemental cathode in the UNIS source, the single hydride will appear to be the larger beam of the two hydrides, but the triple hydride will grow to be the more intense molecular beam, by a factor of two or more. Raise the boiler until the thermocouple reads approximately 100 °C. Carefully add NH₃ gas until the base pressure in the NII increases slightly, and is stable. The triple hydride will rapidly become the obvious choice, with 10-20 nA observable in about 10-15 minutes. Use the triple hydride, MgH₃, and accelerate to 162.9 MeV using Q1=9, Q2=11. Be sure to set the Mass Out to 27 on the Tandem program.

Do not use 10-12. There will be an inseparable ¹²C beam from C₂.

For SEU work, the wall foil should be 600-700 ug/cm², 10nA on the LE cup will supply SEUTF with 1X10⁶ ions. The standard beam is 162 MeV, Q1=9, Q2=11. A Hard copy is in the Standard book. Set up parameters and notes are in the Tandem program.

An alternate beam is Q=11, single stripped to 170 MeV. It will deliver 4X10⁴ particles for 10 nA. It is NOT a standard beam however, and is only to be used if the highest possible energy is imperative. It will deliver the standard energy beam (162.9MeV) at a reduced terminal voltage of 13.69 MV.

A Negative Ion Cookbook

¹³Aluminum

Isotopes

²⁷Al - 100%

Physical Properties

E.A. = 0.441 eV, I.P. = 5.98 eV, m.p. = 660 °C, W.F. = 4.28 eV

Cathodes

Aluminum is far from a prolific negative ion, but nonetheless it is probably a better choice for acceleration in a tandem than more intense molecular ions. We have made measurements with three types of cathodes; aluminum metal, metal plus gas, and aluminum oxide (Al₂O₂) -- the latter as part of our ongoing AMS program of ²⁶Al studies.

Recommended Cathode

Aluminum metal is our first choice but it is important that it should be pure. Occasionally we have used an aluminum alloy and mistakenly identified ²⁸Si⁻ as ²⁷Al⁻. Alloys frequently contain 1 or 2% of silicon and since the latter is a very prolific negative ion the ²⁸Si⁻ current may exceed that of aluminum. We frequently prepare cathodes from commercially available high purity 1.6 mm diameter wire, intended for vacuum deposition. A short piece of the wire is hammered into a slightly larger diameter hole in a cathode and expanded to produce a tight fit. To accelerate the growth of the ²⁷Al⁻ current we usually drill a 0.5 mm diameter hole, 1 mm deep, into the aluminum.

Performance

Aluminum metal cathodes are notoriously slow risers and even when predrilled take about 1 hour to obtain a plateau of 6 to 8 μA. At this current cathode lifetime is only 3 or 4 hours. Aluminum oxide cathodes, which we normally use without silver powder, tend to perform erratically at first but after about 10 minutes settle down and usually provide a steady 0.5 μA of ²⁷Al⁻. This current slowly rises and after 30 to 40 minutes is usually between 1 and 2 μA. The yield of AlO⁻ is much larger and is often 20 to 40 μA accompanied by 4 to 6 μA of AlO₂⁻. The ionization efficiency of aluminum oxide, for producing ²⁷Al⁻ ions, has been measured and is about 0.2%. This implies that a typical cathode containing about 6 mg of oxide will produce about 2.5X10⁴ μC of ²⁷Al⁻ ions or an average current of about 2 μA for a little over 3 hours.

Molecular Ions

A characteristic of aluminum (metal cathode) is that it has several intense polyatomic negative ions and the dimer, Al₂⁻, is 6 to 8 times stronger than the elemental ion. While studying these, a weak but steadily growing peak was observed 2 mass units below Al₅⁻. There can be little doubt that this is ¹³³Cs⁻ and indeed most cathodes usually exhibit a similar weak peak. However, in this case the peak continued to grow, overtook the intensity of Al₅⁻, and after 45 minutes to an hour exceeded 1 μA. Additional emerging but weaker peaks were observed corresponding to AlCs⁻, Al₂Cs⁻, etc. -- see the spectrum overleaf. We have encountered only one other element that gives rise to an equally intense ¹³³Cs⁻ peak and this is iron -- see Cesium for further details.

During our study of the molecular ions we made some measurements with an aluminum metal gas cathode and hydrogen gas. As expected from a previous study¹, even at low partial hydrogen pressure a weak peak was observed corresponding to AlH⁻ and a much stronger peak of AlH₂⁻. To our surprise, as the hydrogen pressure was increased, a peak emerged corresponding to AlH₄⁻ which at 2X10⁻⁶ Torr rivaled the intensity of AlH₂⁻ (~2.5 μA). A very weak peak corresponding to AlH₃⁻ was also observed (see spectra overleaf). Although many heavier elements and particularly the rare earths form intense tetra-hydride negative ions, it is unusual for a light element.

A Negative Ion Cookbook

Reference

1. R. Middleton, Nucl. Instr. & Methods 144 (1977) 373.

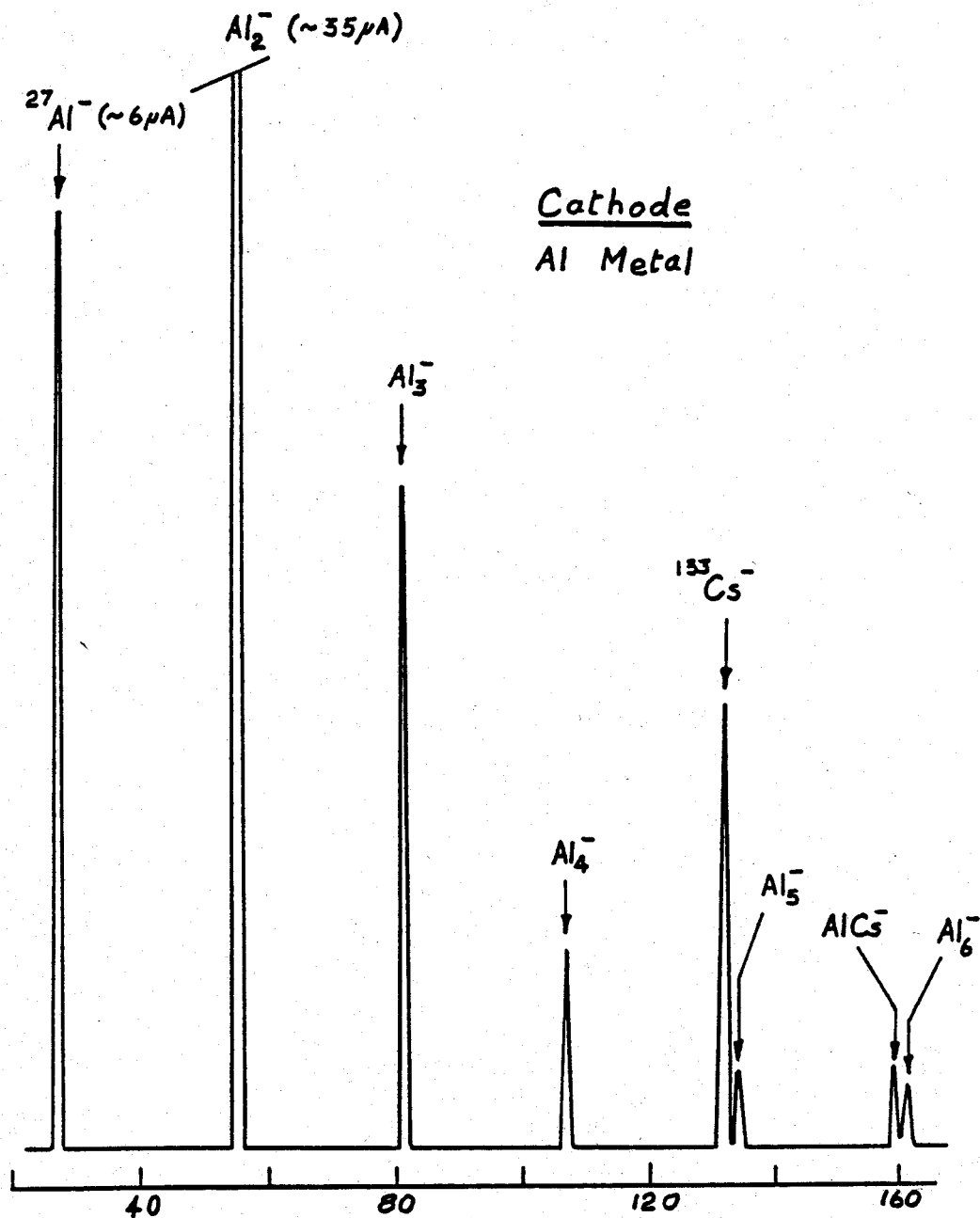

A negative ion spectrum obtained from an aluminum metal cathode in a high intensity source fitted with a spherical ionizer. Note the large number of polyatomic negative ions, the unusually strong dimer ($\sim 40\mu\text{A}$) and the intense peak ($\sim 2\mu\text{A}$) of $^{133}\text{Cs}^-$. We suspect that the latter ion is formed in the intense plasma at the bottom of a steep narrow sputter crater produced by the extremely tightly focussed Cs^+ beam. An equally strong $^{133}\text{Cs}^-$ beam has only previously been observed from an iron cathode - see Cesium.

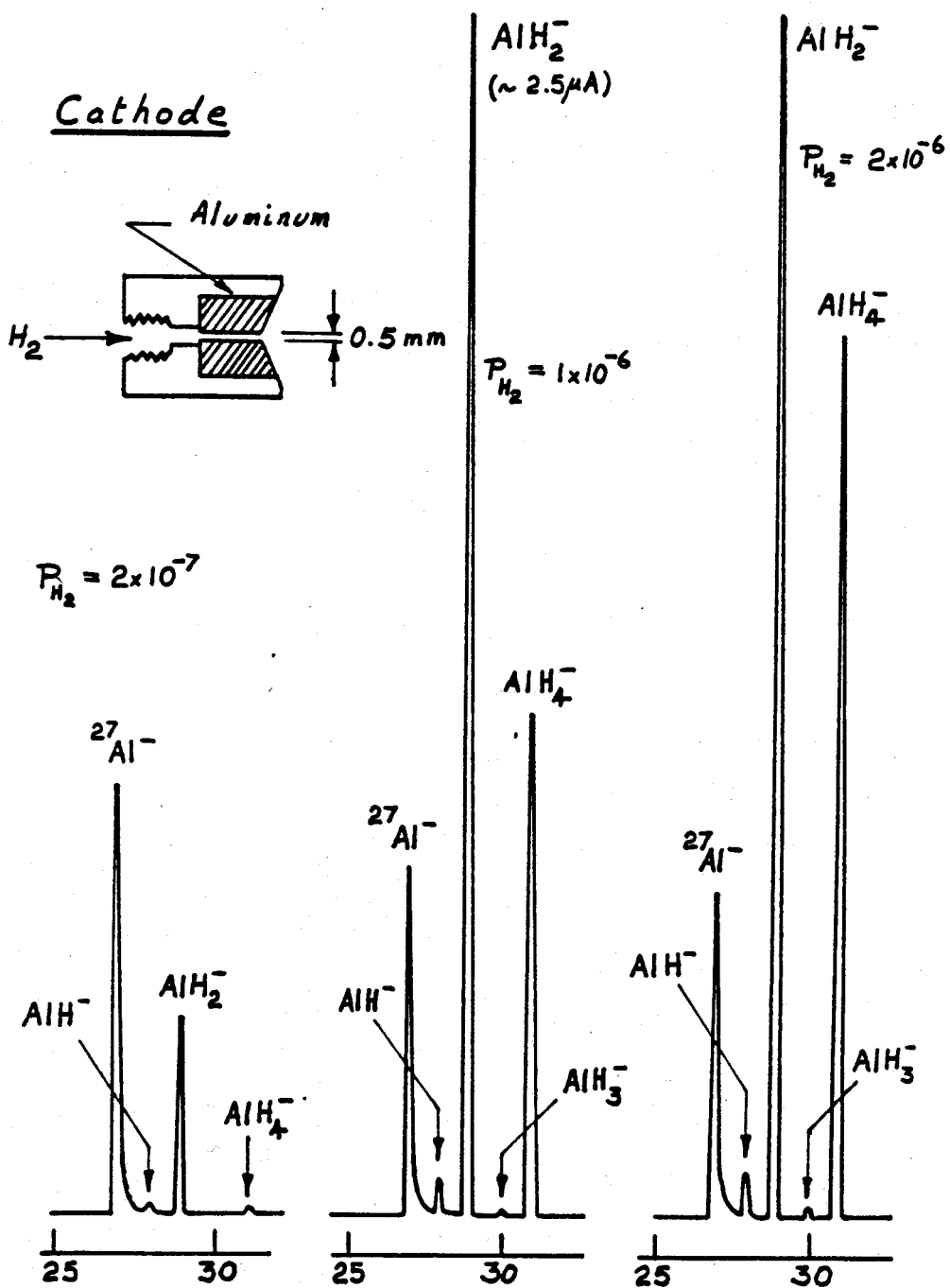

The left hand spectrum was obtained using the cathode shown in the sketch and a very little amount of hydrogen (a partial pressure of 2×10^{-7} Torr). The middle and right hand spectra were obtained with progressively increased hydrogen flow. Particularly surprising was the emergence of a strong ($\sim 2 \mu A$) peak of AlH_4^- and the very weak AlH_3^- peak.

A Negative Ion Cookbook

¹⁴Silicon

Isotopes

²⁸Si - 92.23%, ²⁹Si - 4.67 %, ³⁰Si -3.10%

Physical Properties

E.A. = 1.385 eV, I.P. = 8.15 eV, m.p. = 1410 °C, W.F. = 4.85 eV

Cathodes

Since silicon is a very prolific negative ion and usually produces currents larger than needed, we have not tried many kinds of cathodes and usually make ours from elemental metal.

Recommended Cathode

Cathodes made from a single piece of silicon crystal perform superbly and last for many hours. We usually core a 5 or 6 mm diameter piece from 3 mm thick crystal and then carefully press it into a pre-drilled hole in a copper cathode. Needless to say, mounting is tricky, particularly without breaking and while achieving good thermal contact with the copper.

A simpler procedure for producing cathodes that perform almost as well is to hammer commercially available silicon powder into a 1.6 mm diameter hole in a standard cathode. The powder packs well and there is no need to add silver powder. Alternatively, scrap pieces of silicon crystal crush remarkably easily and can be packed directly into a cathode -- we particularly like this last method.

Performance

The ²⁸Si⁻ current from powder cathodes rises quickly, within 15 minutes is usually over 100 μA and within an hour is at least 200 μA. With currents this large it usually is unnecessary to use separated isotopes to obtain microampere beams of ²⁹Si⁻ and ³⁰Si⁻.

Molecular Ions

Like carbon, silicon forms fairly intense beams of polyatomic negative ions (see spectrum overleaf). The relative strengths of these are somewhat variable and depend upon the nature of the cathode and on the cathode voltage, but on one occasion the ratio of Si⁻ : Si₂⁻ : Si₃⁻ : Si₄⁻ was 100 : 27 : 2.6 : 0.4. Since most of our cathodes were made from high purity silicon we have observed few molecular ions and have no evidence for the existence of negative hydrides and oxides. Indeed, the only molecular ions that we have consistently observed are ⁶³Cu²⁸Si⁻ and ⁶⁵Cu²⁸Si⁻, the intensity of the former frequently exceeding 1 μA.

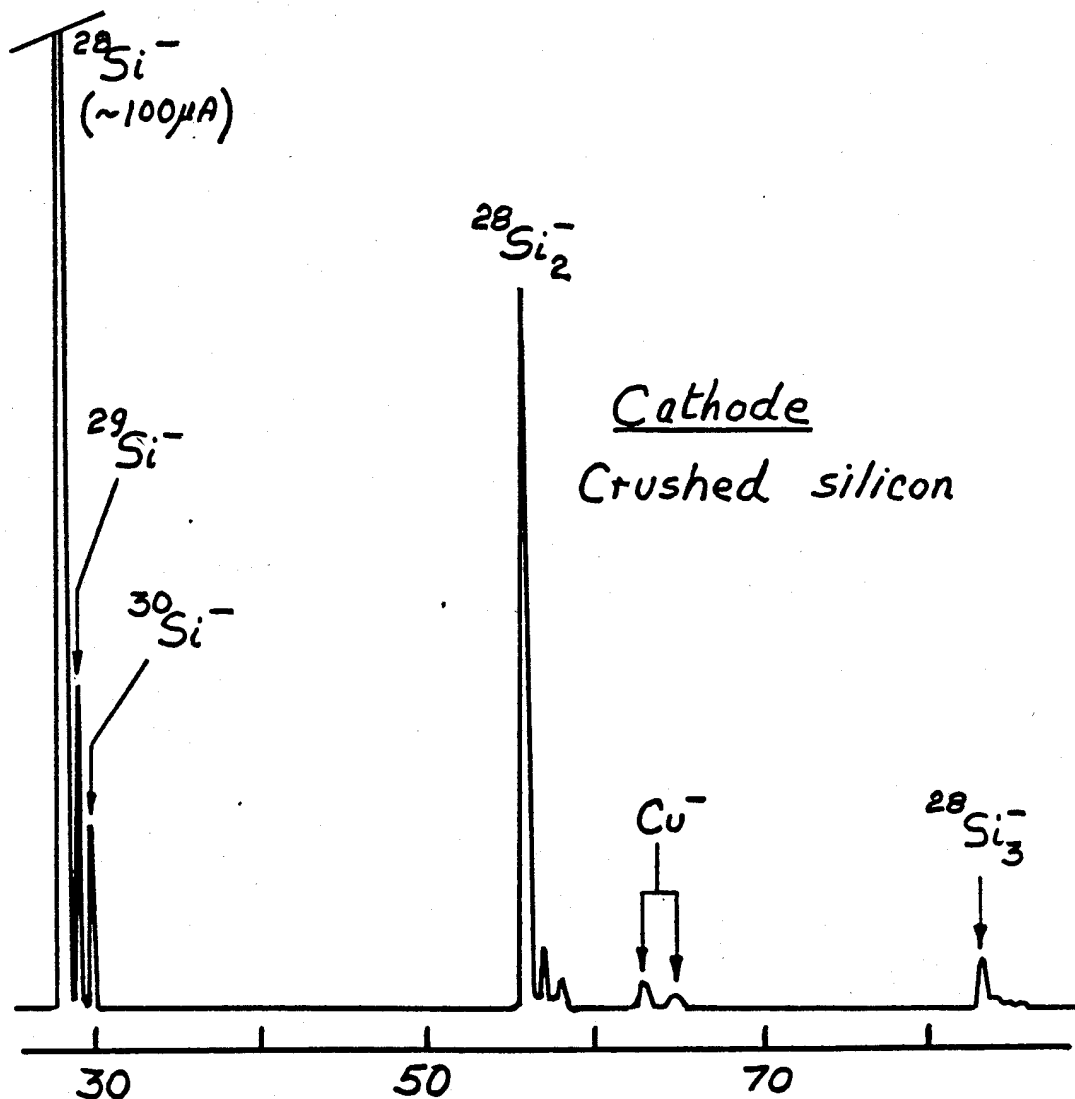

Showing the particularly clean negative ion spectrum observed from a cathode containing ultra-pure silicon crystal. This cathode was prepared by crushing leftover scraps of silicon crystal and hammering them into a 1.6 mm diameter hole, 3 mm deep, in a copper cathode. Silicon, like carbon, has several intense polyatomic negative ions.

A Negative Ion Cookbook

¹⁵Phosphorus

Isotopes

³¹P - 100%

Physical Properties

E.A. = 0.747 eV, I.P. = 10.48 eV, m.p. = 44 °C

Cathodes

Owing to its low melting point and high vapor pressure we have never used the element in a cathode. Rather we have tried several metallic phosphides including iron phosphide (TiP). All ran well and produce stable and intense ³¹P⁻ beams.

Recommended Cathode

Iron phosphide performed exceptionally well. It is easy to load, runs very stably, and produces currents ranging from 40 to 70 μA. Cathode lifetime is also good and is typically 3 to 5 hours. Gallium phosphide performed almost as well. Overleaf are shown negative ion spectra from iron and gallium phosphides.

Molecular Ions

The polyatomic negative ions of phosphorus are weak and the dimmer (P₂⁻) has about 2 or 3% the intensity of the elemental ion -- the trimmer (P₃⁻) is even weaker. We have no evidence for the existence of a hydride and the weak peak that we frequently observe at mass 32 (iron phosphide spectrum overleaf) is probably O₂⁻. Phosphorus has at least three negative oxide ions, PO⁻, PO₂⁻, and PO₃⁻, and all are evident in the iron phosphide spectrum. The metallic phosphide ion is usually quite intense and in the case of iron phosphide was between 3 and 6 μA -- about 10% of the elemental current.

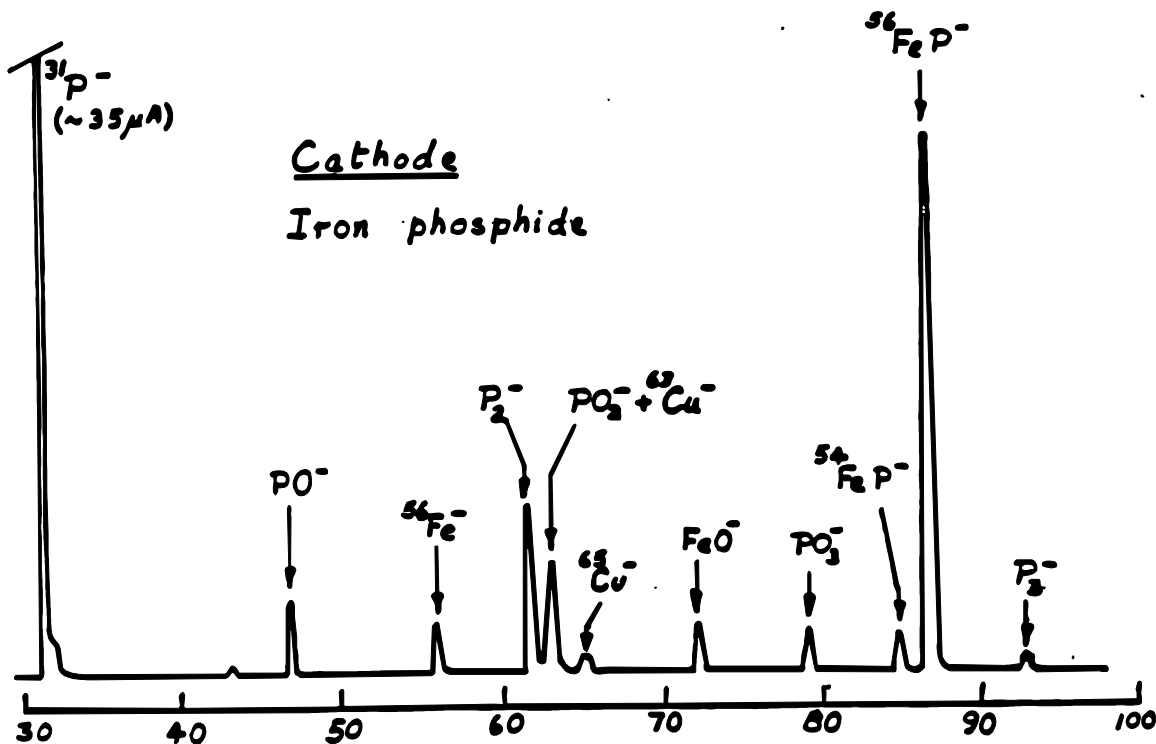
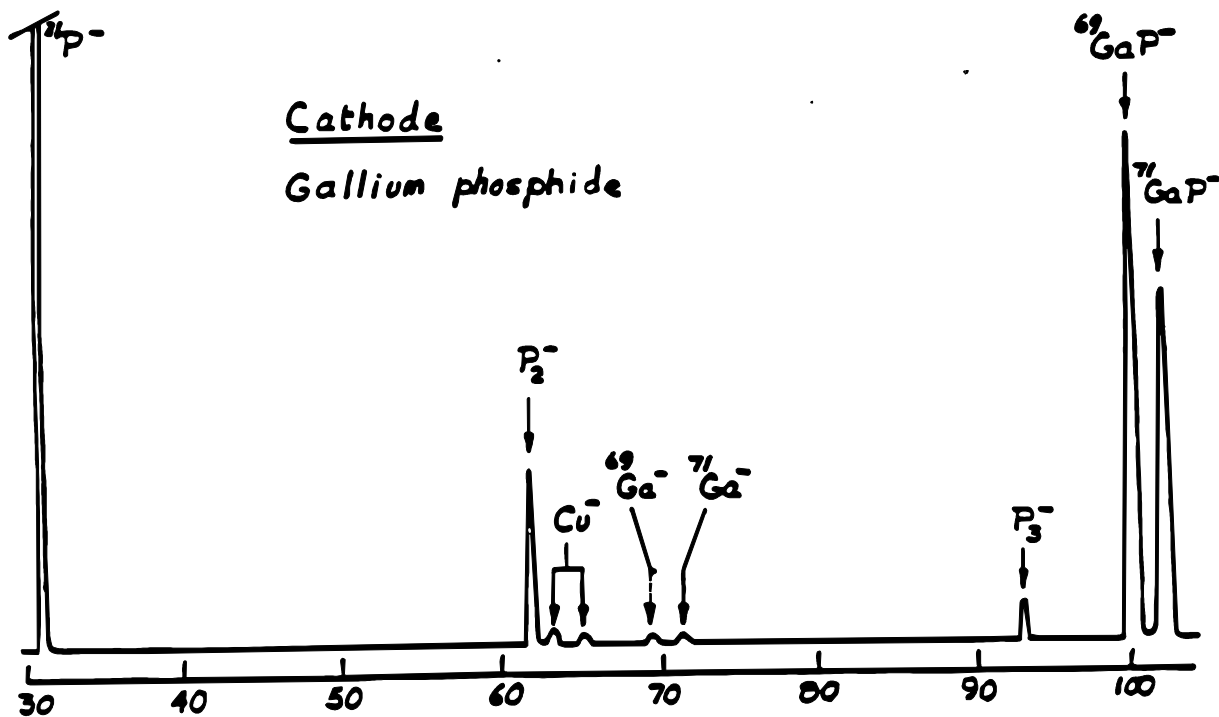

Showing negative ion spectra obtained from cathodes containing gallium phosphide (upper figure) and iron phosphide (low spectrum). Both cathode materials produced elemental currents between 25 and 75 μA and generally performed well.

A Negative Ion Cookbook

¹⁶Sulfur

Isotopes

³²S - 95.02%, ³³S - 0.75%, ³⁴S - 4.21%, ³⁶S - 0.02%

Physical Properties

E.A. = 2.077 eV, I.P. = 10.36 eV, m.p. = 113 °C

Cathodes

Owing to its low melting point and extremely high vapor pressure elemental sulfur is unsuitable and we have used a metallic sulfide, such as lead sulfide (PbS, m.p. 1114 °C). Recently we had occasion to use iron sulfide (FeS, m.p. 1195 °C) and found it slightly better. We have been told that lithium sulfide (Li₂S, m.p. > 900 °C) is even better but we have not tried it.

Recommended Cathode

Since sulfur is such a prolific negative ion we suspect that almost any metallic sulfide will perform satisfactorily. Our recent experience with iron sulfide was good. It packs easily and well in a cathode, the negative current rises quickly and is very steady -- typical currents were in the range 100 to 250 μA.

Molecular Ions

Sulfur forms polyatomic negative ions and the dimer (S₂⁻) is usually about 1 to 2% the strength of the elemental ion. We think we have observed the trimer (S₃⁻) but it is very weak. We have never observed any hydrides; owing to the presence of isotopes these would be difficult to detect, but it is likely that they exist. Sulfur does not form strong oxide ions but we usually observe a weak peak at mass 48 from lead sulfide cathodes that we think corresponds to SO⁻.

As might be expected, most metallic sulfide cathodes produce negative ion beams of the metal sulfide and the di-sulfide. For example, iron sulfide usually gives about 4 or 5 μA of FeS⁻ ions and about 0.5 μA of FeS₂⁻. Lead sulfide behaves similarly but producing slightly weaker beams.

Isotopic Beams

Usually 2 or 3 μA of ³⁴S⁻ ions can be obtained from a cathode containing natural sulfur and with care about 1 μA of ³³S⁻. To obtain comparable currents of ³⁶S⁻ requires enriched material. Recently we obtained between 1 and 2 μA of ³⁶S⁻ ions from an iron sulfide cathode prepared from sulfur enriched to about 90% in ³⁴S (Note, not all enriched ³⁴S is necessarily enriched in ³⁶S). The enriched sulfur, which was purchased in elemental form, was converted to iron sulfide by mixing with iron powder (1:1 by atom) and then heating the mixture to about 300 °C, under argon in a quartz test tube. The reaction is exothermic and its occurrence is characterized by a distinct red glow. Overleaf is shown a negative ion spectrum obtained from this material.

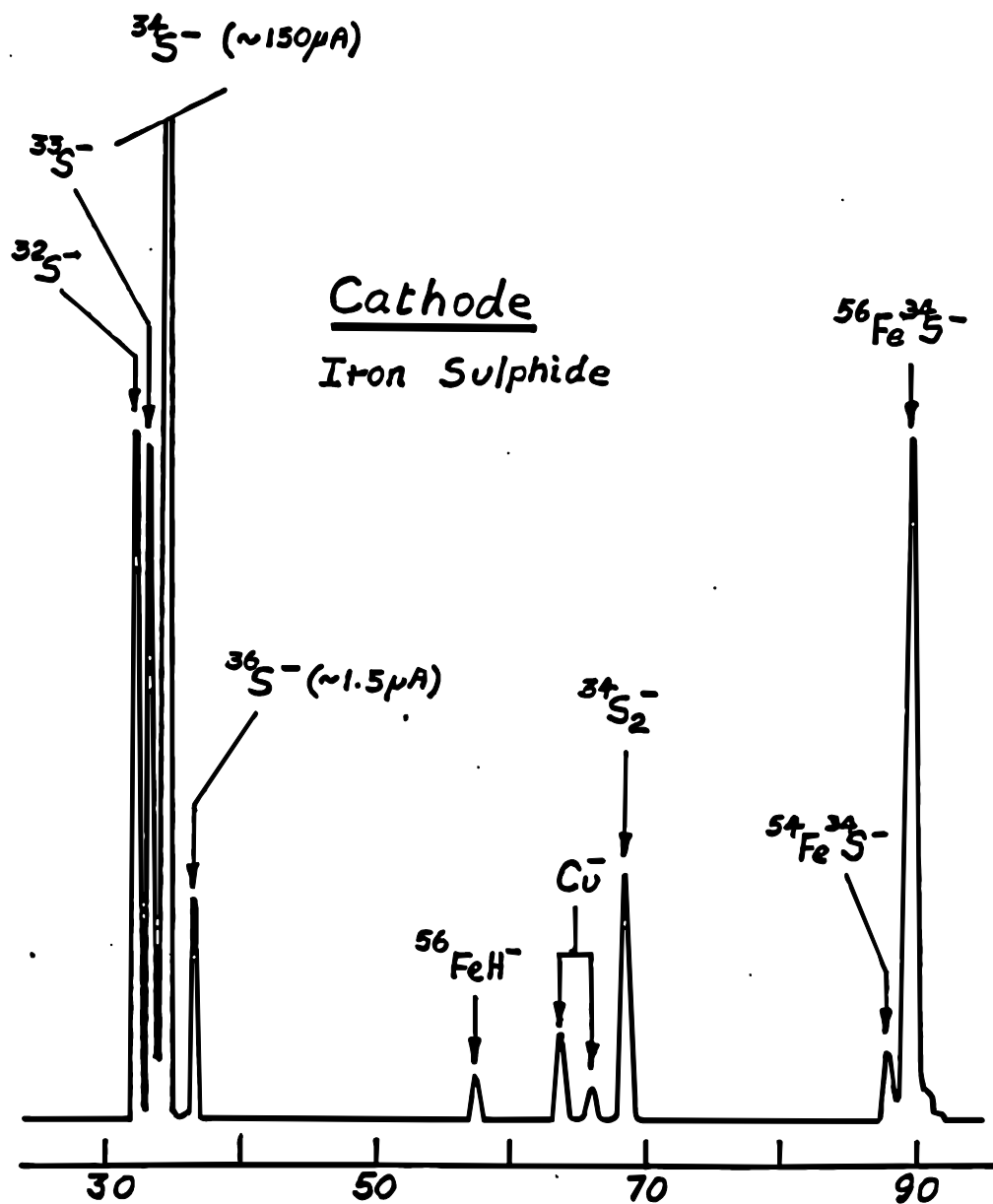

A negative ion spectrum obtained from a cathode containing iron sulfide (FeS) enriched to about 90% in ^{34}S . The cathode was used as a source of $^{36}\text{S}^-$ ions, providing between 1 and 2 μA . Note the presence of the dimer ($^{34}\text{S}_2^-$) and 4 or 5 μA of $^{56}\text{Fe}^{34}\text{S}^-$ ions.

A Negative Ion Cookbook

17Chlorine

Isotopes

^{35}Cl - 75.5%, ^{37}Cl - 24.5%

Physical Properties

E.A. = 3.617 eV, I.P. = 13.01 eV, m.p. – gas

Cathodes

Like fluorine, chlorine is a very prolific negative ion and almost any chloride is likely to produce large currents. We have made measurements with crushed halite (NaCl, m.p. 801 °C), potassium chloride (KCl, m.p. 722 °C), and silver chloride (AgCl, m.p. 455 °C). The former two compounds produced large currents but even when mixed with silver powder they performed erratically and were generally unsatisfactory.

Recommended Cathode

Silver chloride performs excellently. It packs well in a cathode, produces large currents (100 to 300 μA of $^{35}\text{Cl}^-$) and runs reasonably steadily. We usually run with a reduced cesium reservoir temperature and often at lower cathode voltage, and even then the current is usually at least 100 μA . One such cathode, containing 19 mg of AgCl, produced 6×10^5 μC of $^{35}\text{Cl}^-$ ions, corresponding to an ionization efficiency of 16% -- the highest we have measured.

Molecular Ions

Chlorine forms few molecular ions and the only polyatomic negative ion that we have observed is the dimer, Cl_2^- . Usually this is weak and typically about 0.3% the intensity of the elemental ion -- see spectrum overleaf. We have never observed a hydride and Kilius *et al.*¹⁾ report the intensity of H^{35}Cl^- relative to $^{35}\text{Cl}^-$ to be less than 1.3×10^{-14} . Usually cathodes containing a metallic chloride produce a metal-chloride negative ion. For example we usually observe weak beams corresponding to AgCl^- ions from silver chloride cathodes and often peaks corresponding to CuCl^- . Sodium chloride frequently gives rise to $^{22}\text{Na}^{35}\text{Cl}^-$ currents exceeding 1 μA .

Reference

- 1) L.R. Kilius, M.J. Nadeau, J.C. Rucklidge, and A.E. Litherland, Nucl. Instr. and Methods B29 (1987) 57.

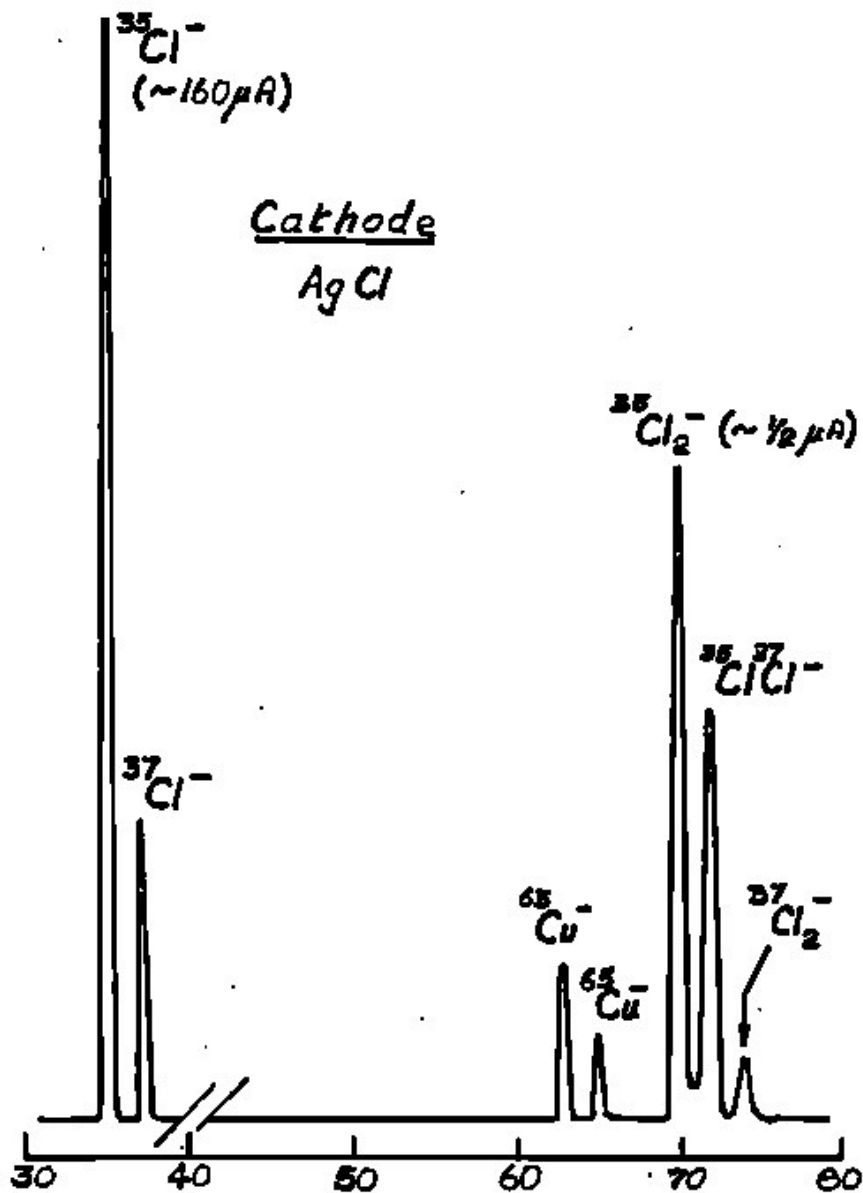

Part of a negative ion spectrum from a cathode containing silver chloride. Cathodes such as this frequently produce 300 and 400 μA of $^{36}\text{Cl}^-$ and we usually find it expeditious to reduce the cesium reservoir temperature and the cathode voltage. Note the weak peaks corresponding to the chlorine dimers.

A Negative Ion Cookbook

¹⁸Argon

Isotopes

³⁶Ar 0.34%, ³⁸Ar - 0.06%, ⁴⁰Ar - 99.6%

Physical Properties

E.A. < 0, I.P. = 15.76 eV, m.p. -189 °C

Cathodes

To the best of our knowledge, argon has a negative electron affinity, does not form a metastable negative ion, and no molecular ions have been observed.

A Negative Ion Cookbook

¹⁹Potassium

Isotopes

³⁹K - 93.26%, ⁴⁰K - 0.01% ($T_{1/2} = 1.3 \times 10^9$ yrs.), ⁴¹K - 6.73%

Physical Properties

E.A. = 0.501 eV, I.P. = 4.34 eV, m.p. = 63.7 °C, W.F. = 1.30 eV

Cathodes

Since potassium has a low melting point and is a reactive metal, we never attempted to use it in a cathode. Rather we have used compounds including potassium super oxide (K_2O , m.p. 380 °C), potassium hydroxide (KOH, m.p. 360 °C), potassium carbonate (K_2CO_3 , m.p. ~91 °C), potassium chloride (KCl, m.p. 770 °C), and potassium bromide (KBr, m.p. 734 °C). The first three performed best but ran erratically and produced relatively low currents ranging from 0.3 to 0.8 μA . Addition of silver powder improves stability but lessens the current. Also, all are hygroscopic and ideally should be loaded in a dry box. The two halogen compounds, as might be expected, produced large halogen currents, but the ³⁹K⁻ yield was disappointing and usually < 100 nA.

Recommended Cathode

Potassium hydroxide and carbonate both performed well but the carbonate seemed more predictable, less hygroscopic and easier to handle and is our choice. We usually melt a small amount of it on a heavy metal block causing it to ball and bubble. When bubbling has stopped, the ball is allowed to cool and is immediately crushed and pressed into a cathode and introduced into the source. Mixing with silver powder improves stability but lessens the current and we don't recommend it. Overleaf is shown a typical negative ion spectrum from a cathode prepared in this way. We draw attention to the peaks corresponding to CO_2^- and CO_3^- , indicating that the carbonate did not decompose (we thought it might during heating) and the absence of a CO^- peak (is this an unstable negative ion?).

Performance

Potassium carbonate cathodes prepared without silver tend to outgas heavily and we recommend that the cathode voltage be slowly increased over the first 10 minutes. Maximum current usually occurs after about 30 minutes and never completely stabilizes. Cathode lifetime is surprisingly good and even after 3 or 4 hours we have never completely exhausted a cathode.

Molecular Ions

We have never unambiguously and positively established the existence of a dimer or a hydride negative ion, but from comparison with lithium and sodium we believe they must exist. Indeed the only molecular ions that we have observed with certainty are ³⁹KO⁻ and ³⁹KO₂⁻, see spectrum overleaf.

A Negative Ion Cookbook

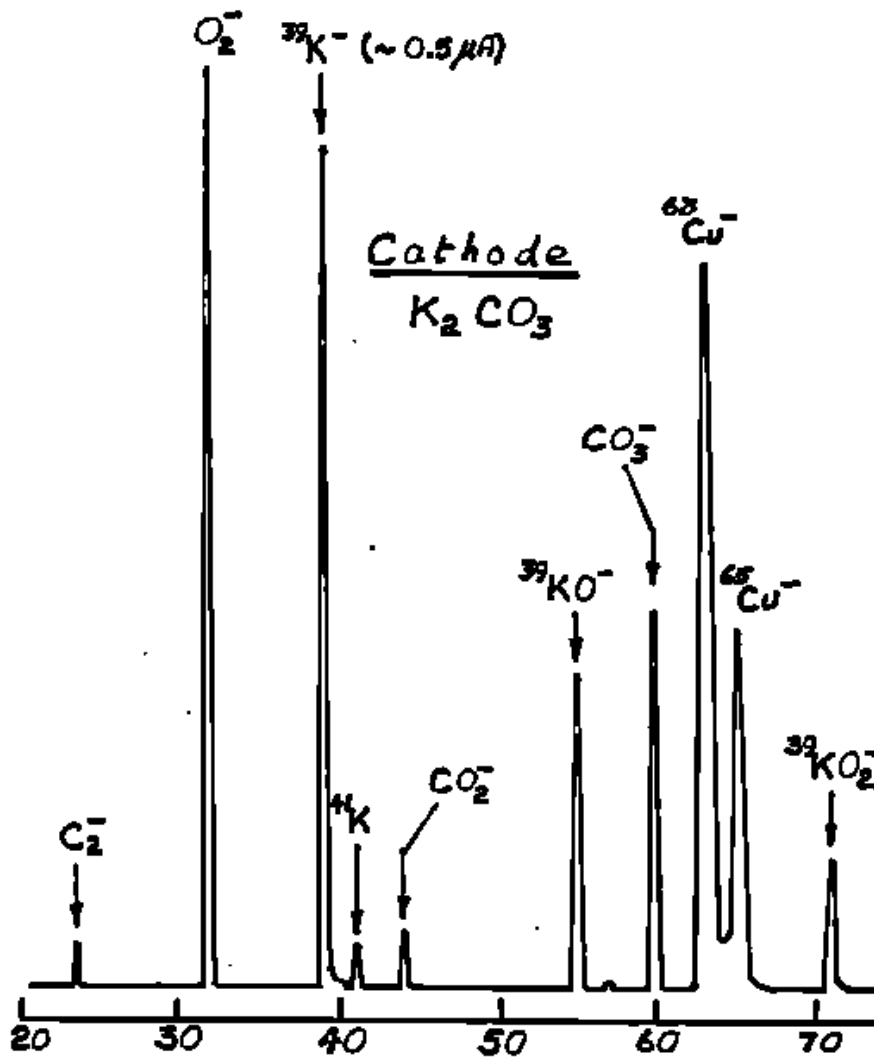

A negative ion spectrum obtained with a cathode loaded with dried potassium carbonate. Although addition of silver powder improves stability it reduces the current and we prefer not to use it. Note the peaks (from the carbonate) corresponding to CO_2^- and CO_3^- and the lack of a peak from CO^- .

A Negative Ion Cookbook

²⁰Calcium

Isotopes

⁴⁰Ca - 96.94%, ⁴²Ca - 0.647%, ⁴³Ca - 0.135%, ⁴⁴Ca - 2.086%, ⁴⁶Ca - 0.004%, ⁴⁸Ca - 0.187%

Physical Properties

E.A. = 0.043 eV, I.P. = 6.11 eV, m.p. = 843 °C, W.F. = 2.87 eV

Cathodes

Calcium is an unusually important negative ion, in part due to the role of ⁴¹Ca in accelerator mass spectrometry (AMS) and the value of ⁴⁸Ca as a nuclear projectile. Consequently we have devoted considerable time to exploring ways and means of efficiently producing various molecular beams.

AMS requirements are largely dictated by the need to choose a negative ion that minimizes the effect of the ⁴¹K isobar. In this regard CaH₃⁻ is an excellent choice since KH₃⁻ is an unstable negative ion. We have shown that intense (5 to 10 μA) beams of CaH₃⁻ are best made from calcium hydride and have developed the techniques for preparing the compound from small samples of calcium oxide. These are described at the end of this section on Calcium. We have also shown that weak beams of CaH₃⁻ (and also CaH⁻) can be made from a mixture of calcium oxide and titanium or zirconium hydride. Finally we have explored the similarity between hydrides and fluorides and have shown that CaF₃⁻, like CaH₃⁻, does not have a stable potassium counterpart. Needless to say, many of the techniques developed for ⁴¹Ca find direct application in the acceleration of ⁴⁸Ca.

Since the electron affinity of calcium is very small it is all but impossible to make the elemental negative ion in a sputter source. The preferred molecular ion is the hydride and like magnesium it forms three; CaH⁻, CaH₂⁻, and CaH₃⁻, with the dihydride usually weak. These are best made from a solid cathode containing calcium hydride (CaH₂) or from a gas cathode containing metallic calcium and using ammonia gas.

We have also made measurements with cathodes containing calcium carbide (CaC₂), calcium oxide (CaO), and calcium fluoride (CaF₂). The intensities of the molecular ions from these are disappointing, rarely exceeding 1 μA compared with 5 μA or more of CaH₃⁻.

Recommended Cathode

For natural calcium, commercially available calcium hydride (CaH₂, decomposes in vacuum ~ 400 °C) is an excellent cathode material, provided it is kept dry (it is very hygroscopic). We usually buy it in 5 or 6 mm sized chunks and keep it stored in a dry box. When we wish to make cathodes a single piece is removed and broken into smaller pieces, providing enough material to load 4 or 5 cathodes. Immediately a cathode is loaded it is placed in a glass ampoule, evacuated and sealed. Cathodes stored this way last indefinitely. We have never found it necessary to mix calcium hydride with silver powder and generally advise against it.

The isotopes of calcium are usually available in carbonate form and can be converted to oxide by heating in air at 850 to 900 °C. In oxide form they can either be converted into calcium hydride, following the two-step procedure described below, or used directly in the ion source. Calcium

A Negative Ion Cookbook

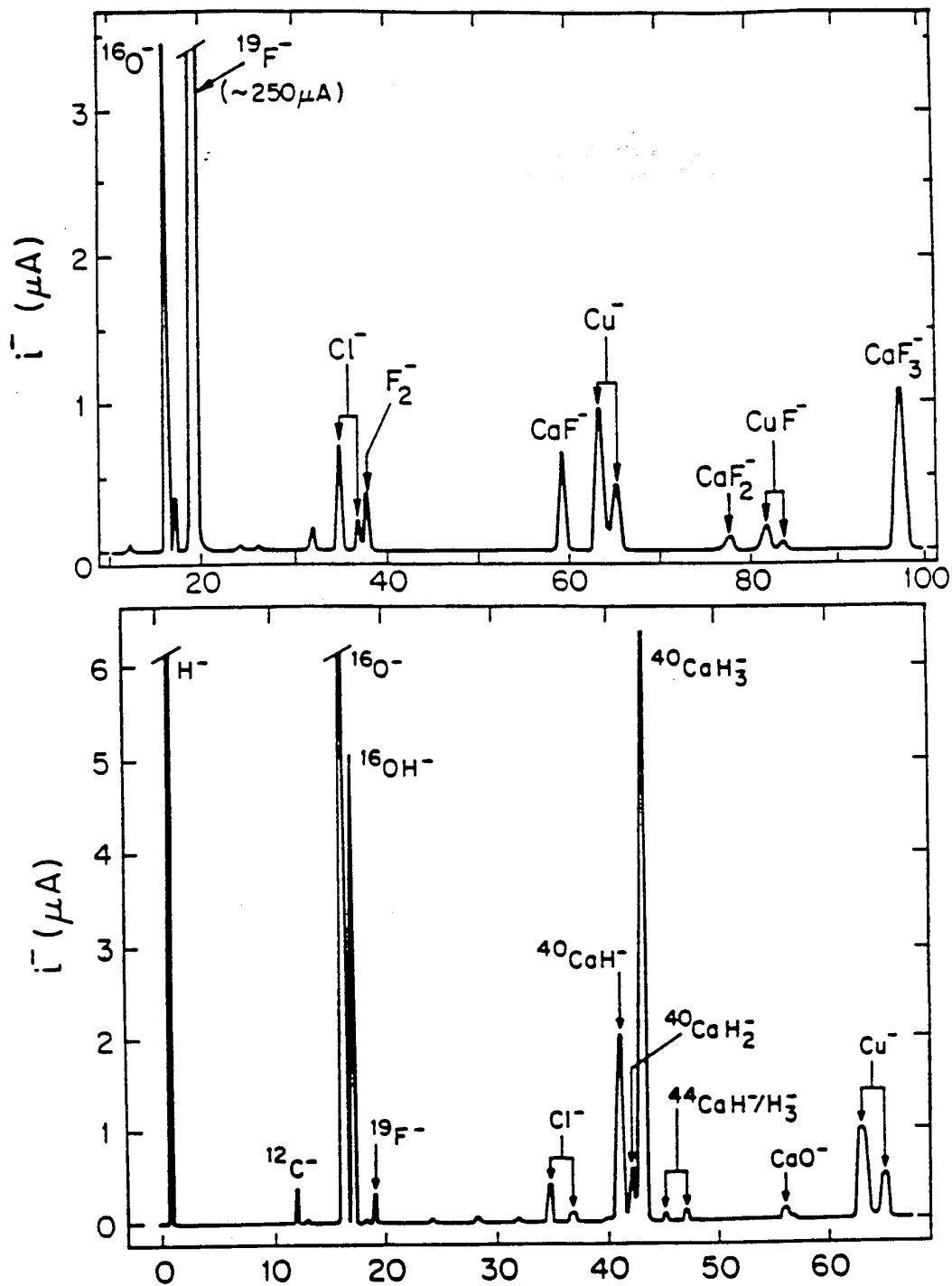

Negative ion spectra obtained with cathodes containing calcium fluoride (upper) and calcium hydride (lower). Note the general similarities- each contains three molecular ions and in both cases the trimer is the strongest and the dimer is the weakest.

A Negative Ion Cookbook

oxide is not a particularly good cathode material but usually produces about 1 μA of CaO^- ions. If energy is not an important consideration this might well be a reasonable way of proceeding. However, if energy is more important than current, another option is to mix the CaO with TiH_2 (about 1:10 by weight). Cathodes prepared from this mixture usually produce 80 to 150 nA of CaH^- ions (and considerably less of CaH_3^-). It is noteworthy that if ^{48}Ca is to be accelerated, titanium hydride should be replaced with zirconium hydride to avoid interference from $^{48}\text{TiH}^-$, a fairly prolific ion.

Performance

Provided calcium hydride cathodes have not “spoiled” from exposure to water vapor, they perform well but frequently take 30 to 40 minutes to attain maximum current. A typical negative ion spectrum is shown on the facing page (lower figure). It may be noted that the CaH_3^- current is usually about three times that of CaH^- and the CaH_2^- current is almost negligible. Curiously, with calcium deuteride, the CaD_3^- current is only about 1.5 times that of CaD^- . Cathode lifetime is fairly good and one cathode containing 6.8 mg of calcium hydride produced $3 \times 10^4 \mu\text{C}$ of $^{40}\text{CaH}_3^-$ ions, corresponding to an ionization efficiency of 0.2%.

Calcium hydride negative ions, like those of magnesium, can also be made with a metal-gas cathode and ammonia. With relatively low gas consumption we have obtained 8 μA of CaH^- and 4 μA of CaH_3^- -- note, in this case, the single hydride ion is larger than the triple hydride.

Molecular Ions

The most prolific calcium molecular ions are the hydrides, CaH^- , CaH_2^- , and CaH_3^- . The carbides are weak and the largest CaC^- current we obtained from a calcium carbide cathode was 0.2 μA . Likewise the oxides are not particularly strong and we have rarely observed more than 1 μA of CaO^- ions from an oxide cathode. We have made extensive measurements with calcium fluoride cathodes and the upper figure on the facing page shows a typical spectrum, Note the similarities between the hydride and fluoride spectra and that the overall intensity of the fluorides is less than that of the hydrides.

Calcium Hydride Production

Calcium hydride is produced by a two-step process, the first involving the reduction of calcium oxide to calcium metal, and the second the conversion of the metal to hydride. The oxide is reduced by heating a mixture containing an excess of zirconium powder according to the reaction:

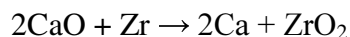

We usually thoroughly mix, using a mortar and pestle, Zr and CaO in the proportions 3:1 by weight. The mixture is poured into the 6 mm diameter by 20 mm long tantalum crucible shown in the upper figure, facing page, and then thoroughly tamped down. Before attaching the tight-fitting lid a small ball of crinkled tantalum mesh is pressed into the crucible above the Zr - CaO mixture.

The reduction requires a temperature of about 1500 $^\circ\text{C}$ and after much experimentation with resistive heating we finally adopted the electron bombardment system shown in the upper figure. This has two important advantages: 1) the heating is efficient and the necessary high temperature can easily be achieved, 2) it permits the crucible to have a thick (~3mm) lid containing a 0.7 mm diameter exit hole. The latter is particularly important since it collimates the effusing calcium vapor and causes it to condense on the cooled copper catcher as a “chunk”, greatly facilitating the conversion to hydride. It is important that the reduction is carried out in a good vacuum and after an initial outgassing we wait for a vacuum of 2×10^{-6} Torr.

A Negative Ion Cookbook

The condensed calcium doesn't adhere too well to the catcher and can usually be flicked off with a scalpel as a single piece. Without delay the piece is placed inside a short length of Vycor tubing, held central by two loose-fitting Pyrex wool plugs, and the tube is slipped inside a coil of coaxial heating wire (lower figure facing page). The system is evacuated, purged once with hydrogen, and then back-filled to a pressure of 600 Torr. The temperature of the heater is slowly increased, and usually when it is glowing feebly a wave of color sweeps through the calcium, indicating successful exothermic absorption. The calcium hydride is next loaded as quickly as possible into cathodes and the latter are sealed off in individually evacuated glass ampoules.

Both steps of the process are efficient and we rarely lose more than 10% of the initial calcium. With care, a 25 mg load of CaO provides enough hydride to load two cathodes.

BNL TVDG Experience:

Less gas favors CaH and more gas favors CaH₃.

A Negative Ion Cookbook

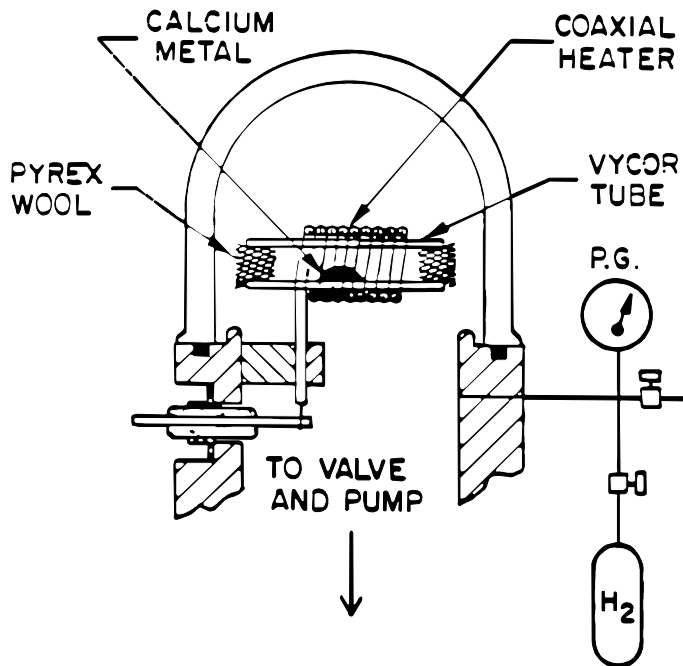
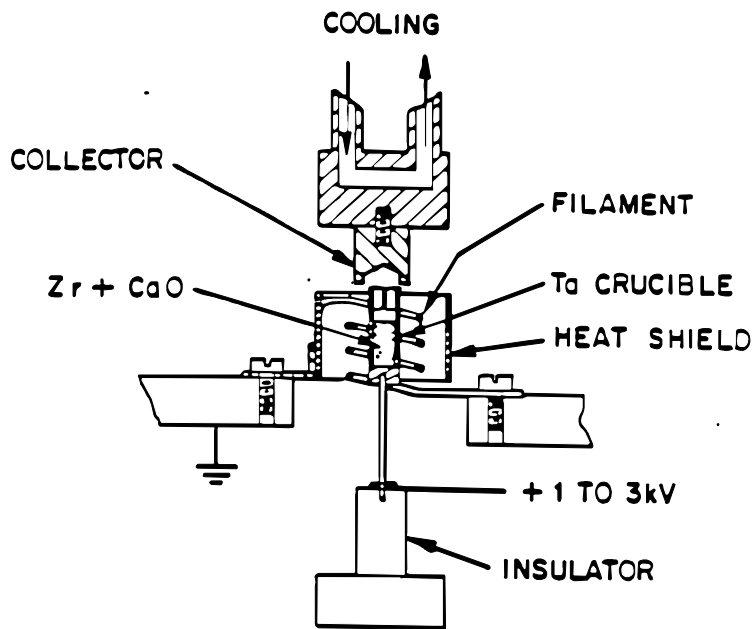

The upper figure shows the electron beam heated apparatus used to reduce calcium oxide to metal. The system is contained in a 12" diameter bell jar that is evacuated by a cryo-pump. The lower figure shows the small apparatus used to convert calcium metal into hydride.

A Negative Ion Cookbook

²¹Scandium

Isotopes

⁴⁶Sc -100%

Physical Properties

E.A. = 0.188 eV, I.P. = 6.54 eV, m.p. = 1541 °C, W.F. = 3.5 eV

Cathodes

We have tried three different types of cathodes; elemental, scandium hydride (ScH₂) and scandium oxide (ScO₂).

The elemental cathode, which consisted of a piece of 5 mm diameter rod pressed into a copper cathode, performed poorly and gave about 10 nA of ⁴⁶Sc⁻, 100 nA of ⁴⁶ScH⁻, and 150 nA of ⁴⁶ScO⁻. During this test, which was performed with a spherical ionizer source, it was noted that the cathode current was unusually low (~0.6 mA). This is a characteristic that we have come to associate with the Rare Earth elements and we believe is a result of ionizer contamination. Most of these elements have high melting points and low work functions and appear able to stick to the ionizer surface and reduce its ionization efficiency. The helical ionizer source seems less prone to poisoning and might be a better source to use with the Rare Earths.

Two cathodes were prepared from scandium hydride, made by heating scandium metal filings in hydrogen (the procedure was similar to that used to make calcium hydride - see Calcium). These performed much better and typically gave 0.4 to 0.7 μA of ⁴⁶ScH⁻ with weaker currents of ScH₂⁻, ScH₃⁻, and ScH₄⁻ (see spectrum overleaf). One of the cathodes ran for over seven hours. As with the element, cathode currents were low and we found it necessary to operate the source at a higher ionizer temperature than usual and with increased cesium vapor flow.

A third hydride cathode was made by heating and absorbing hydrogen in a millimeter-sized chunk of scandium metal. This absorbed considerable hydrogen and the resulting hydride was very brittle, shattered easily, and was simple to load into a standard cathode. The cathode was used in the helical ionizer source on our tandem and performed very well, producing 0.5 to 1.5 μA of ⁴⁶ScH⁻ for several hours. Scandium was successfully accelerated and positively identified.

A cathode containing scandium oxide was tried in the spherical ionizer source and performed very poorly. We suspect that poor performance was in part due to ionizer contamination.

Recommended Cathode

In view of the small electron affinity of scandium it is not surprising that the elemental current is small and the best ion to accelerate is ScH⁻. Undoubtedly the cathode material of choice is scandium hydride and we doubt it matters whether it is made from filings or chunks.

Molecular Ions

We are unsure whether scandium forms a dimer negative ion but it certainly forms four hydrides (ScH⁻, ScH₂⁻, ScH₃⁻ and ScH₄⁻) -- a characteristic shared by the other two members of its sub-group, yttrium and lanthanum, and most of the Rare Earths. It also forms an oxide ScO⁻ and we think that we observed a carbide ion (ScC⁻) from the elemental cathode.

Cathode

Scandium hydride

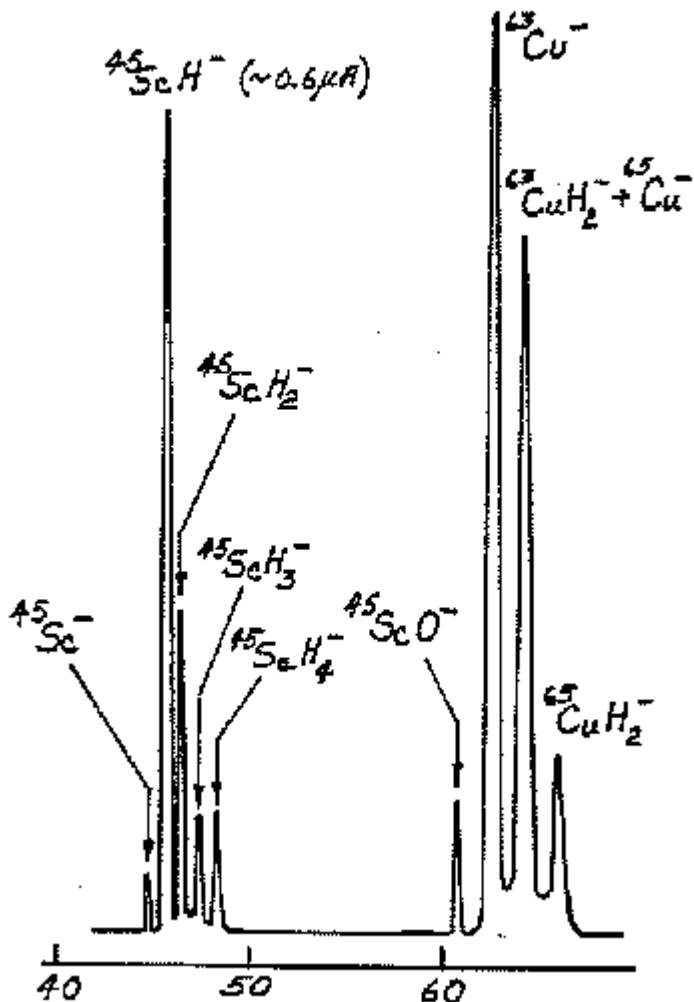

A negative ion spectrum obtained from a cathode containing scandium hydride prepared by absorbing hydrogen in scandium filings. Like the other members of its sub-group, yttrium and lanthanum, it forms four hydrides.

A Negative Ion Cookbook

²²Titanium

Isotopes

⁴⁶Ti - 8.0%, ⁴⁷Ti - 7.3%, ⁴⁸Ti - 73.8%, ⁴⁹Ti - 5.5%, ⁵⁰Ti - 5.4%

Physical Properties

E.A. = 0.079 eV, I.P. = 6.82 eV, m.p. = 1660 °C, W.F. = 4.33 eV

Cathodes

Many measurements have been made with cathodes of titanium metal, titanium hydride and deuteride (TiH₂, decomposes ~450 °C), and titanium nitride (TiN, m.p. 2930 °C). As might be expected from the small electron affinity (0.079 eV), the elemental ion is weak, but after an hour or two the ⁴⁸Ti⁻ current is usually 0.2 to 0.4 μA. The hydride is much more prolific and most metal cathodes exhibit a clear hydride contribution. In the spectrum shown overleaf on the left, the mass 49 peak is much more intense than expected from the isotopic abundance of ⁴⁹Ti and clearly contains a significant ⁴⁸TiH contribution.

Recommended Cathode

By far the most convenient and prolific negative ion is the hydride and we recommend making cathodes out of commercially available titanium hydride powder. This loads like a metal and performs extremely well in the source, usually giving 5 μA of ⁴⁸TiH⁻ within 30 minutes and often rising to more than 10 μA. These cathodes also produce 50 to 100 μA of H⁻ ions. Titanium hydride (or deuteride) is simple to make using a procedure similar to that described for making calcium hydride (see Calcium).

Molecular Ions

Titanium forms a dimer negative ion (Ti₂⁻) with about the same intensity as the elemental ion, and possibly a trimer but we have never observed it. As already mentioned, TiH⁻ is a prolific negative ion and overleaf on the right is shown a typical spectrum from a titanium hydride cathode. From the intensities of the various peaks it is evident that TiH₂⁻ and TiH₃⁻ must also exist and we think that both of these have about 15% the strength of TiH⁻. No measurements have been made with the cathode containing titanium oxide but usually most elemental cathodes show weak peaks corresponding to TiO⁻ (we believe it might be prolific). On a few occasions we have used cathodes containing titanium nitride and typically observe 4 to 6 μA of ⁴⁸TiN⁻.

BNL TVDG Experience

Ran 184.45/181.61 MeV at 14.2 MV from TiH. 1 nA analyzed. 6/5/95.

A Negative Ion Cookbook

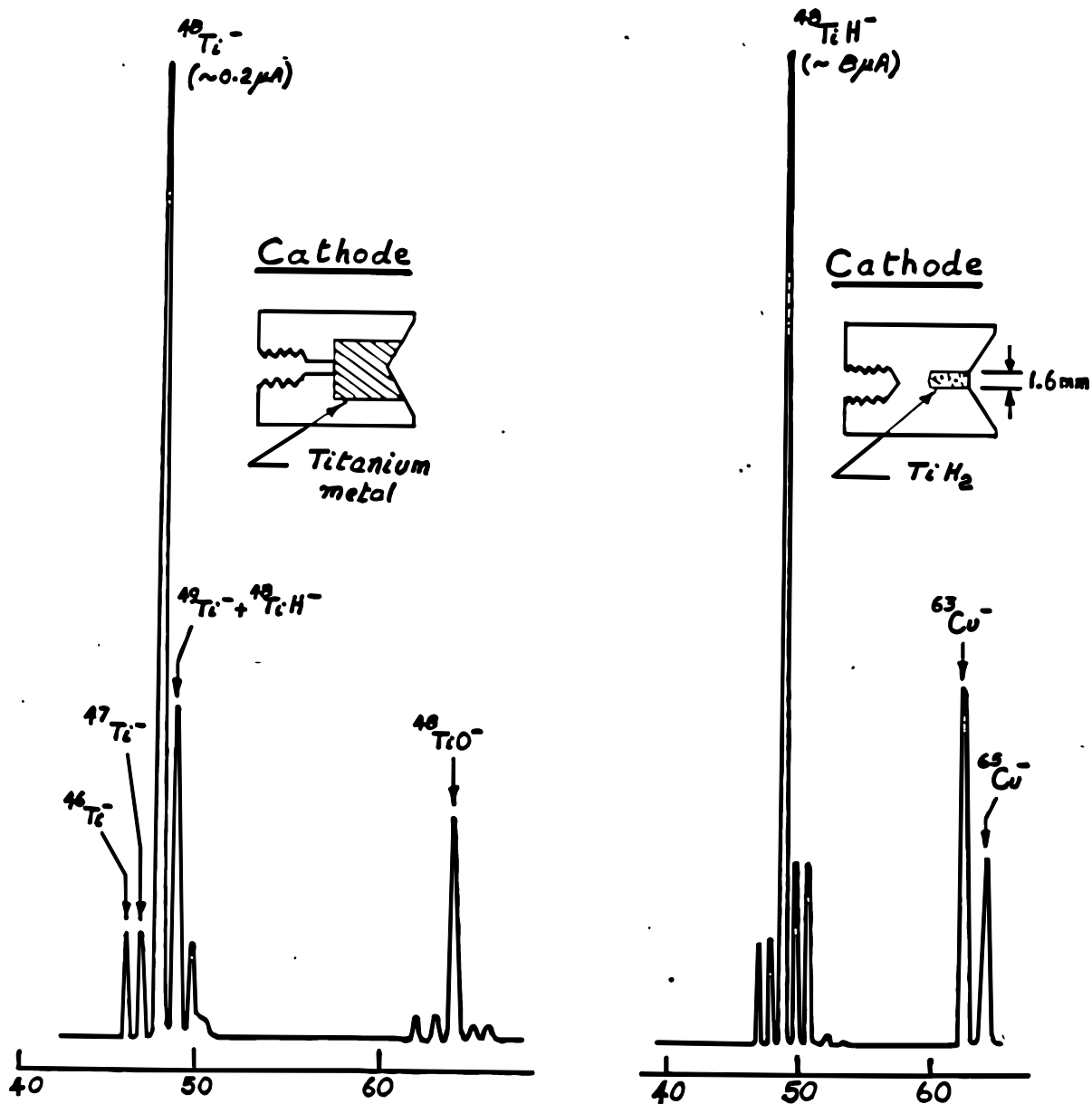

The spectrum on the left was obtained with a high purity titanium metal cathode. There can be no doubt that titanium forms an elemental negative ion but it is weak - usually the $^{48}\text{Ti}^-$ current is 0.2 to 0.4 μA. Note the clear presence of some $^{48}\text{TiH}^-$ in the mass 49 peak.

The right hand spectrum shows the prolific titanium hydride negative ions. Although the single hydride is dominant, both TiH_2^- and TiH_3^- are present with about 15% the strength of TiH^- .

A Negative Ion Cookbook

²³Vanadium

Isotope

⁶⁰V - 0.2%, ⁶¹V - 99.8%

Physical Properties

E.A. = 0.525 eV, I.P. = 6.74 eV, m.p. = 1890 °C, W.F. = 4.3 eV

Cathodes

Measurements have been made with three different cathodes; elemental, vanadium hydride, and vanadium metal filings mixed with powdered graphite. The elemental cathode performed well and its behavior was generally reminiscent of aluminum. At first the negative ion current increased slowly and at the end of an hour was still less than 1 μA . However, once a deep sputter crater had formed the current increased rapidly and after two hours exceeded 7 μA and eventually climbed to 9 μA .

The hydride cathode was prepared by heating vanadium filings in 600 Torr of hydrogen. The metal definitely absorbed some hydrogen but not nearly so much as calcium and titanium. Performance in the source was marginal and the largest current that we observed was 1.5 μA or ⁶¹VH⁻; VH₂⁻ and VH₃⁻ were evident but weaker. Since the H⁻ current was only 4 μA we doubt that the hydride was successfully formed.

Since niobium and tantalum, the other members of the subgroup, both form fairly intense carbide beams, a cathode was prepared from a mixture of vanadium filings and powdered graphite. This performed fairly well and was soon producing 3 to 4 μA of ⁶¹VC⁻ ions and weaker currents of VC₂⁻. A negative ion spectrum is shown on the right overleaf.

Recommended Cathode

Since the yield of the elemental ion is reasonable and about as expected from an element with an electron affinity of 0.53 eV, we recommend an elemental cathode. However, particularly if used with a spherical ionizer source, it should be pre-drilled, about 0.5 mm diameter by 2 mm deep -- this will greatly facilitate the rate of growth of the current.

Molecular Ions

Vanadium forms fairly strong hydride beams and in order of decreasing intensity we observed VH⁻, VH₂⁻, and VH₃⁻. It also forms a fairly strong carbide ion VC⁻ and less intensely VC₂⁻ (see spectrum overleaf). Although we made no special search for other molecular ions we observed an oxide (VO⁻) and probably a nitride (VN⁻) from a metal cathode. Unfortunately, we never looked to see if vanadium forms a dimer negative ion.

A Negative Ion Cookbook

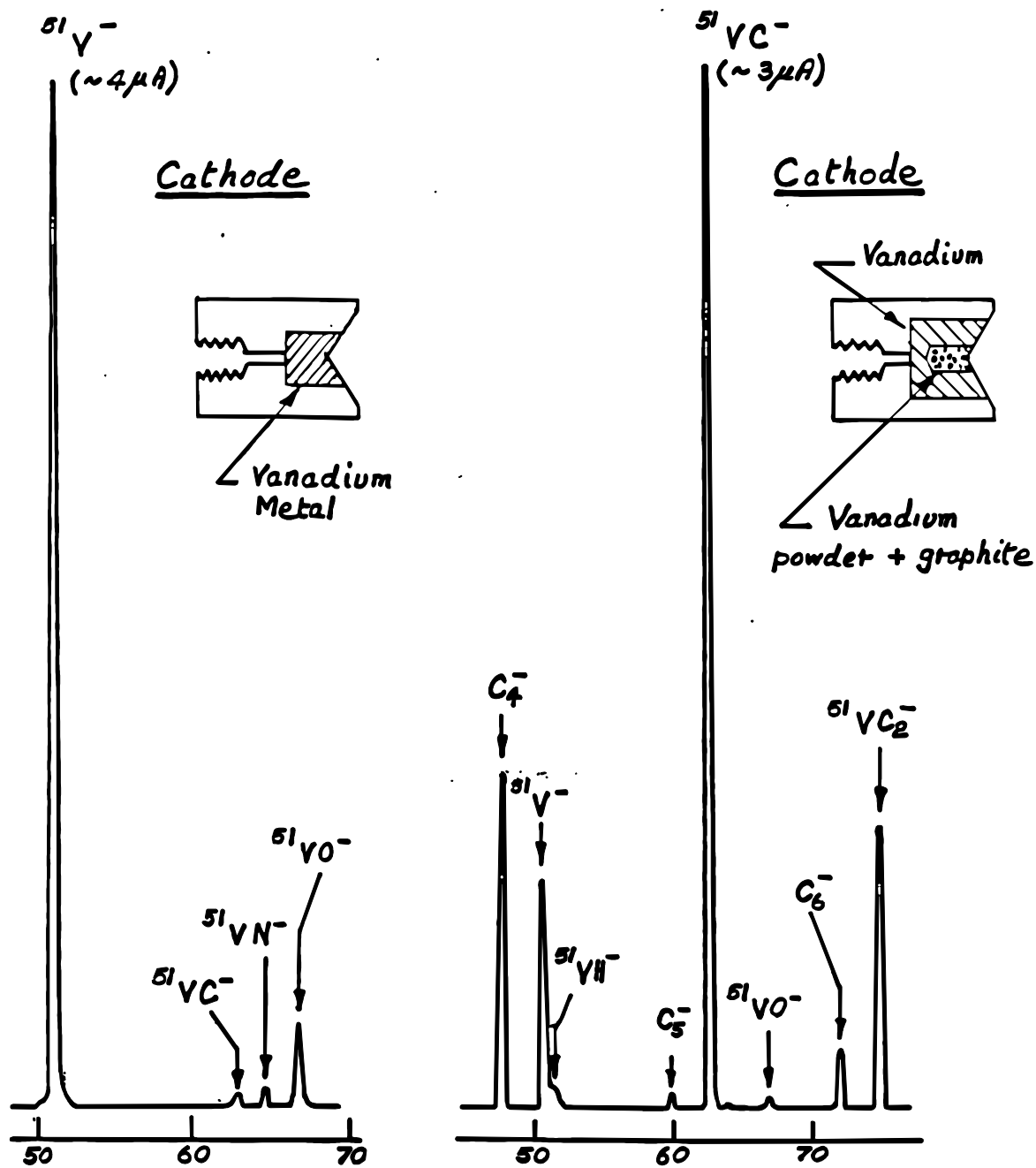

The spectrum on the left was obtained about 90 minutes after the metal cathode was introduced into the source. The extremely slow current growth could have been avoided by pre-drilling the vanadium. On the right is a spectrum from a cathode containing a mixture of vanadium filings and powdered graphite. As expected from comparison with niobium and tantalum, vanadium forms a reasonably intense carbide ion.

A Negative Ion Cookbook

²⁴Chromium

Isotope

⁶⁰Cr - 4.35%, ⁶²Cr - 83.79%, ⁶³Cr - 9.50%, ⁶⁴Cr - 2.36%

Physical Properties

E.A. = 0.666 eV, I.P. = 6.76 eV, m.p. = 1857 °C, W.F. = 4.5 eV

Cathodes

Measurements have been made with several cathodes loaded with elemental chromium, chromium powder mixed with graphite, and a gas cathode with hydrogen.

The elemental cathodes were made by tamping chromium powder or small chips broken from a chromium platelet into a standard copper cathode. They behaved similarly and after some initial sluggishness usually gave 1 μ A after 30 minutes and 4 or 5 μ A after an hour. Maximum current (~8 μ A) usually occurred after 2 to 3 hours and cathode lifetime was typically 4 hours. Overleaf is shown a negative spectrum from a powder cathode.

The chromium-graphite powder cathode performed reasonably well but the ⁶²CrC⁻ current was disappointing and typically about 1 μ A, comparable with the elemental current. ⁶²CrC₂⁻ was also observed but even weaker .

We were prompted to try a chromium gas cathode with hydrogen after learning that the electron affinity of CrH₂⁻ is greater than 2.5 eV¹). A drawing of the cathode and a portion of the negative ion spectrum is shown overleaf inset in the chrome metal spectrum. The chrome was in the form of small chips broken off a platelet (electrolytically produced), and these were hammered into a 2mm diameter hole in a copper cathode. Even though the chips were forcibly hammered the structure was quite porous and hydrogen could pass freely through it. The cathode was operated for about an hour, to form a sputter crater, before hydrogen was admitted. Almost immediately we observed 8 μ A of ⁶²CrH₂⁻, and after optimizing the gas flow, 12 μ A. The optimum partial pressure of hydrogen was about 7x10⁻⁷ Torr .

Recommended Cathode

For most purposes we like elemental cathodes and prefer to make these by hammering fine chromium powder into a standard cathode. The powder compacts surprisingly well and lifetime is excellent. For currents greater than 10 μ A we recommend a hydrogen gas cathode and believe, with some development, that 20 μ A or more or ⁶²CrH₂⁻ is achievable.

Molecular Ions

As is evident from the spectrum overleaf, chromium has a strong dimer (Cr₂⁻), approaching the elemental ion in intensity. It also forms a very strong dihydride (CrH₂⁻), with little evidence for CrH⁻ and CrH₃⁻. Chromium forms at least two carbides, CrC⁻ and CrC₂⁻, and two oxides, CrO⁻ and CrO₂⁻.

Reference

1) A.E.S Miller, C.S. Feigerle, and W.C. Lineberger, J. Chem. Phys. 84 (1986) 4127.

A Negative Ion Cookbook

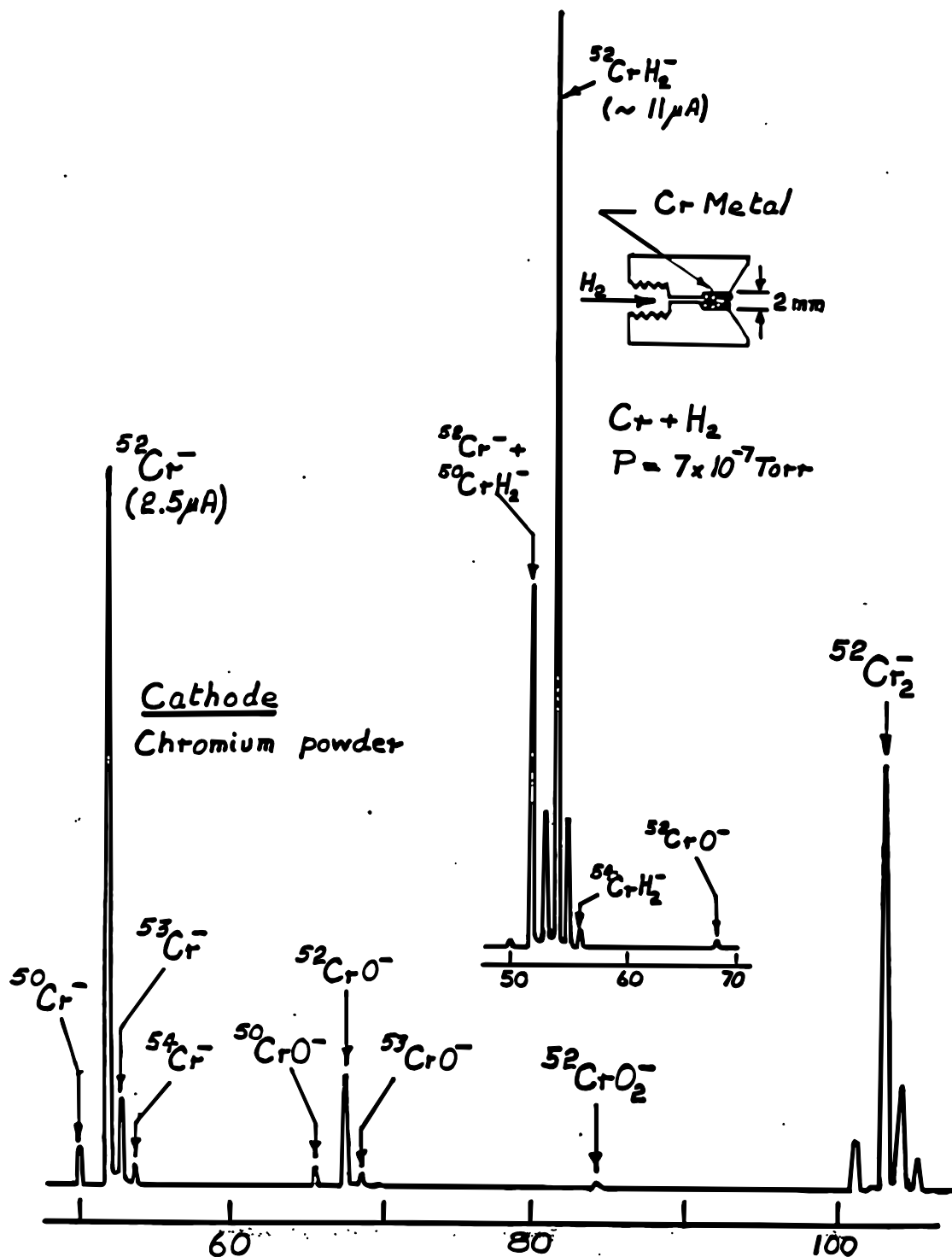

Showing a typical negative ion spectrum obtained with a cathode containing compressed chromium metal powder. Note the strong dimer that approaches the elemental ion in intensity. The inset spectrum, extending from mass 50 to 70, was obtained while passing hydrogen gas through the porous chromium metal cathode shown in the figure. CrH_2^- appears to be a very prolific negative ion, and we think with some development much larger currents are possible.

A Negative Ion Cookbook

²⁵Manganese

Isotopes

⁵⁵Mn - 100%

Physical Properties

E.A. < 0, I.P. = 7.43 eV, m.p. = 1244 °C, W.F. = 4.1 eV

Cathodes

Measurements have been made with cathodes containing elemental manganese, the element mixed with powdered graphite, manganese dioxide (MnO₂) and gas cathodes, which were used with hydrogen and ammonia. None gave rise to a peak at mass 55 and our measurements are completely consistent with manganese having a negative electron affinity.

Cathodes prepared from a mixture of crushed manganese and graphite powder ran well but the carbide currents were disappointing, typically 1.5 μA of ⁶⁵MnC⁻ and 3 μA of ⁵⁵MnC₂⁻. Manganese dioxide also ran well giving between 8 and 12 μA of MnO⁻ and weaker currents of MnO₂⁻ and MnO₃⁻. The ¹⁶O⁻ current from the latter cathode was unusually strong and on occasions reached 500 μA.

The most encouraging results were obtained with a gas cathode and hydrogen. The cathode, shown overleaf in an inset drawing, was made by hammering crushed manganese metal into a 3 mm diameter hole in a copper cathode. Prior to loading the manganese, a 0.5 mm diameter hole was drilled through the cathodes to admit the gas. Usually the cathode was run for 30 or 40 minutes to form a sputter crater before gas was admitted. Once hydrogen entered, a peak at mass 56 corresponding to ⁵⁵MnH⁻ grew rapidly and within minutes the current was usually larger than 1 μA (see spectrum overleaf). We were rather surprised to observe only the single hydride since MnH₂⁻ is reported to have an electron affinity of 0.44 eV¹). To search for this and other possible hydrides we made a series of measurements between mass 55 and 60 at progressively larger hydrogen pressures and the results of these are shown inset in the figure overleaf. Two weak peaks were observed corresponding to MnH₂⁻ and MnH₃⁻, both close to two orders of magnitude weaker than MnH⁻. Some measurements were also made with ammonia gas and although the results were similar the largest current observed was 0.2 μA of MnH⁻.

Recommended Cathode

Since ⁵⁵MnH⁻ is the best ion to accelerate in a tandem, we recommend a cathode containing crushed manganese through which hydrogen gas can be passed. Such cathodes produce fairly readily 1 to 2 μA and will last for several hours. Larger currents can be had, at the expense of some final energy, by accelerating ⁵⁵MnO⁻. The latter is a fairly prolific negative ion and cathodes containing manganese dioxide usually produce 8 to 10 μA.

Molecular Ions

We have often wondered if an element with negative electron affinity can form a stable dimer ion. Certainly manganese appears not to form a stable dimer but we did observe a peak of modest intensity corresponding to Mn₂H⁻ (see the spectrum opposite). As already discussed, manganese forms an intense single hydride and weak di and trihydrides. Molecular oxide ions were observed corresponding to MnO⁻, MnO₂⁻, and MnO₃⁻, with the first quite intense.

Reference

1) A.E.S. Miller, C.S. Feigerle, and W.C. Lineberger, J. Chem. Phys. 84 (1986) 4127.

A Negative Ion Cookbook

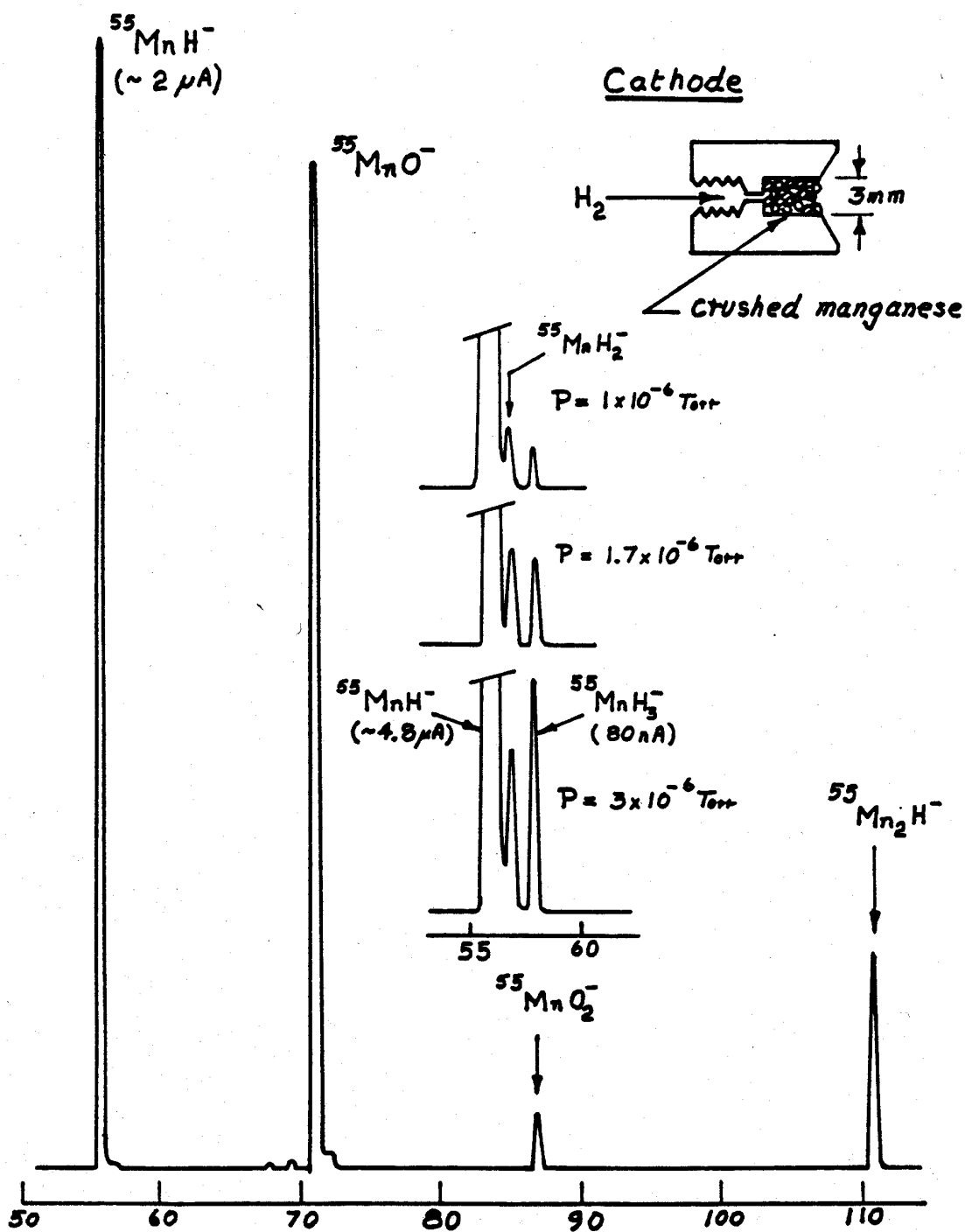

A negative ion spectrum obtained with a cathode similar to that shown above and with a hydrogen flow corresponding to a partial pressure of about 10^{-6} Torr. In addition to the fairly intense peak corresponding to $^{55}\text{MnH}^-$ note the weaker peak of $^{55}\text{Mn}_2\text{H}^-$. The inset spectra show, highly magnified, that MnH_2^- and MnH_3^- do exist but are extremely weak.

A Negative Ion Cookbook

²⁶Iron

Isotopes

⁵⁴Fe - 5.8%, ⁵⁶Fe - 91.72%, ⁵⁷Fe - 2.2%, ⁵⁸Fe - 0.28%

Physical Properties

E.A. = 0.163 eV, I.P. = 7.87 eV, m.p. = 1535 °C, W.F. = 5.27 eV

Cathodes

We have made many measurements with cathodes containing inserts of pure metallic iron including a determination of its ionization efficiency. Measurements have also been made with cathodes containing a mixture of compressed iron and graphite powders and an iron gas cathode with hydrogen.

Considering the small electron affinity, elemental cathodes perform remarkably well, and although slow rising usually produce 5 to 8 μA of ⁵⁶Fe⁻ ions. However, pre-drilling of the cathode is essential otherwise it takes two hours or more to attain maximum current. Ionization efficiency is also affected and an undrilled cathode had an efficiency of only 0.12% during the first hour of operation, rising to 1.2% during the third hour.

Cathodes prepared from iron and graphite powders perform well and usually the ⁵⁶FeC⁻ current is larger than ⁵⁶Fe⁻. However, the difference is small and barely outweighs the energy penalty of accelerating a molecule. A more prolific molecular ion is the hydride (FeH⁻) and with a metallic iron cathode, drilled (~ 0.5 mm diameter) to admit hydrogen, we had little difficulty producing 8 μA of ⁵⁶FeH⁻ with a small hydrogen flow (the partial pressure was ~ 10⁻⁶ Torr).

Recommended Cathode

Clearly there are pros and cons, but we recommend elemental metal. However, even when pre-drilled the ⁵⁶Fe⁻ current rises frustratingly slowly, and at first is dwarfed by the hydride (⁵⁶FeH⁻). Usually after 15 to 20 minutes the hydride disappears leaving 2 to 3 μA of elemental ions. The latter usually continues to grow and eventually attains a plateau around 8 μA .

Molecular Ions

Overleaf is shown a typical negative ion spectrum obtained from a cathode containing high purity iron. The most striking features are the near total disappearance of the hydrides, a strong dimer with about 50% the strength of the elemental ion, and a surprisingly strong (~1 μA) peak of ¹³³Cs⁻. The latter is present in most spectra but usually with an intensity of 20 to 40 nA, and only with aluminum have we observed such a strong ¹³³Cs⁻ beam (see Cesium). As already mentioned, iron readily forms hydrides and also shown overleaf is a spectrum from a gas cathode in use with hydrogen. Note that the single hydride (FeH⁻) is much stronger than the elemental ion and the clear presence of weaker beams of FeH₂⁻ and FeH₃⁻. The spectrum also contains a weak peak corresponding to ⁵⁶FeO⁻ and one mass unit higher an even weaker peak of ⁵⁶FeOH⁻. The cathode containing iron and graphite powders provided evidence for two carbides and typical currents from it were: ¹²C⁻ (154 μA), ⁵⁶Fe⁻ (2.3 μA), ⁵⁶FeC⁻ (4.0 μA), and ⁵⁶FeC₂⁻ (2.0 μA).

A Negative Ion Cookbook

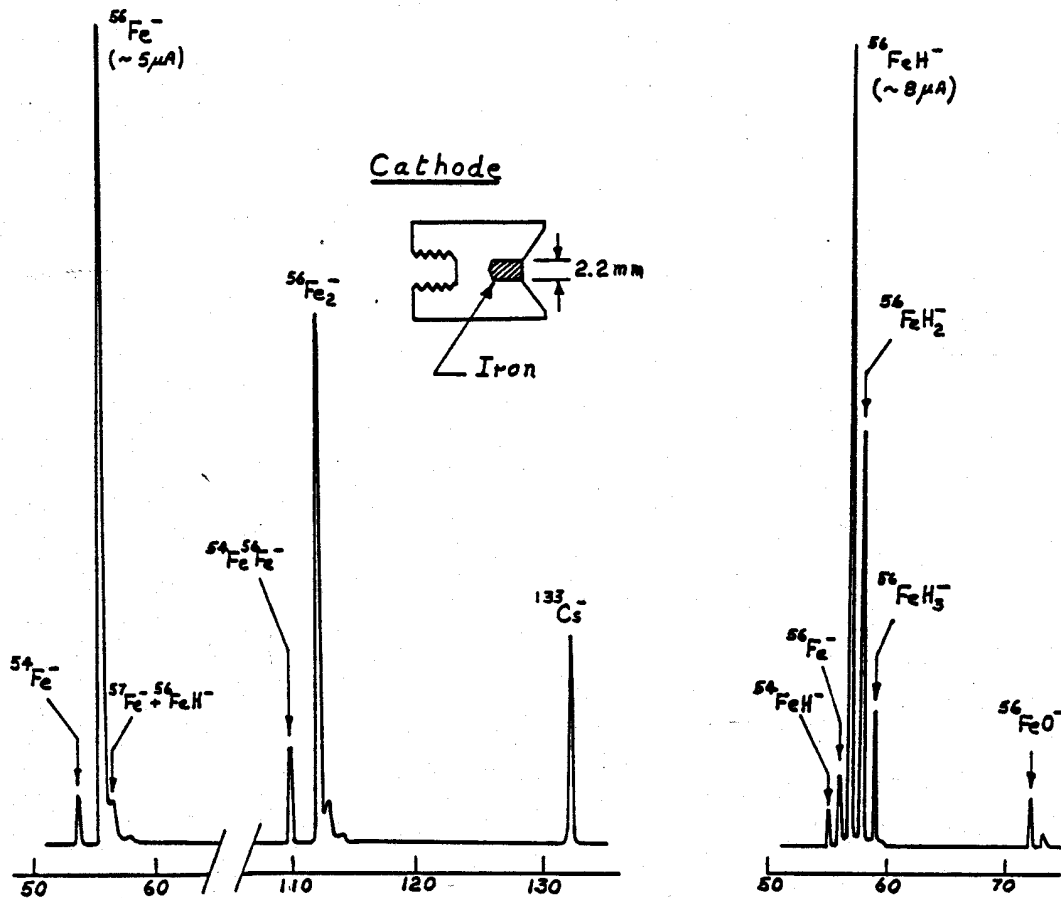

The spectrum on the left was obtained with a cathode similar to that shown in the sketch containing high purity iron. This particular cathode was not pre-drilled and required about two hours of operation before the $^{56}\text{Fe}^-$ current reached $5\mu\text{A}$. Note the presence of a strong dimer and a surprisingly strong peak corresponding to $^{133}\text{Cs}^-$. On the right is shown a spectrum obtained with a gas cathode and hydrogen. Iron appears to form three hydrides and the single hydride is particularly strong.

A Negative Ion Cookbook

²⁷Cobalt

Isotopes

⁵⁹Co - 100%

Physical Properties

E.A. = 0.661 eV, I.P. = 7.86 eV, m.p. = 1495 °C, W.F. = 5.0 eV

Cathodes

Although cobalt has only a modest electron affinity, about the same as lithium, the negative ion is surprisingly strong and we had little difficulty in obtaining 30 to 50 μA from cathodes containing inserts of 5 mm diameter cobalt rod. Consequently there was little reason to investigate alternatives and the only one we have tried was prepared from a mixture of cobalt and graphite powders.

Recommended Cathode

Cathodes containing cobalt metal perform spectacularly well, particularly if pre-drilled, and will produce well over 20 μA for 4 or 5 hours. We have also had good success with cathodes made from compressed cobalt powder, but these are difficult to pre-drill and the current may rise more slowly.

Molecular Ions

The spectrum from high purity rod is usually very clean with mere hints of a hydride and an oxide. However, the cobalt dimer is quite strong and typically it has about 30% the intensity of the elemental ion. Overleaf is shown a Spectrum obtained with a cathode containing a mixture of cobalt and graphite powders. Two carbide peaks are evident corresponding to $^{59}\text{CoC}^-$ and $^{59}\text{CoC}_2^-$, but both are much weaker than the elemental ion. Typical currents from this cathode were: $^{59}\text{C}^-$ (148 μA), $^{59}\text{Co}^-$ (39.6 μA), $^{59}\text{CoC}^-$ (4.6 μA), and $^{59}\text{CoC}_2^-$ (2.1 μA).

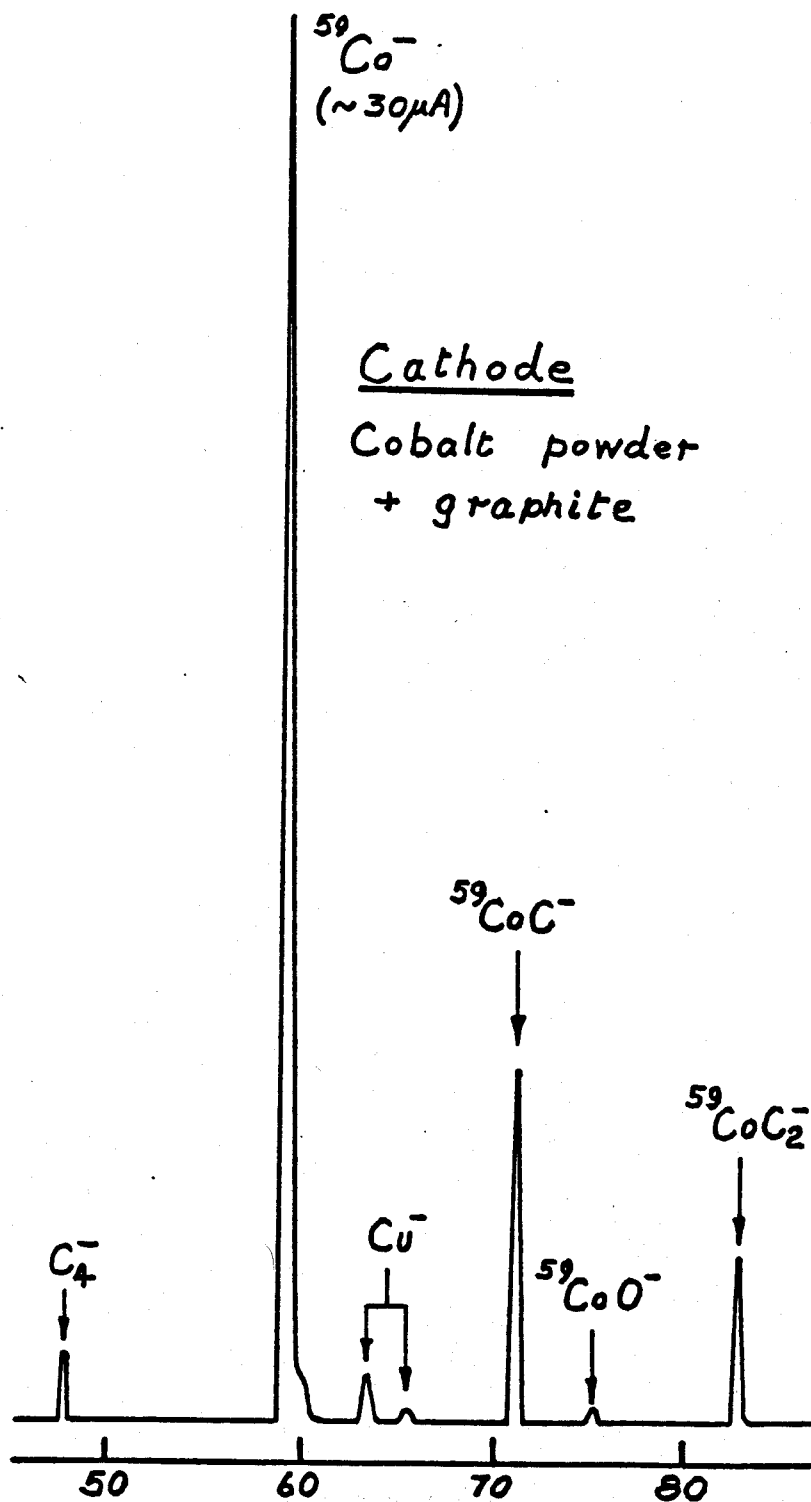

For an element with an electron affinity of only 0.661 eV, cobalt is a surprisingly prolific negative ion. In the spectrum above, obtained with a standard cathode loaded with a mixture of cobalt and graphite powders, the elemental ion dominates and is much stronger than either of the carbide negative ions.

A Negative Ion Cookbook

²⁸Nickel

Isotopes

⁵⁸Ni - 68.27%, ⁶⁰Ni - 26.10%, ⁶¹Ni - 1.13%, ⁶²Ni - 3.59%, ⁶⁴Ni - 0.91%

Physical Properties

E.A. = 1.156 eV, I.P. = 7.63 eV, m.p. = 1453 °C, W.F. = 5.15 eV

Cathodes

Nickel, like copper, is a very prolific negative ion and there is no need to use cathodes made out of anything other than the metal. However, we have performed a few tests with gas cathodes with hydrogen and ammonia to study the hydrides, and with mixtures of nickel and graphite powders. The latter studies were largely undertaken to find better methods of making carbon cathodes out of amorphous materials such as lampblack (see Carbon).

Recommended Cathode

Most of our cathodes have been prepared from 6 mm diameter high purity nickel rod hard pressed into a copper cathode, and were pre-drilled about 1 mm diameter by 1.25 mm deep - see inset sketch overleaf.

Performance

Cathodes of the above type usually give an instantaneous ⁵⁸Ni⁻ current of about 50 μA. This usually drops during the first few minutes to 40 μA and then steadily climbs to about 70 μA after an hour, and eventually levels around 80 to 85 μA. As with iron cathodes, we have measured the ionization efficiency by periodically removing the cathode and weighing to determine the amount of sputtered nickel. The ionization efficiency of a pre-drilled cathode during the first hour is about 4.3%, but as the sputter crater deepens the efficiency increases to between 8 and 9%. A typical negative spectrum is shown overleaf.

Molecular Ions

Usually few molecular ions are observed from high purity nickel cathodes except for a rather weak dimer with about 2 to 3% the strength of the elemental ion. To study the hydride, measurements have been made with a gas cathode using both hydrogen and ammonia. Surprisingly, the former is the more effective, and overleaf on the right is shown the effect of adding hydrogen. Nickel appears to form a strong dihydride and the ⁵⁸NiH₂⁻ peak has about the same intensity as ⁵⁸Ni⁻. The single and triple hydrides are exceptionally weak. Measurements with a cathode containing a mixture of nickel powder and graphite filings revealed two weak carbides, NiC⁻ and NiC₂⁻. Typical currents from this cathode were: ¹²C⁻ (126 μA), ⁵⁸Ni⁻, (36 μA), ⁵⁸NiC⁻ (1 μA), and ⁵⁸NiC₂⁻ (1.6 μA).

A Negative Ion Cookbook

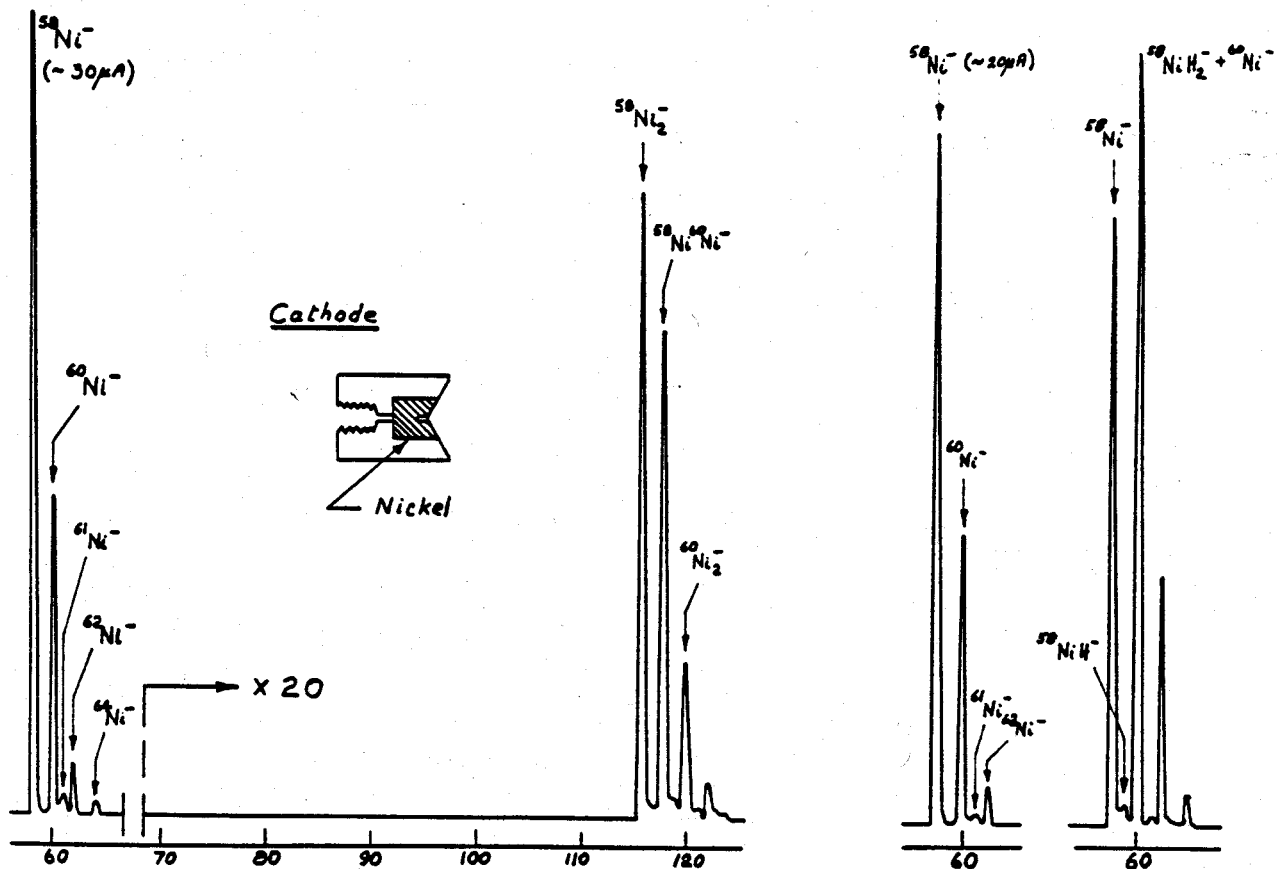

The clean spectrum on the left is typical of a high purity nickel cathode of the type shown in the sketch. Pre-drilled cathodes like this frequently produce 30 to 40 μA of $^{58}\text{Ni}^-$ almost immediately, rising to 70 or 80 μA as a deep sputter crater forms. On the right are shown two spectra obtained with a nickel gas cathode, the left one before hydrogen and the right one with hydrogen at a partial pressure of about 10^{-8} Torr. NiH^- and NiH_3^- appear quite weak while NiH_2^- rivals the intensity of the elemental ion.

A Negative Ion Cookbook

29Copper

Isotopes

^{63}Cu - 69.17%, ^{65}Cu - 30.83%

Physical Properties

E.A. = 1.228 eV, I.P. = 7.72 eV, m.p. = 1083 °C, W.F. = 4.65 eV

Cathodes

Since our standard cathodes are made from copper we have made numerous measurements with it and frequently use it to assess the condition of the source. We normally expect a pre-drilled copper cathode to produce almost instantaneously 50 to 60 μA of $^{63}\text{Cu}^-$. This usually falls during the first 5 or 10 minutes to around 40 to 45 μA and then begins a gradual climb. After an hour the current is usually 70 to 75 μA and after two hours it levels between 85 and 100 μA .

On several occasions and under various conditions we have measured the ionization efficiency of copper. During the first hour, a pre-drilled cathode has an efficiency of about 4%, but as the sputter crater develops the efficiency increases and can rise as high as 10%.

Molecular Ions

From a pure copper cathode it is unusual to observe any molecular ions other than the dimer (Cu_2^-) and the trimer (Cu_3^-). These are much weaker than the elemental ion and roughly the ratio of Cu^- : Cu_2^- : Cu_3^- is 100:3:2. Frequently when a copper cathode is loaded with an oxide peaks are observed corresponding to $^{63}\text{CuO}^-$ and $^{65}\text{CuO}^-$ and occasionally, much weaker, corresponding to a dioxide. Indeed it is quite common to observe CuX^- ions from a cathode loaded with some metallic element X.

To investigate the hydrides of copper, measurements have been made with a gas cathode with hydrogen and ammonia. Rather surprisingly, the interaction with hydrogen was very weak, and only at high flow rates did we observe a small peak corresponding to $^{65}\text{CuH}_2^-$ ($^{63}\text{CuH}_2^-$ is masked by $^{65}\text{Cu}^-$). Ammonia was much more effective and shown overleaf are spectra measured with and without ammonia. The effect of the ammonia was twofold -- it surprisingly increased the elemental current by about 20% and it produced a very strong dihydride, rivaling the elemental ion in intensity. Extremely weak peaks were observed corresponding to the single hydride.

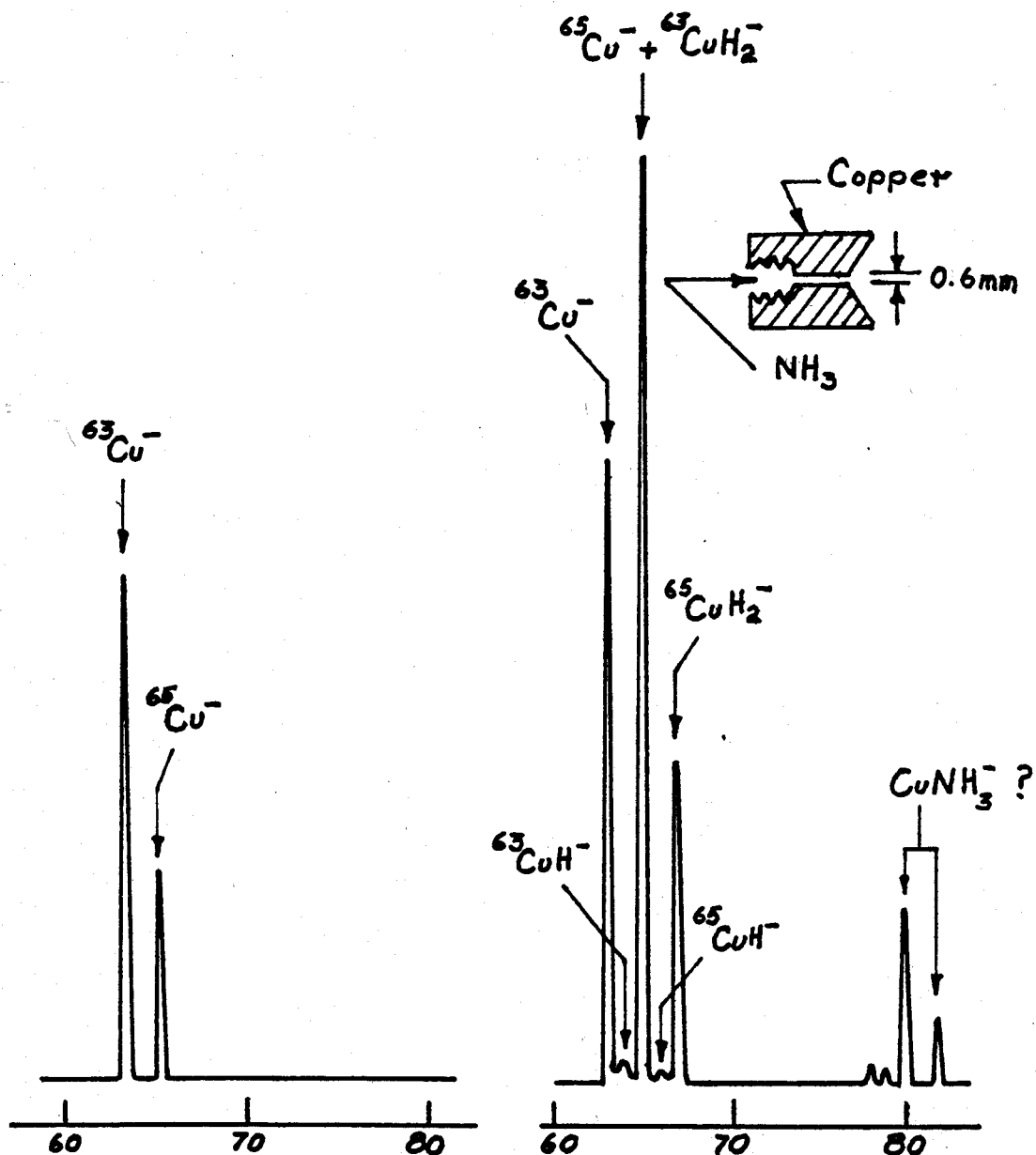

Spectra obtained with the type of cathode shown in the sketch; on the left, before ammonia, and on the right, with ammonia. The ammonia not only produced an intense dihydride negative ion, but surprisingly seemed to increase the intensity of the elemental ion. The single hydride $^{63}\text{CuH}^-$ is very weak.

A Negative Ion Cookbook

³⁰Zinc

Isotopes

⁶⁴Zn - 48.6%, ⁶⁶Zn - 27.9%, ⁶⁷Zn - 4.1%, ⁶⁸Zn - 18.8%, ⁷⁰Zn - 0.6%

Physical Properties

E.A. < 0, I.P. = 9.39 eV, m.p. = 420 °C, W.F. = 4.33 eV

Cathodes

Measurements have been made with an elemental cathode, a gas cathode with hydrogen, a cathode containing a mixture of zinc and graphite powders, and one containing zinc oxide (ZnO, m.p. = 1975 °C).

The elemental cathode was a disappointment but at least it confirmed that zinc has a negative electron affinity. The only ions that we observed before the cathode sputtered through were the oxides. A gas cathode, consisting of a zinc insert with a 0.6 mm diameter hole to admit hydrogen, performed much better. Overleaf are shown spectra measured before and during hydrogen admission. The effect of the hydrogen was spectacular and clearly evident are peaks corresponding to ZnH⁻ and ZnH₃⁻, but with little or no ZnH₂⁻. The ⁶⁴ZnH⁻ current was typically 0.3 μA. The effect of the hydrogen on the oxides was unusual and surprisingly produced hydroxide ions that surpassed the oxides in intensity.

The cathode containing a mixture of zinc and graphite powders ran smoothly producing excellent currents of carbon and its many polyatomic ions, but the zinc carbide currents were lamentable. Amidst a very complex spectrum, the largest currents we observed were 20 nA of ⁶⁴ZnC⁻ and 120 nA of ⁶⁴ZnC₂⁻. Zinc oxide proved an excellent cathode material and within minutes was producing 2 to 3 μA of ⁶⁴ZnO⁻ ions, rising over a period of an hour to 6 to 7 μA. The ¹⁶O⁻ currents were also excellent and in the 200 to 300 μA range.

Recommended Cathode

The choice is between a zinc/hydrogen gas cathode and zinc oxide. The latter is convenient, runs well and conservatively yields 1 or 2 μA of ⁶⁴ZnO⁻; the only disadvantage is the energy loss resulting from the acceleration of a molecule. On the other hand, there is essentially no energy loss with the hydride but the current is less and typically 0.2 μA. We favor the oxide.

Molecular Ions

Like most elements with a negative electron affinity, zinc does not appear to form a stable dimer. As already mentioned, it does form two fairly intense hydride ions, ZnH⁻ and ZnH₃⁻. The carbides, ZnC⁻ and ZnC₂⁻, are usually weak, and by far the most intense molecular ion that we have observed is the oxide, ZnO⁻. Shown below is a typical negative ion spectrum obtained with a cathode containing zinc oxide. In addition to the peaks corresponding to ZnO⁻ note the presence of a weak dioxide.

BNL TVDG Experience:

Gw and DG ran ZnO+tin in the PSX-120. With boiler, 9 nA in a few minutes. DO NOT USE 12-20, as it is badly contaminated with an unknown ion (probably iron).

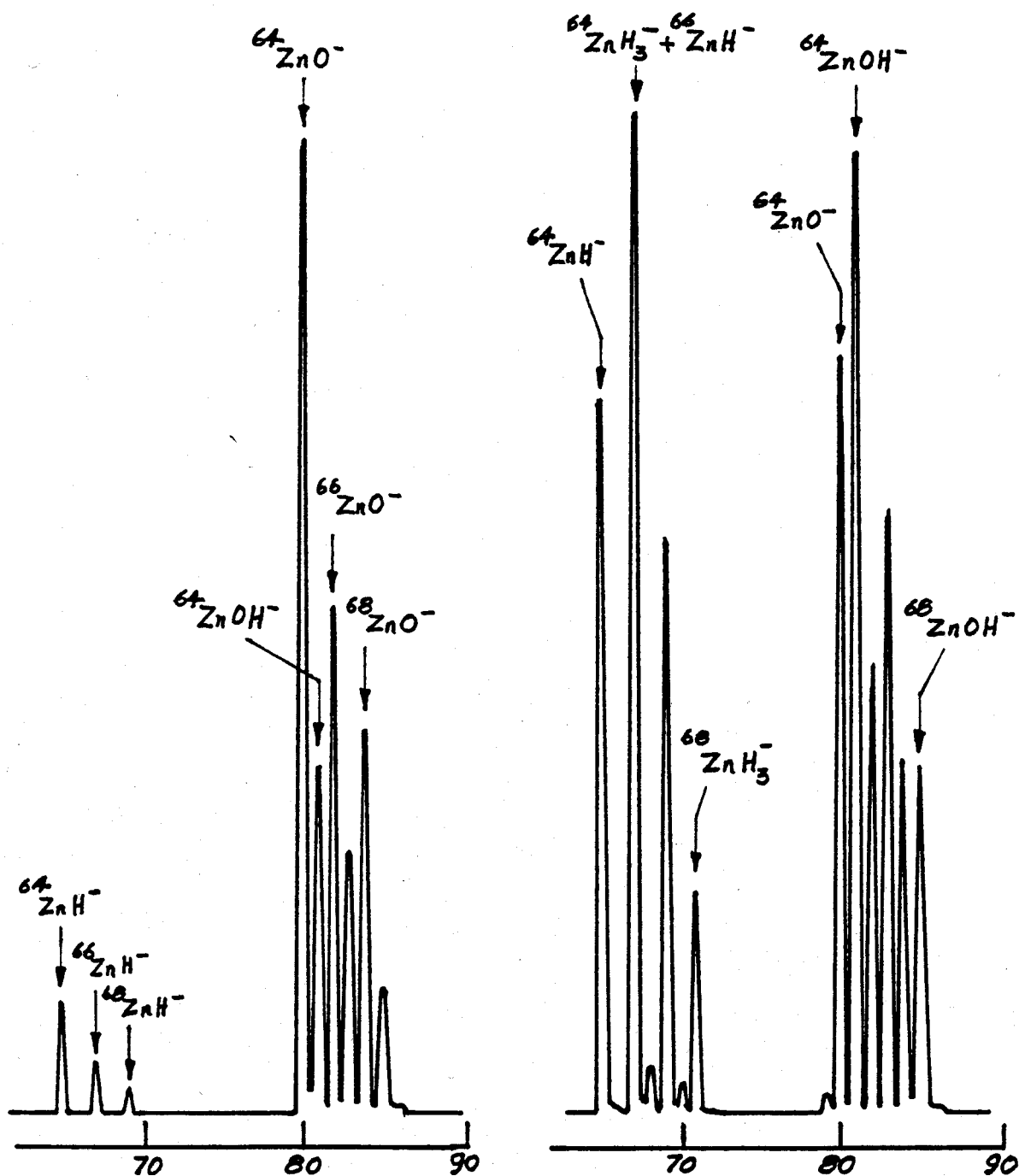

Spectra obtained with a zinc gas cathode and hydrogen. The spectrum on the left was obtained before hydrogen was admitted, but it appears likely that the needle valve might have been leaking, and on the right is shown the effect of hydrogen. Note that zinc forms ZnH^- and ZnH_3^- ions with about equal intensity while ZnH_2^- is totally absent. The current of $^{64}\text{ZnH}^-$ was typically $0.3 \mu\text{A}$ and the hydrogen pressure in the source was about 10^{-6} Torr.

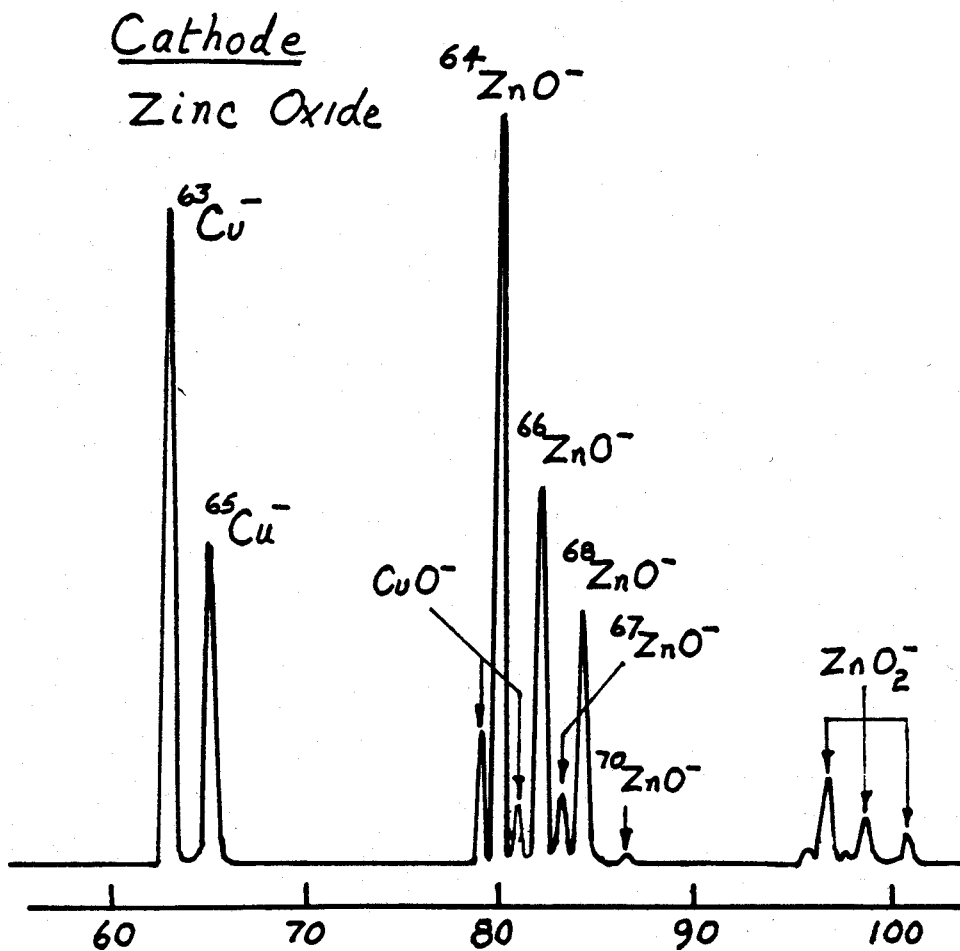

A spectrum obtained with a cathode containing zinc oxide. This ran well and the current of $^{64}\text{ZnO}^-$ was typically 3 to 4 μA .

A Negative Ion Cookbook

³¹Gallium

Isotopes

⁶⁹Ga - 60.4%, ⁷¹Ga - 39.6%

Physical Properties

E.A. = 0.3 eV, I.P. = 6.0 eV, m.p. = 29.8 °C, W.F. = 4.2 eV

Cathodes

The extremely low melting point of elemental gallium precludes its direct use in a cathode. However, we have made measurements on three compounds, gallium oxide (Ga₂O₃, m.p. = 1900 °C), gallium phosphide (GaP, m.p. = 1348 °C), and gallium arsenide (GaAs, m.p. = 1238 °C).

In light of the small electron affinity of gallium we were not surprised that none produced large elemental currents. However, the oxide did give about 100 nA of ⁶⁹Ga⁻, which might be sufficient for some purposes. A more prolific negative ion is the oxide and we had no difficulty in obtaining 5 to 15 μA of ⁶⁹GaO⁻.

The gallium phosphide cathode produced about 50 nA of ⁶⁹Ga⁻, and rather surprisingly 10 to 12 μA of ⁶⁹Ga³¹P⁻. The elemental current was even weaker from the arsenide but it did produce good currents of arsenic and 3 to 5 μA of ⁶⁹GaAs⁻.

Recommended Cathode

The gallium oxide ran well and in addition to producing 100 nA of ⁶⁹Ga⁻ gave strong oxide currents (see the spectrum overleaf). Our experience with aluminum oxide suggests that with persistence and some experimentation the elemental current might be increased to about 0.25 μA.

Molecular Ions

Like aluminum, gallium probably makes several negative hydride ions, but these are difficult to observe with cathodes made from compounds and none were identified. Also a strong dimer might be expected and in the gallium arsenide spectrum we observed three peaks with the correct intensity ratios to correspond to ⁶⁹Ga₂⁻, ⁶⁹Ga⁷¹Ga⁻ and ⁷¹Ga₂⁻. Although weak they had several times the intensity of the elemental ions. Again like aluminum, gallium forms a very strong oxide (GaO⁻) and a weak dioxide (GaO₂⁻).

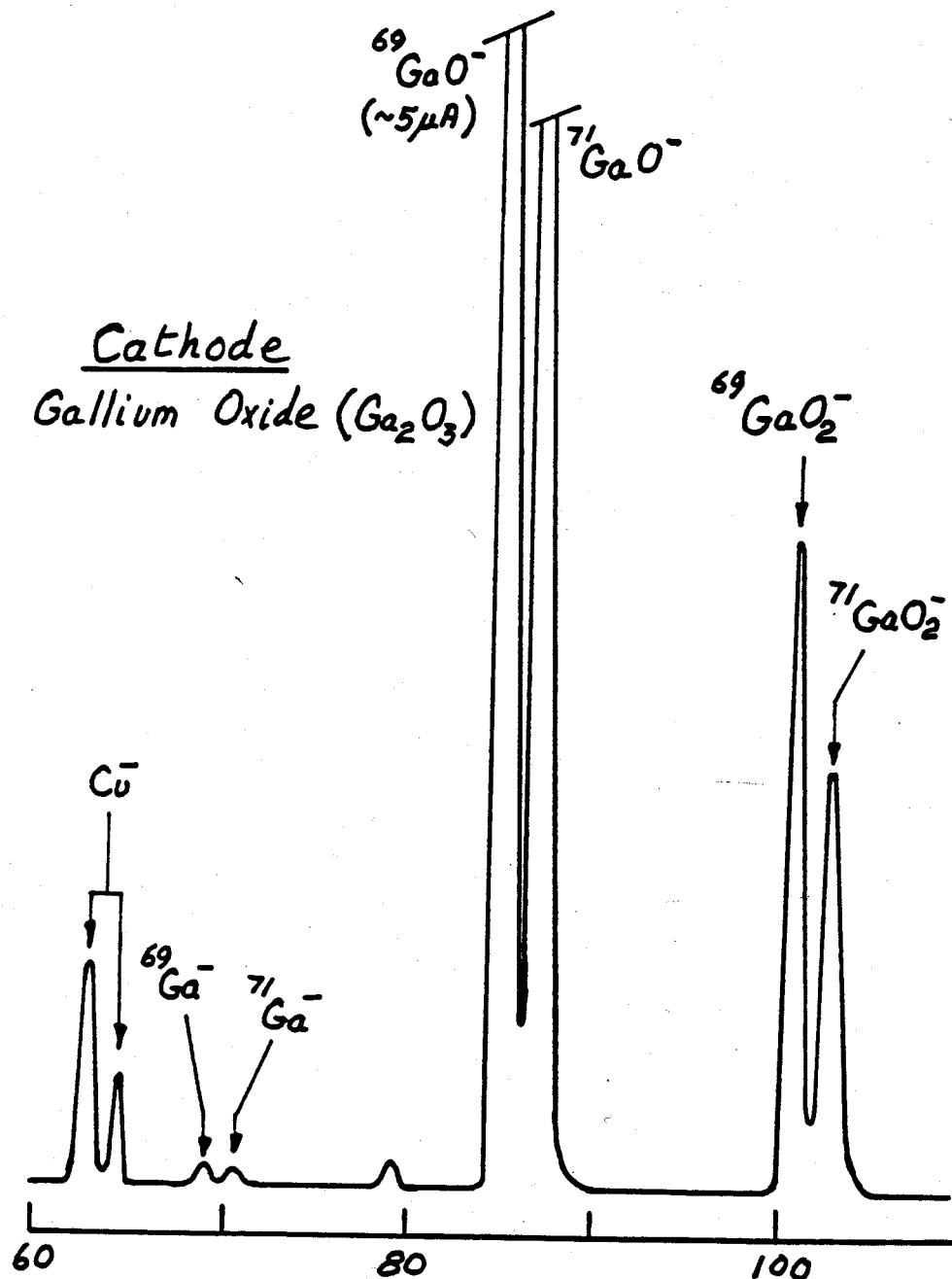

Gallium oxide, like aluminum oxide, runs smoothly in the source and gives up to 200 μA of $^{16}\text{O}^-$ and 17 μA of $^{69}\text{GaO}^-$. We think that with some persistence and experimentation that 250 nA of $^{69}\text{Ga}^-$ is a reasonable goal but the largest current we obtained during a single attempt was 120 nA.

A Negative Ion Cookbook

³²Germanium

Isotopes

⁷⁰Ge - 20.5%, ⁷²Ge - 27.4%, ⁷³Ge - 7.8%, ⁷⁴Ge - 36.5%, ⁷⁶Ge - 7.8%

Physical Properties

E.A. = 1.2 eV, I.P. = 7.88 eV, m.p. = 937.4 °C, W.F. = 5.0 eV

Cathodes

Germanium, like silicon, is a prolific negative ion, and since the element produces excellent currents we have not tried other materials. Initially we attempted to make cathodes out of cores cut from high-purity germanium crystal but these proved very difficult to mount without breaking. A better and more convenient procedure is to crush scrap pieces of germanium crystal (it is surprisingly soft) and to hammer it into a 1.6 mm diameter hole in a standard cathode.

Recommended Cathode

Crushed germanium crystal as described above.

Performance

The crushed germanium cathodes perform very well. They run smoothly and usually give 5 or 6 μA of ⁷⁰Ge⁻ almost instantaneously, slowly rising to about 12 μA . However, germanium does sputter quickly and at these currents a cathode only lasts for about 3 hours.

Molecular Ions

Like carbon and silicon, germanium forms several polyatomic negative ions and the dimer frequently rivals the elemental ion in intensity; see the Spectrum overleaf. Remarkably we have observed no molecular ions, but this is probably due to the purity of the cathode rather than a property of germanium. The intensities of the elemental ions closely match their isotopic abundancies, indicating little if any presence of a hydride.

A Negative Ion Cookbook

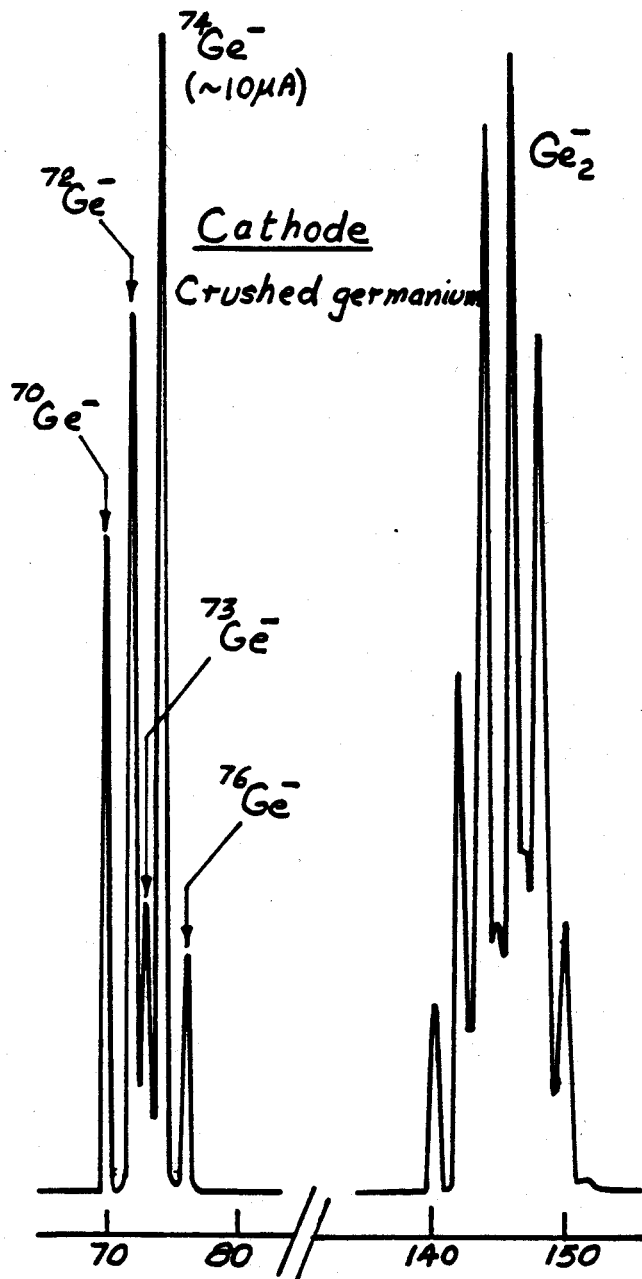

Portions of the extremely clean spectrum from a cathode containing crushed high-purity germanium crystal. Note the intensity of the complex dimer equals that of the elemental ion. Other than the polyatomic ions no molecular ions were observed.

A Negative Ion Cookbook

³³Arsenic

Isotopes

⁷⁵As - 100%

Physical Properties

E.A. = 0.747 eV, I.P. = 9.81 eV, m.p. = 817 °C, W.F. = 3.75 eV

Cathodes

Because of its high vapor pressure and toxicity we have never used the element in a cathode. A particularly convenient compound that we have used is gallium arsenide (GaAs, m.p. = 1238 °C). Our sample was in the form of a wafer, about 0.2 mm thick, and we loaded it by hammering and crushing small pieces into a 1.6 mm diameter hole in a standard cathode. It loaded well and looked very compact and metallic after hammering.

Performance

The two cathodes that we tried ran very well; the ⁷⁵As⁻ current climbed quickly and for most of the time was between 15 and 25 μA. No attempt was made to push the source and we suspect that 50 μA might be obtainable without too much difficulty. However, gallium arsenide sputters very quickly and cathode lifetime was short, typically only two hours. A negative ion spectrum from a gallium arsenide cathode is shown overleaf.

Molecular Ions

Like phosphorus, arsenic has a fairly strong dimer having 15 to 20% the intensity of the elemental ion. Consistent with the high purity of the gallium arsenide, no hydride was observed, but a very weak peak was identified corresponding to the oxide ion AsO⁻. The only other molecular ions were ⁶⁹GaAs⁻ and ⁷¹GaAs⁻ and these were unusually strong, having about half the strength of As⁻.

BNL TVDG Experience

GW and DG get 15-20nA very quickly from PSX120, using GaAs target.

A Negative Ion Cookbook

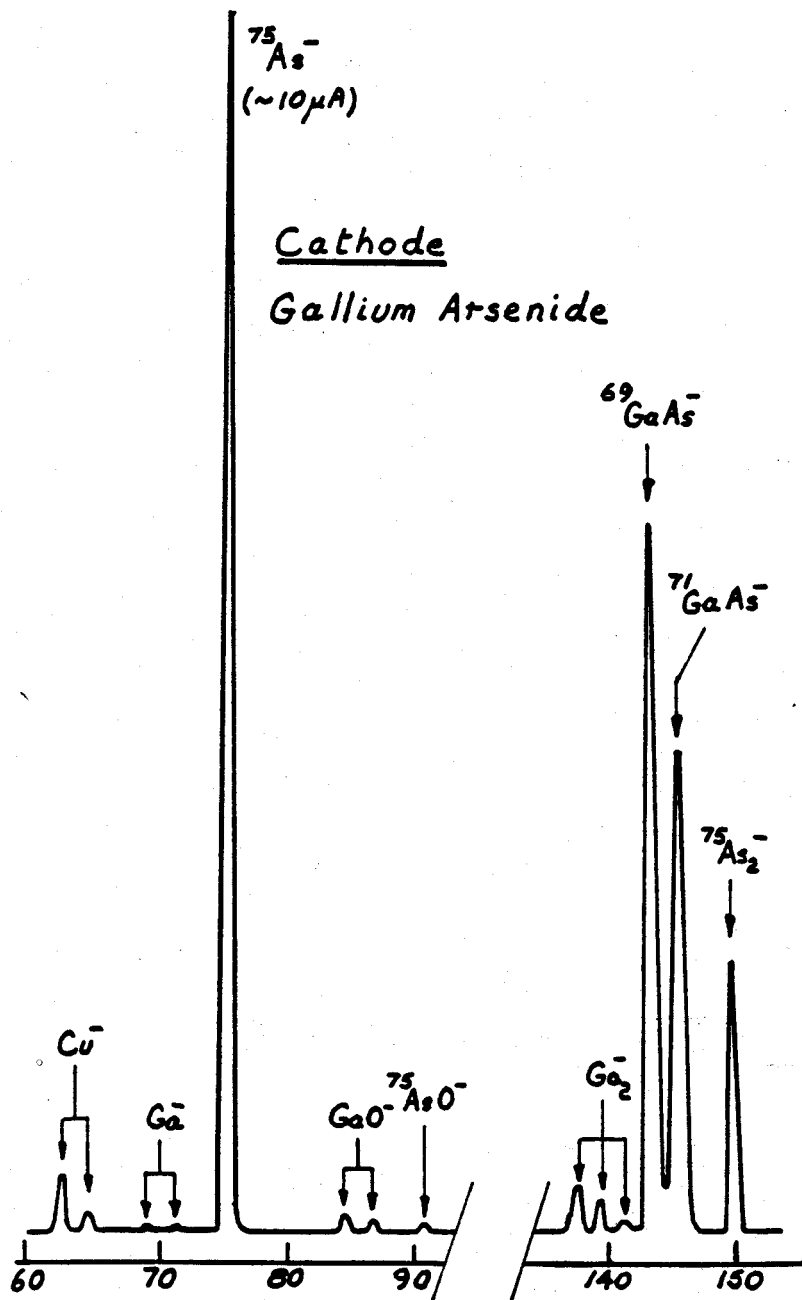

Spectrum obtained from a cathode containing a piece of crushed gallium arsenide wafer. For much of the time the $^{75}\text{As}^-$ current was between 15 and 25 μA , but the cathode sputtered quickly and only lasted for two hours. Note the fairly strong dimer ion $^{75}\text{As}_2^-$ and the intense peaks corresponding to $^{69}\text{GaAs}^-$ and $^{71}\text{GaAs}^-$.

A Negative Ion Cookbook

³⁴Selenium

Isotopes

⁷⁴Se – 0.9%, ⁷⁶Se – 9.0%, ⁷⁷Se – 7.6%, ⁷⁸Se – 23.5%, ⁸⁰Se – 49.6%, ⁸²Se – 9.4%

Physical Properties

E.A. = 2.021 eV, I.P. = 9.75 eV, m.p. = 217 °C, W.F. = 5.9 eV

Cathodes

Selenium, like sulfur, has an unusually large vapor pressure that prevents its use in a cathode. The selenides are better choices and we have tried two, barium and cadmium selenide. Both performed well but the barium selenide gassed fairly heavily and it is possible that it contained some excess elemental selenium (its origin was uncertain).

Recommended Cathode

Cadmium selenide (CdSe, m.p. > 1350 °C) performed excellently and left little to be desired. It loaded well, ran smoothly and produced a conservative 20 to 40 μA of ⁸⁰Se⁻. Lifetime is also good and this particular cathode performed for over 3 hours.

Molecular Ions

Unfortunately little effort was devoted to searching for molecular ions and we are unsure whether selenium forms a dimer. From comparison with oxygen and sulfur it is likely that it does, but probably weakly. The intensities of the elemental ion peaks (see spectrum overleaf) correspond very closely to the isotopic abundancies and provide scant evidence for a hydride. Indeed, the only molecular ion that we observed with some degree of certainty was the oxide.

A Negative Ion Cookbook

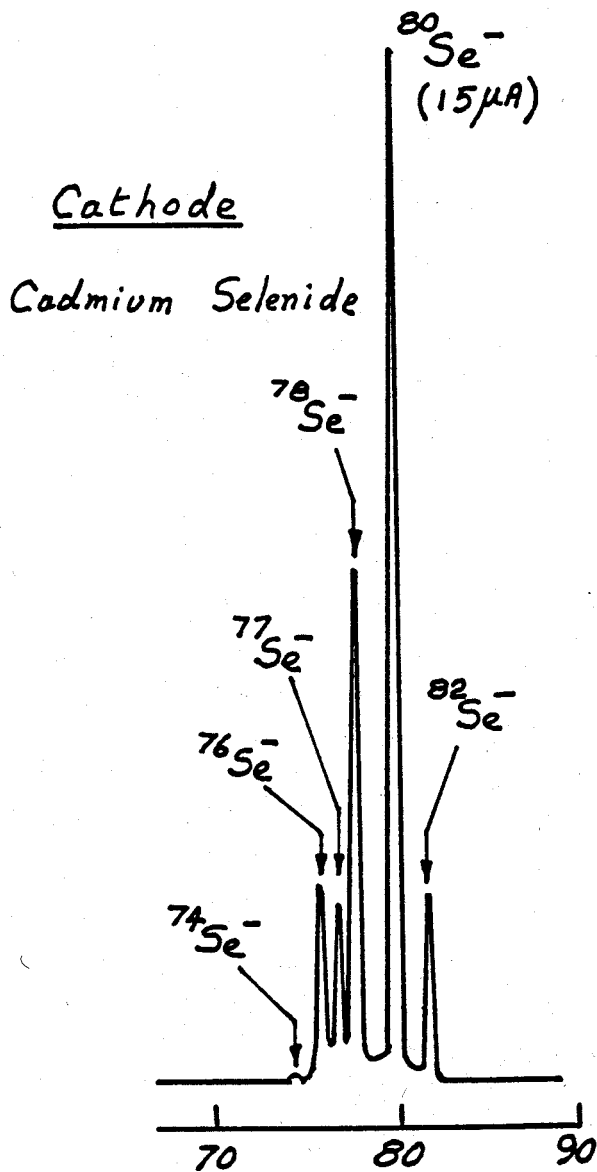

Cadmium selenide is an excellent choice of cathode material and can be relied upon to produce 20 to 40 μA of $^{80}\text{Se}^-$ ions for several hours.

A Negative Ion Cookbook

³⁵Bromine

Isotopes

⁷⁹Br - 50.69%, ⁸⁰Br - 49.31%

Physical Properties

E.A. = 3.365 eV, I.P. = 11.84 eV, m.p. = -7.2 °C

Cathodes

The only cathode material that we have tried is potassium bromide (KBr, m.p. = 730 °C) but it is likely that other bromides will perform as well or better. Since potassium bromide is hygroscopic we normally melt a small piece on a heavy metal block forming a bead of clear liquid which turns white on cooling. The bead is quickly crushed and mixed with about an equal volume of silver powder and then loaded without delay into a cathode.

Materials such as potassium bromide, even when mixed with silver powder tend to run erratically and we find it beneficial to reduce the reservoir temperature and to use a lower cathode voltage. In spite of this, ⁷⁹Br⁻ currents are large and usually in the 15 to 30 μA range. Cathode life is reasonably good and with currents like these is typically 4 or 5 hours.

Molecular Ions

The only molecular ion that we have observed is the dimer, Br₂⁻. This is extremely weak and with 30 μA of ⁷⁹Br⁻, the ⁷⁹Br₂⁻ current is about 40 nA.

A Negative Ion Cookbook

³⁶Krypton

Isotopes

⁷⁸Kr - 0.35%, ⁸⁰Kr - 2.25%, ⁸²Kr - 11.6%, ⁸³Kr - 11.5%, ⁸⁴Kr - 57.0%, ⁸⁶Kr - 17.3%

Physical Properties

E.A. < 0, I.P. = 14.0 eV, m.p. – gas

Cathodes

Like all of the noble gases heavier than helium, krypton does not form a stable or a metastable negative ion. However, Minehara et al.¹⁾ succeeded in producing 100 to 300 nA of KrF⁻ ions from a radial extraction Penning source operated on freshly synthesized KrF₂ gas. We have attempted to make KrF⁻ ions in a high intensity source using a titanium gas cathode fed with a mixture of krypton and sulfur hexafluoride. The hope was that KrF₂ might be made in the intense plasma that forms in the gas admittance hole, be gettered by the titanium, and then be sputtered to form KrF⁻ ions. Unfortunately, no currents > 1 nA were observed corresponding to KrF⁻. However, we are still optimistic about this approach and intend to pursue it further.

Reference

- 1) E. Minehara, S. Abe, T. Yoshida, Y. Sato, M. Kanda, C. Kobayashi, and S. Harashina, Nucl. Instr. and Methods 233 (1984) 217.

A Negative Ion Cookbook

³⁷Rubidium

Isotopes

⁸⁵Rb - 72.15%, ⁸⁷Rb - 27.85%

Physical Properties

E.A. = 0.486 eV, I.P. = 4.18 eV, m.p. = 38.9 °C, W.F. = 2.16 eV

Cathodes

The low melting point and reactivity of the metal prevent its use in a cathode and we have tried only rubidium carbonate (Rb₂CO₃, m.p. = 837 °C). Since the latter is deliquescent we have usually melted a small amount of the carbonate, forming a ball of clear bubbling liquid. Once the bubbling stops the ball is allowed to cool, immediately crushed, and loaded as quickly as possible into a cathode. It is thought that during heating the carbonate decomposes and interacts with the flame of the propane torch to form the hydroxide. Cathodes have been prepared with and without silver powder but we caution that unless it is a very dry day, mixing is best done in a dry box.

Performance

None of the cathodes performed particularly well and ⁸⁵Rb⁻ currents were typically only 0.15 to 0.25 μA. We have noticed that cathodes containing alkali metals, particularly the heavier ones, tend to run away, i.e. the cathode current slowly increases to 5 mA or more. This situation is best counteracted by reducing the cesium reservoir temperature. The addition of silver powder helps stability but usually at the expense of current.

If a prolonged study were planned with rubidium we would suggest a completely different approach. We have noticed that cathodes containing metallic aluminum and iron, when used in the spherical ionizer source, produce unusually intense beams of ¹³³Cs⁻ (~1 to 2 μA). It is likely that similar currents of ⁸⁵Rb⁻ might be obtained if rubidium is used in place of cesium -- see Cesium.

Molecular Ions

Overleaf is shown a negative ion spectrum obtained from a cathode containing melted rubidium carbonate. Clearly evident are the elemental ions and peaks corresponding to RbO⁻ and RbO₂⁻. No other rubidium molecular ions have been observed.

A Negative Ion Cookbook

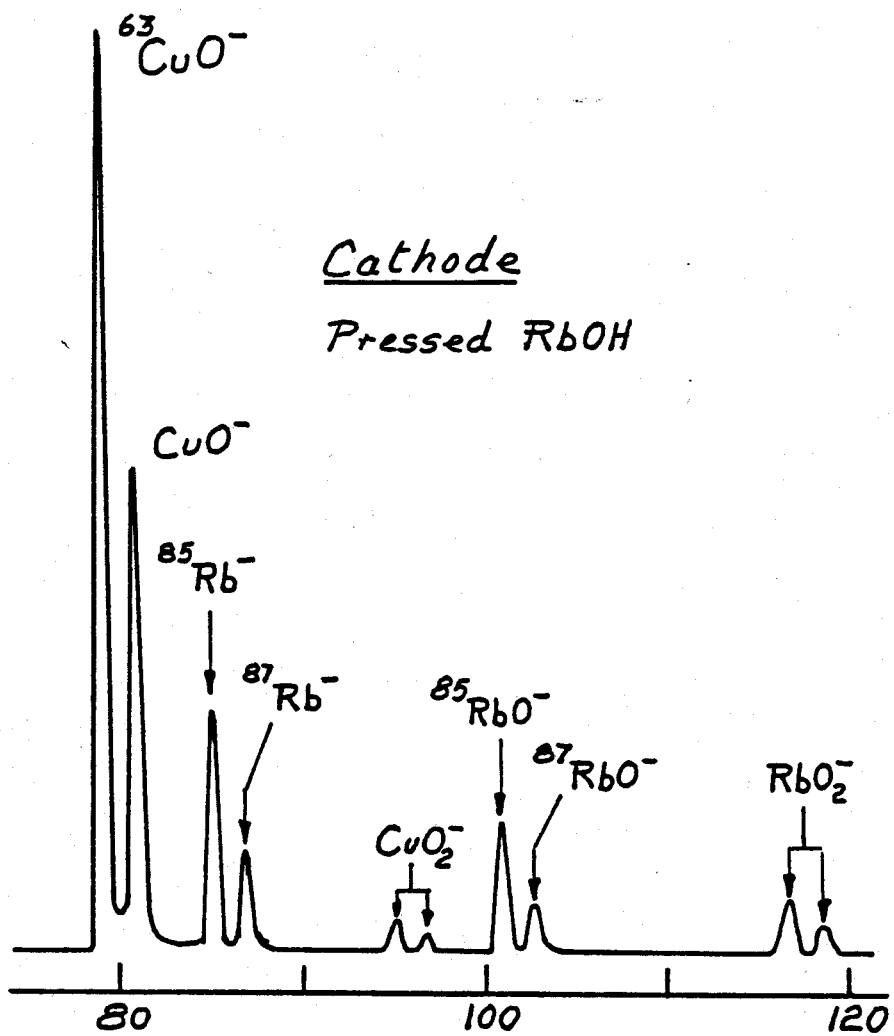

A spectrum obtained from a cathode containing melted rubidium carbonate. It is thought that during the heating the carbonate was converted to rubidium hydroxide. Performance was at best fair and $^{85}\text{Rb}^-$ currents were typically only 150 to 250 nA. Note the peaks corresponding to RbO^- and RbO_2^- .

A Negative Ion Cookbook

³⁸Strontium

Isotopes

⁸⁴Sr - 0.56%, ⁸⁶Sr - 9.86%, ⁸⁷Sr - 7.00%, ⁸⁸Sr - 82.58%

Physical Properties

E.A. < 0, I.P. = 5.69 eV, m.p. = 769 °C, W.F. = 2.59 eV

Cathodes

Strontium is similar to calcium, but unlike the former it is believed to have a negative electron affinity. Because of this we never tried the element in a cathode, but proceeded directly to the hydride. Strontium hydride (SrH₂, decomposes ~ 675 °C) resembles calcium hydride and is easy to make. We followed the procedure already described for making calcium hydride (see Calcium) and clearly saw the small piece of strontium metal glow brightly as it exothermically reacted with the hydrogen. The residue was a piece of gray brittle material and was more than sufficient to load two cathodes.

Performance

Since there is some danger of decomposing the hydride, the cathode voltage was increased slowly over a period of about 10 minutes to the usual value of 8 kV. ⁸⁸SrH₃⁻ was observed almost immediately and within 10 minutes the current was ~ 4 μA. The intensities of the peaks at m = 89, 90, and 91 were generally similar to those of calcium, but with the triple hydride 5 or 6 times stronger than the single hydride and the dihydride clearly very weak. A sample negative ion spectrum is shown overleaf.

The cathode performed very much like calcium hydride and ran smoothly and stably for over two hours, producing ⁸⁸SrH₃⁻ currents ranging from 3 to 5 μA.

Molecular Ions

In addition to the hydride beams, weak peaks were also observed corresponding to ⁸⁸SrO⁻ and probably ⁸⁸SrOH⁻. Although we never tried a cathode containing strontium oxide, we would guess from comparison with calcium that the oxide ion would not be prolific and probably about 1 μA.

A Negative Ion Cookbook

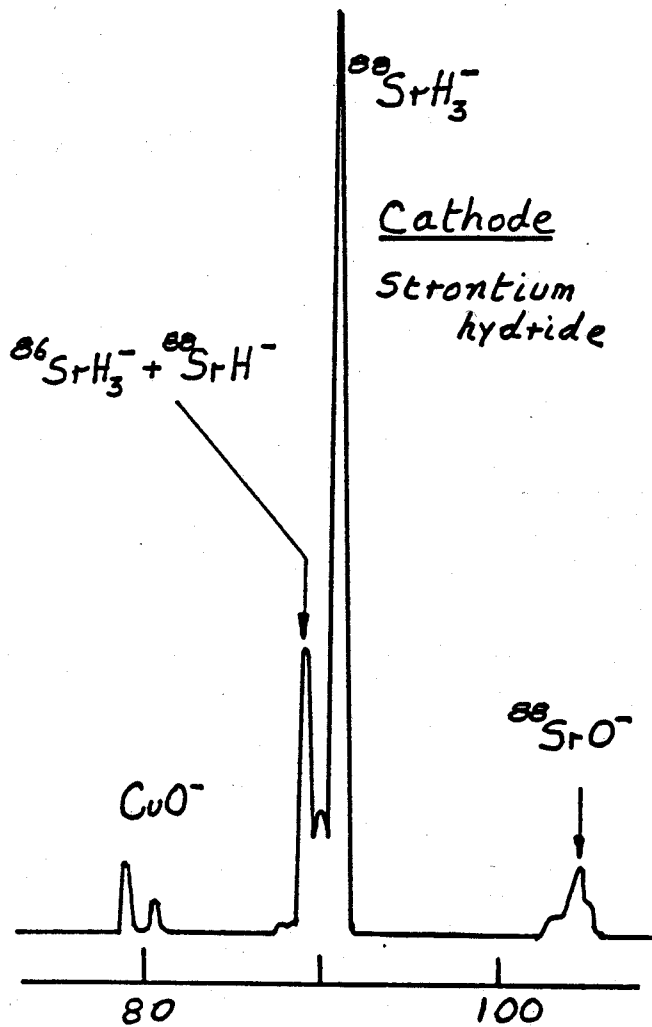

The negative ion spectrum of strontium hydride (SrH_2) is very similar to that of calcium hydride and clearly the dominant ion is $^{88}\text{SrH}_3^-$. The cathode ran very smoothly and produced between 3 and 5 μA of $^{88}\text{SrH}_3^-$ ions for over two hours.

A Negative Ion Cookbook

³⁹Yttrium

Isotopes

⁸⁹Y - 10070

Physical Properties

E.A. = 0.307 eV, I.P. = 6.38 eV, m.p. = 1522 °C, W.F. = 3.1 eV

Cathodes

Yttrium has proved a challenging negative ion and we have made measurements with several cathodes including elemental metal, commercially purchased and home prepared hydrides, a gas cathode with hydrogen, and a cathode with yttrium oxide. None was completely satisfactory, and we think the problem is that yttrium, like lanthanum and the rare earths, contaminates and impairs the operation of the cesium ionizer. All of these metals have high melting points, increasing the probability that sputtered atoms will stick to the ionizer, and all have low work functions. We presently have no solution to this problem other than frequent ionizer cleaning (by micro-blasting) and running the ionizer at a dangerously high temperature (~1350 °C).

The metal cathode did not perform particularly well, but it did establish the existence of a weak (~5 nA) elemental beam, several hydrides, a carbide, and an oxide. Since some of the hydrides, particularly the dihydride, were stronger than the elemental ion, it seemed likely that yttrium hydride might be a better cathode material.

Yttrium metal absorbs hydrogen like titanium and it is relatively simple to make the hydride (YH₂) by heating the metal in an atmosphere of hydrogen. We used the same apparatus and followed the procedure previously described for making calcium hydride (see Calcium). The hydride is commercially available and we have also used this in cathodes. Shown overleaf is a typical negative spectrum obtained with an yttrium hydride cathode. Clearly evident are peaks corresponding to four hydrides; the most intense are ⁸⁹YH₂⁻, and ⁸⁹YH₄⁻. Usually the ⁸⁹YH₂⁻ current, which was largest from solid hydride cathodes, was disappointingly small and typically 0.1 to 0.2 μA. Unlike the negative ion current from most cathodes, the ⁸⁹YH₂⁻ current failed to increase with time. Since the cathode current fell at the same time it seems likely that ionizer contamination was responsible for the lack of growth. Also shown overleaf is a spectrum obtained with an yttrium metal gas cathode (see inset sketch) and hydrogen gas. For some reason this performed much better than the solid hydrides and we maintained between 1 and 2 μA of ⁸⁹YH₂⁻ and ⁸⁹YH₄⁻ for over two hours. Performance was as if the presence of hydrogen reduced or slowed down ionizer poisoning.

An yttrium oxide cathode, containing no silver, ran smoothly but with slowly declining output and cathode current for over two hours. The ⁸⁹YO⁻ current fell during this period from 1.2 to 0.8 μA.

Recommended Cathode

We are unsure. The best performance was with the gas cathode and hydrogen, producing 1 to 2 μA of ⁸⁹YH₂⁻ and ⁸⁹YH₄⁻. However, the oxide cathode did not perform too badly and it is more convenient to use.

Molecular Ions

Yttrium quite definitely forms a stable negative ion but it is very weak and we never looked for a dimer. Like lanthanum and most of the rare earths, it forms four hydrides, YH⁻, YH₂⁻, YH₃⁻, and YH₄⁻, with the even hydrides significantly stronger than the odd ones. Both the metal and hydride cathodes showed the carbides YC⁻ and YC₂⁻, the oxides YO⁻ and YO₂⁻, and possibly a hydroxide ion. The ratio of YO⁻ to YO₂⁻ from the oxide cathode was about 10 to 1.

A Negative Ion Cookbook

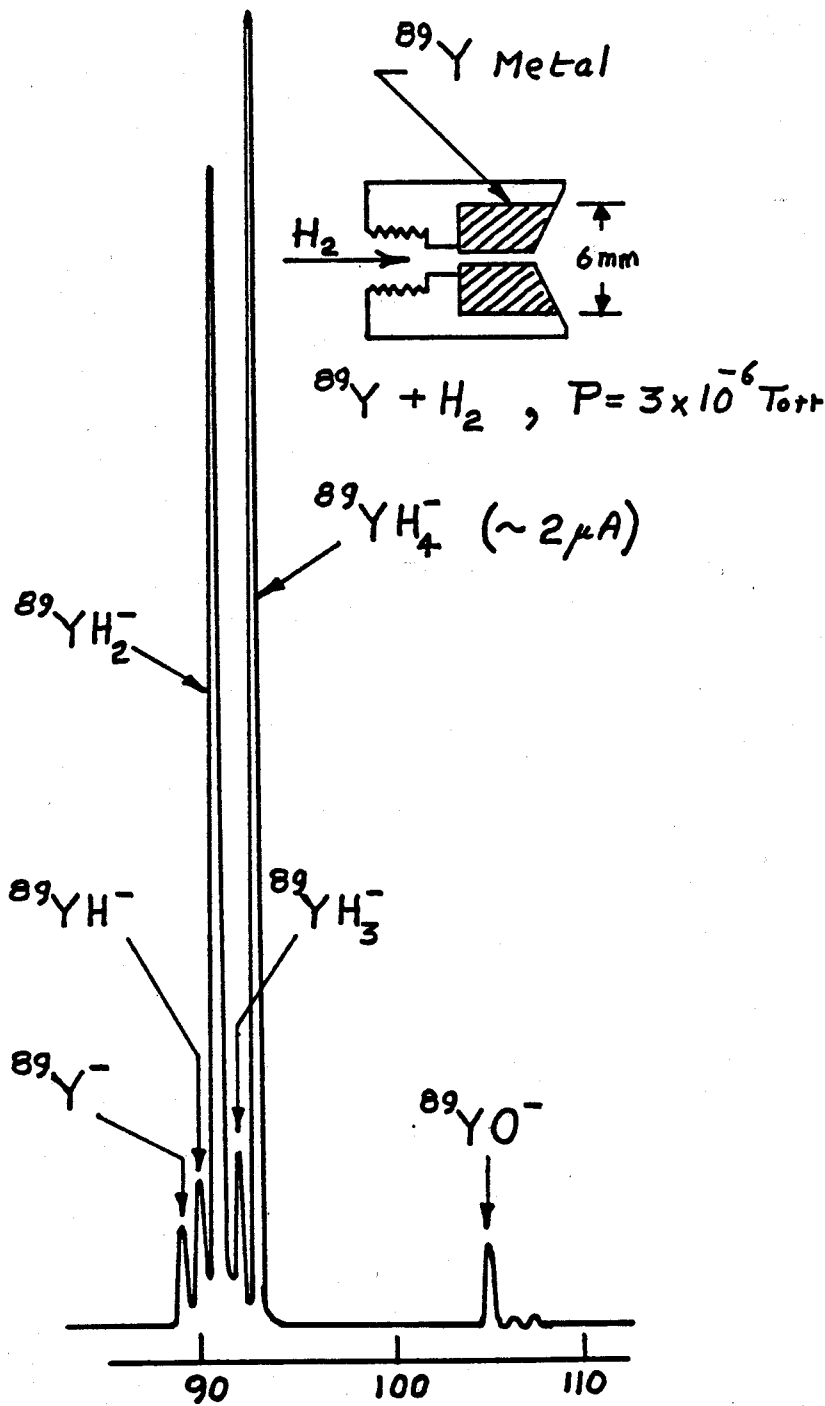

Part of a negative ion spectrum obtained with the gas cathode shown sketched above. For reasons which we do not understand the gas cathode performed much better than a cathode containing yttrium hydride, and for over two hours we had 1 to 2 μA of $^{89}\text{YH}_2^-$ and $^{89}\text{YH}_4^-$.

A Negative Ion Cookbook

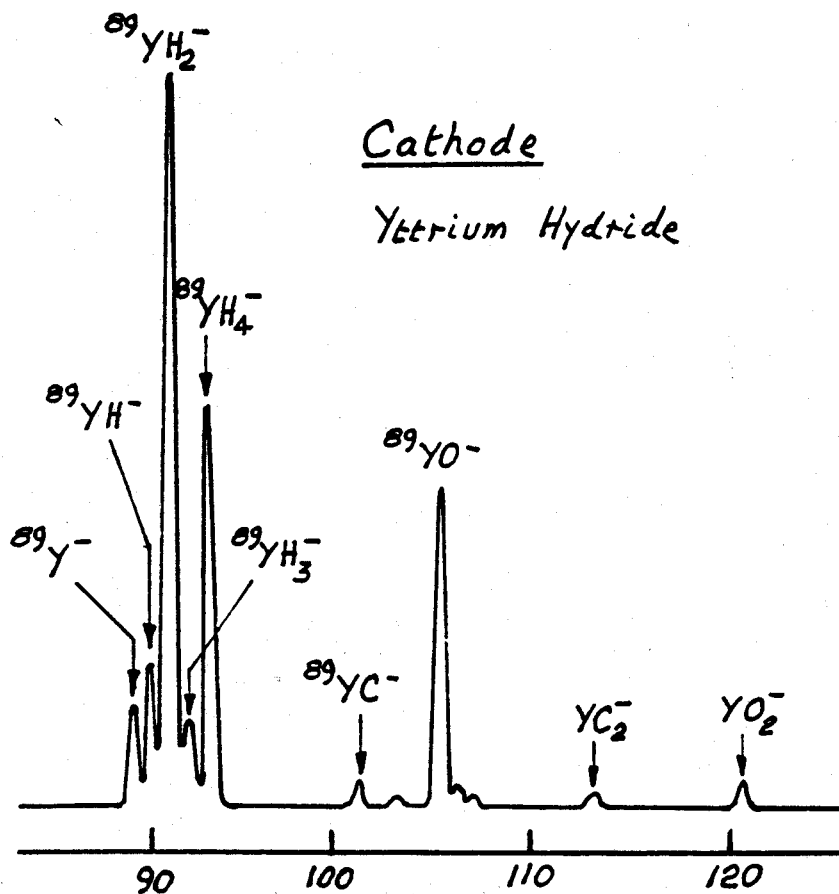

The spectrum shown above was obtained with a cathode containing yttrium hydride (YH_2). Although the shape of the spectrum generally resembles that obtained with a gas cathode, currents were much less and typically 0.1 to 0.2 μA of $^{89}\text{YH}_2^-$. We believe that yttrium metal was sticking on the cesium ionizer, reducing its work function and its ionization efficiency.

A Negative Ion Cookbook

⁴⁰Zirconium

Isotopes

⁹⁰Zr - 51.45%, ⁹¹Zr - 11.27%, ⁹²Zr - 17.17%, ⁹⁴Zr - 17.33%, ⁹⁶Zr - 2.78%

Physical Properties

E.A. = 0.426 eV, I.P. = 6.84 eV, m.p. = 1852 °C, W.F. = 4.05 eV

Cathodes

Since zirconium is in the same sub-group as titanium and is expected to behave similarly, we tried only cathodes made from zirconium rod and from zirconium powder loaded with hydrogen. The elemental cathode ran extremely well but produced small currents, typically 0.1 to 0.2 μA of ⁹⁰Zr⁻. Rather surprisingly, the elemental currents closely reflect the isotopic composition of zirconium, indicating an unusually small hydride presence (see spectrum over-leaf).

The zirconium hydride was made by heating 80 mesh zirconium powder in 600 Torr of hydrogen, using the apparatus described previously for making calcium hydride (see Calcium). At a temperature of about 400 to 500 °C the zirconium powder visibly glowed, indicating the exothermic absorption of hydrogen, presumably forming ZrH₂. The hydride loads well and when hammered into a cathode looks quite metallic. It also performs well in the source, usually producing almost instantaneously 30 μA of H⁻ rising to over 100 μA after 90 minutes. The ⁹⁰ZrH⁻ current behaves similarly, usually starting around 2 μA and rising to about 5 μA . It is evident from the spectrum shown overleaf that zirconium has several hydrides.

Recommended Cathode

Although elemental cathodes perform well, the ⁹⁰Zr⁻ current is small (0.1 to 0.2 μA), and a better choice is almost certainly the hydride. This also performs well and can be relied on to produce 2 or 3 μA of ⁹⁰ZrH⁻ for several hours.

Molecular Ions

As remarked earlier, zirconium forms several hydrides, including ZrH⁻, ZrH₂⁻, ZrH₃⁻, and ZrH₄⁻, with intensities roughly in the ratio 3.8:2.8:2.3:1. The only other molecular ion that we have observed is the oxide. Zirconium probably forms a dimer ion, like titanium, but unfortunately we did not look for it.

A Negative Ion Cookbook

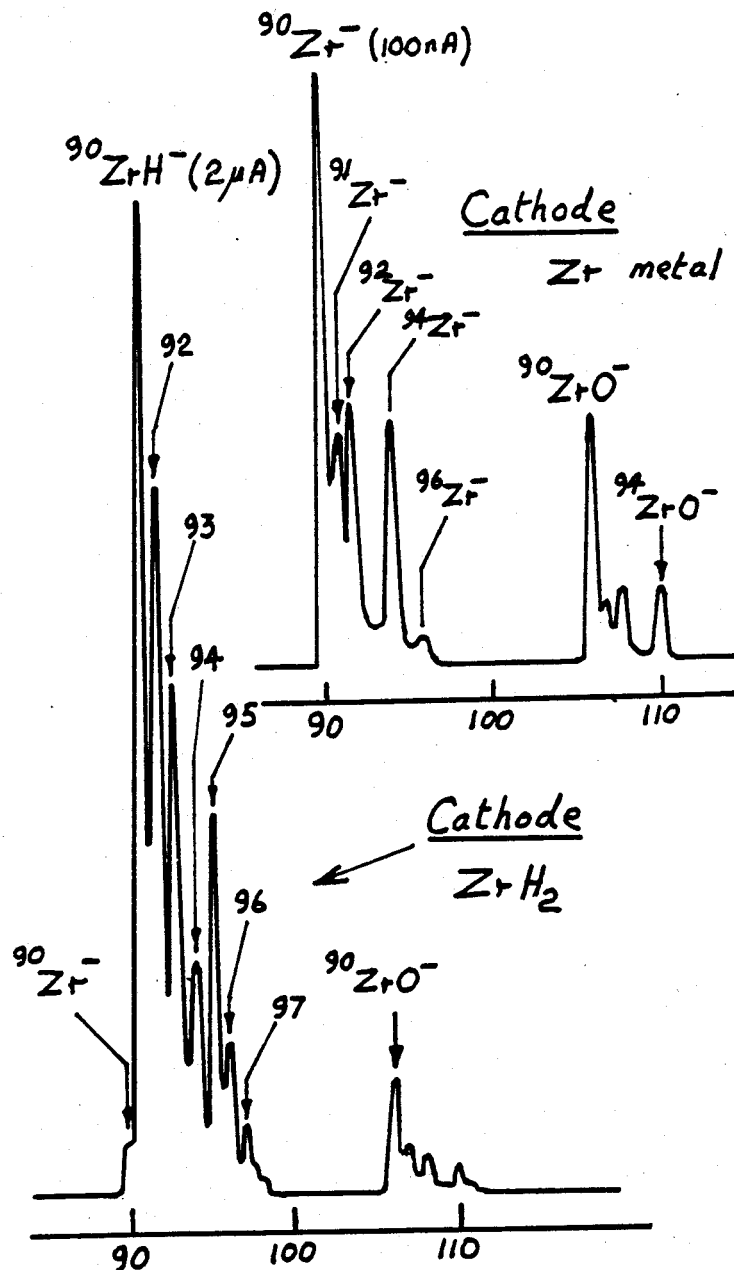

The upper spectrum was obtained with a cathode containing an insert of 5 mm diameter zirconium rod. Clearly evident are the elemental ions with almost the correct isotopic composition indicating unusually low hydrogen content. $^{90}\text{Zr}^-$ currents were typically 0.1 to 0.2 μA . The lower spectrum shows the more intense (and complex) spectrum obtained from a cathode containing zirconium hydride (ZrH_2). Careful analysis shows that zirconium has at least 4 hydrides, ZrH^- , ZrH_2^- , ZrH_3^- , and ZrH_4^- .

A Negative Ion Cookbook

⁴¹Niobium

Isotopes

⁹³Nb - 100%

Physical Properties

E.A. = 0.893 eV, I.P. = 6.88 eV, m.p. = 2468 °C, W.F. = 4.3 eV

Cathodes

Two kinds of cathodes have been tried, elemental and a mixture of niobium powder and graphite filings. The elemental cathode was made by pressing 5 mm diameter rod into a copper cathode. Unfortunately the cathode was not pre-drilled and the negative ion current rose extremely slowly. The initial elemental current was only 0.2 μA and was accompanied by at least 3 hydrides. However, at the end of an hour, the elemental current had grown to 1 μA and the hydrides had all but disappeared. The cathode was operated for a further two hours during which time the current rose and leveled around 2.5 μA . Although performance was adequate, we were disappointed to obtain only 2.5 μA from a metallic element with an electron affinity of almost 0.9 eV.

The cathode containing a mixture (roughly 1:1 by volume) of niobium powder and graphite powder performed extremely well and within a few minutes was producing 2.5 μA of NbC^- ions. This cathode was run for 4.5 hours, much of the time with a current of 6 μA . Overleaf is shown a negative ion spectrum measured shortly after the cathode had been placed in the source.

Recommended Cathode

Since the loss in final energy increased by accelerating NbC^- rather than Nb^- is small, we recommend using a niobium-graphite powder cathode. These are extremely easy to prepare, produce an excellent current almost immediately, run steadily and last for several hours. If the elemental ion must be used, pre-drill the cathode.

Molecular Ions

Niobium forms a fairly intense dimer negative ion and with an elemental current of 1 μA we observed about 0.3 μA of the dimer. Like vanadium and tantalum, niobium forms several hydrides and we positively identified NbH^- , NbH_2^- , and NbH_3^- from the elemental cathode shortly after it was introduced into the source. It is likely that microampere currents of these can be obtained either from a gas cathode or one prepared by absorbing hydrogen in niobium. Also, like vanadium and tantalum it forms intense carbide beams, with NbC^- stronger than NbC_2^- . These are shown in the spectrum overleaf where a weak peak of NbO^- is also observed. Although we have never tried a cathode containing niobium oxide, NbO^- is likely to be intense.

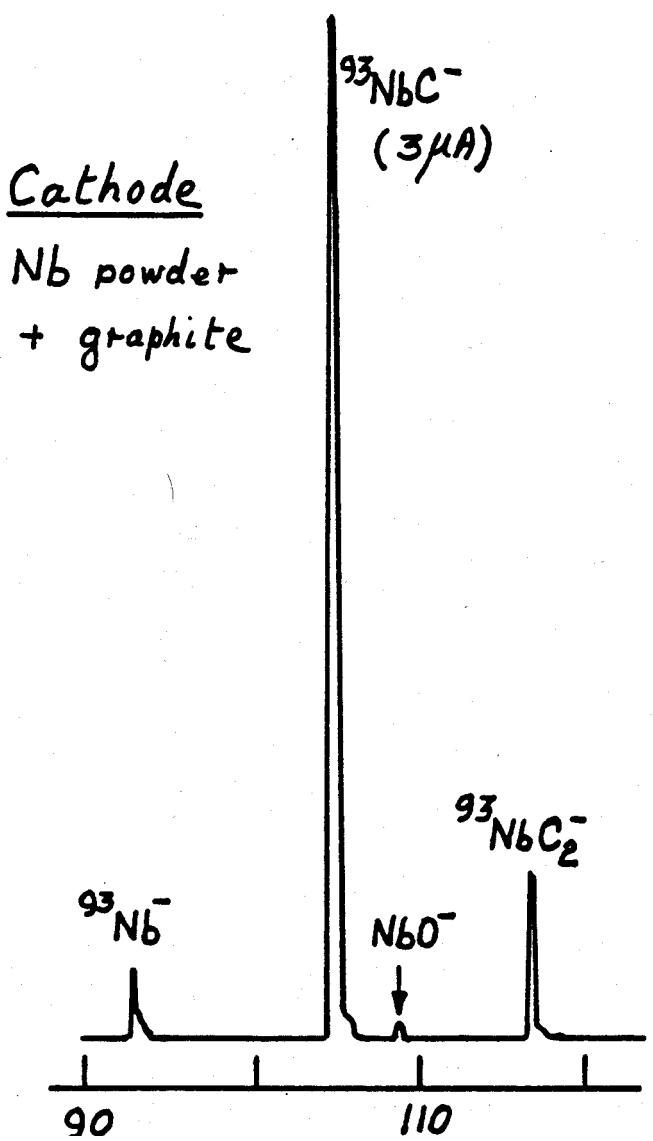

Niobium, like vanadium and tantalum, forms a fairly intense carbide beam ($^{93}\text{NbC}^-$). The cathodes, made from a mixture of niobium powder and graphite filings, are easy to make, perform well, and last for several hours.

A Negative Ion Cookbook

⁴²Molybdenum

Isotopes

⁹²Mo - 14.84%, ⁹⁴Mo - 9.25%, ⁹⁵Mo - 15.92%, ⁹⁶Mo - 9.55%, ⁹⁸Mo - 24.13%, ¹⁰⁰Mo - 9.63%

Physical Properties

E.A. = 0.746 eV, I.P. = 7.10 eV, m.p. = 2617 °C, W.F. = 4.6 eV

Cathodes

Measurements have been made with cathodes containing the metal, molybdenum powder mixed with powdered graphite, molybdenum trioxide (MoO₃, m.p. = 795 °C) and with a metal cathode and oxygen gas.

The metal cathode, made from 6 mm diameter rod, performed reasonably well but the currents were disappointingly small, particularly in view of molybdenum's electron affinity of almost 0.75 eV. Even when pre-drilled the initial current of ⁹²Mo⁻ was only about 20 nA and after 2 hours rarely exceeded 200 nA. A typical negative ion spectrum from a pre-drilled cathode is shown overleaf.

Measurements made with a cathode containing a mixture of molybdenum and graphite powders were a disappointment and amidst a profusion of peaks we were fortunate to identify a weak peak corresponding to ⁹²MoC⁻. A cathode containing molybdenum trioxide performed much better and clusters of peaks were identified corresponding to four oxides -- an unusually large number. However, it ran unsteadily and a second cathode was prepared mixed with copper powder (this was used in preference to silver to minimize interference with the oxides of molybdenum). This performed better and a negative ion spectrum obtained with it is shown on the next page. Noteworthy are the absence of elemental ions and the four fairly intense clusters of peaks corresponding to MoO⁻, MoO₂⁻, MoO₃⁻, and MoO₄⁻. The ⁹²Mo oxide currents corresponding to these were typically 140, 530, 830 and 100 nA respectively. Measurements with an elemental cathode and oxygen gas produced smaller oxide currents, but the single oxide was usually strongest (⁹²MoO⁻ ~ 100 nA). If an oxide is to be accelerated it probably is best to use a solid cathode, and in light of the above, one containing a lower order oxide such as molybdenum dioxide to favor the intensity of MoO⁻ or MoO₂⁻.

Recommended Cathode

Although there are pros and cons we favor the elemental cathode. Admittedly currents are not large, but the spectrum is clean (free from hydrides), and molybdenum sputters slowly and cathode lifetime is expected to be 5 or more hours.

Molecular Ions

The intensities of the elemental ion peaks correspond very closely to their isotopic abundancies, leaving little room for hydrides. Although we have no evidence for the existence of hydrides, they almost certainly exist and it is unfortunate that while working with a gas cathode we did not use hydrogen. In contrast with the oxides, the carbides of molybdenum are very weak and we had difficulty in observing ⁹²MoC⁻. Molybdenum is unusual in that it has four strong oxides, MoO⁻, MoO₂⁻, MoO₃⁻, and MoO₄⁻.

A Negative Ion Cookbook

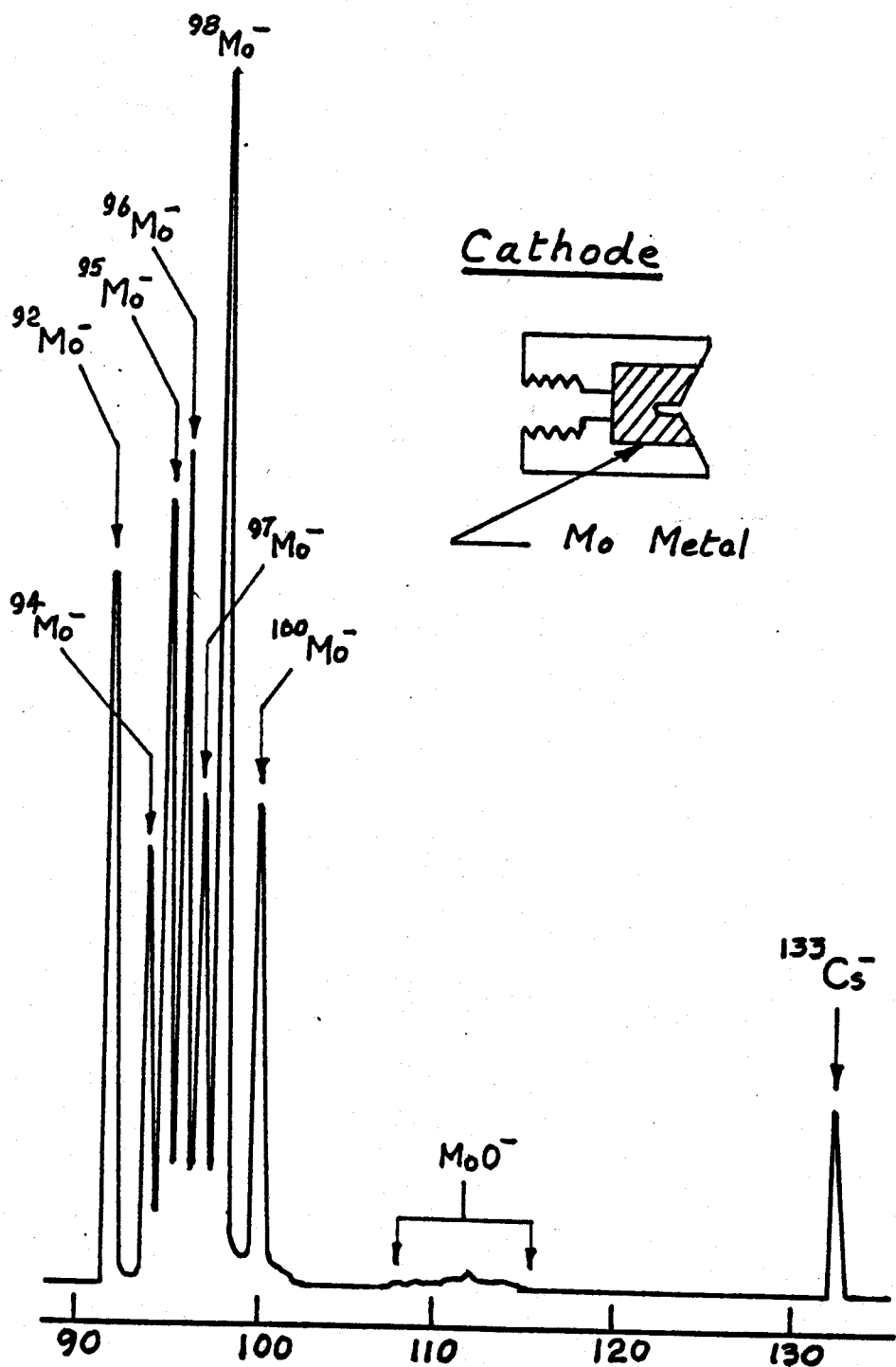

A negative ion spectrum obtained with a pre-drilled cathode made from an insert of 6 mm diameter molybdenum rod. Even though pre-drilled the $^{92}\text{Mo}^-$ current usually begins around 20 nA and rises fairly rapidly to about 100 nA, but rarely exceeds 200 nA. The spectrum is remarkably clean, providing no evidence for the existence of hydrides, the merest trace of an oxide, and a weak peak (~ 30 nA) corresponding to $^{133}\text{Cs}^-$. The intensity of the latter is typical of most metal cathodes but very much less than observed with aluminum and iron.

A Negative Ion Cookbook

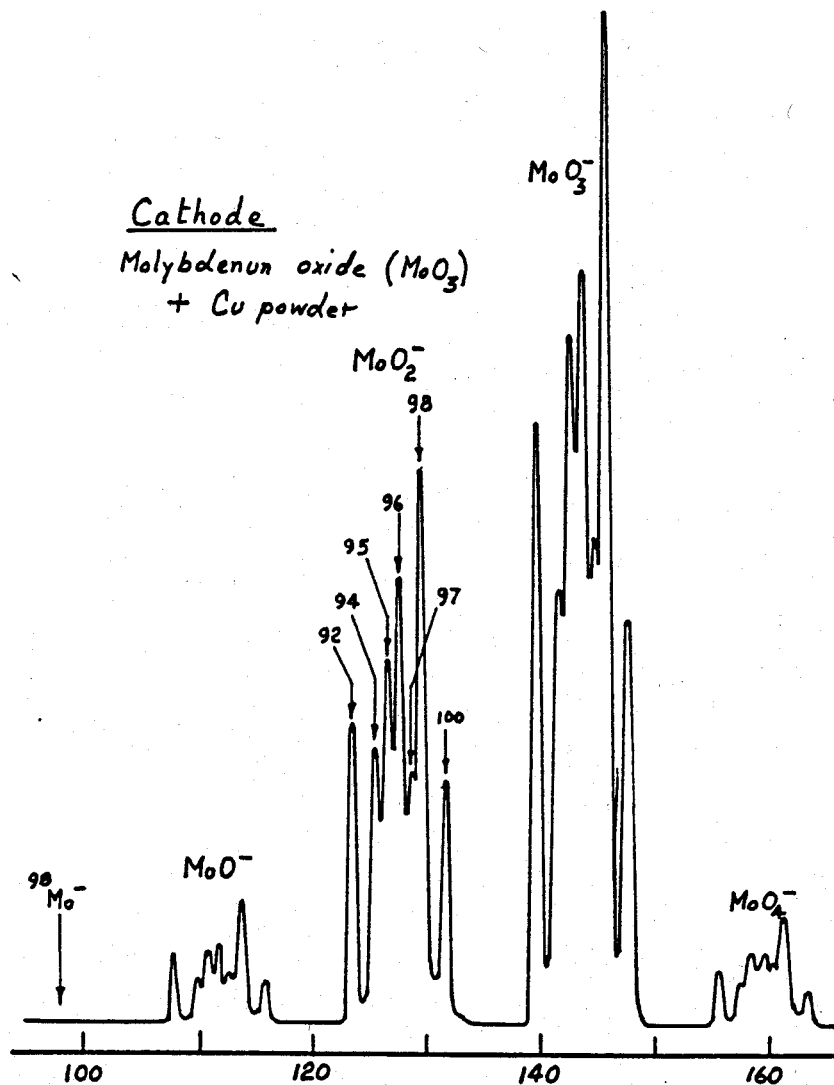

A spectrum obtained with a cathode containing molybdenum trioxide (MoO_3) showing clusters of peaks corresponding to 4 oxides. The trioxide was used because it was available, and a better choice may be the dioxide. The latter may favor the formation of MoO^- and MoO_2^- , which are better for acceleration in a tandem.

A Negative Ion Cookbook

⁴³Technetium

Isotopes

All of the technetium isotopes are radioactive, but ⁹⁷Tc and ⁹⁸Tc have half-lives of 2.6 and 4.2x10⁶ years respectively, and the former decays 100% by internal conversion. ⁹⁹Tc has a half-life of 2.1x10⁵ years.

Physical Properties

E.A. = 0.55 eV, I.P. = 7.28 eV, m.p. = 2172 °C, W.F. = ?

Cathodes

Due to its radioactivity and a lack of demand we have made no measurements with technetium. However, the metal is readily available and since its properties resemble those of rhenium and it has a higher electron affinity, negative ion currents in the 100 to 500 nA range should present no difficulty. The radioactivity would probably require the use of a dedicated source similar to those used for tritium and ¹⁴C.

A Negative Ion Cookbook

44Ruthenium

Isotopes

⁹⁶Ru - 5.52%, ⁹⁸Ru - 1.88%, ¹⁰⁰Ru - 12.6%, ¹⁰¹Ru - 17.0%, ¹⁰²Ru - 31.6%, ¹⁰⁴Ru - 18.7%

Physical Properties

E.A. = 1.05 eV, I.P. = 7.36 eV, m.p. = 2310 °C, W.F. = 4.71 eV

Cathodes

We have studied ruthenium on two separate occasions and on both the cathodes were prepared by tamping ruthenium metal powder into standard cathodes, but the powders came from different suppliers. The two performed very differently with one giving ten times the current of the other. We are at a loss as to why. On both occasions the source seemed to be functioning properly and neither powder appeared heavily oxidized or to be otherwise contaminated. Since the large currents are more consistent with the 1.05 eV electron affinity of ruthenium, we report here only the results of those measurements.

Performance

The current from the powder cathode rose quickly; within 30 minutes there was ~ 1 μA of ¹⁰²Ru⁻ and by the end of an hour over 3 μA. These currents were measured with the analyzing slits at ±1.25 mm to resolve the isotopes and the true current was at least twice that measured. The cathode ran exceptionally steadily for about 4 hours before the current began a gradual decline from its maximum of about 4 μA. Overleaf is shown a negative ion spectrum measured with this cathode.

Molecular Ions

Like so many elements, ruthenium forms a rather weak dimer ion, and the Ru₂⁻ current was about 20% that of the elemental ion. The intensities of the peaks in the spectrum shown overleaf match closely the isotopic abundancies, and if hydrides are present they are barely discernable. Other than the dimer, the only molecular ion that we saw with reasonable certainty was the oxide (initially this was much stronger than shown in the spectrum).

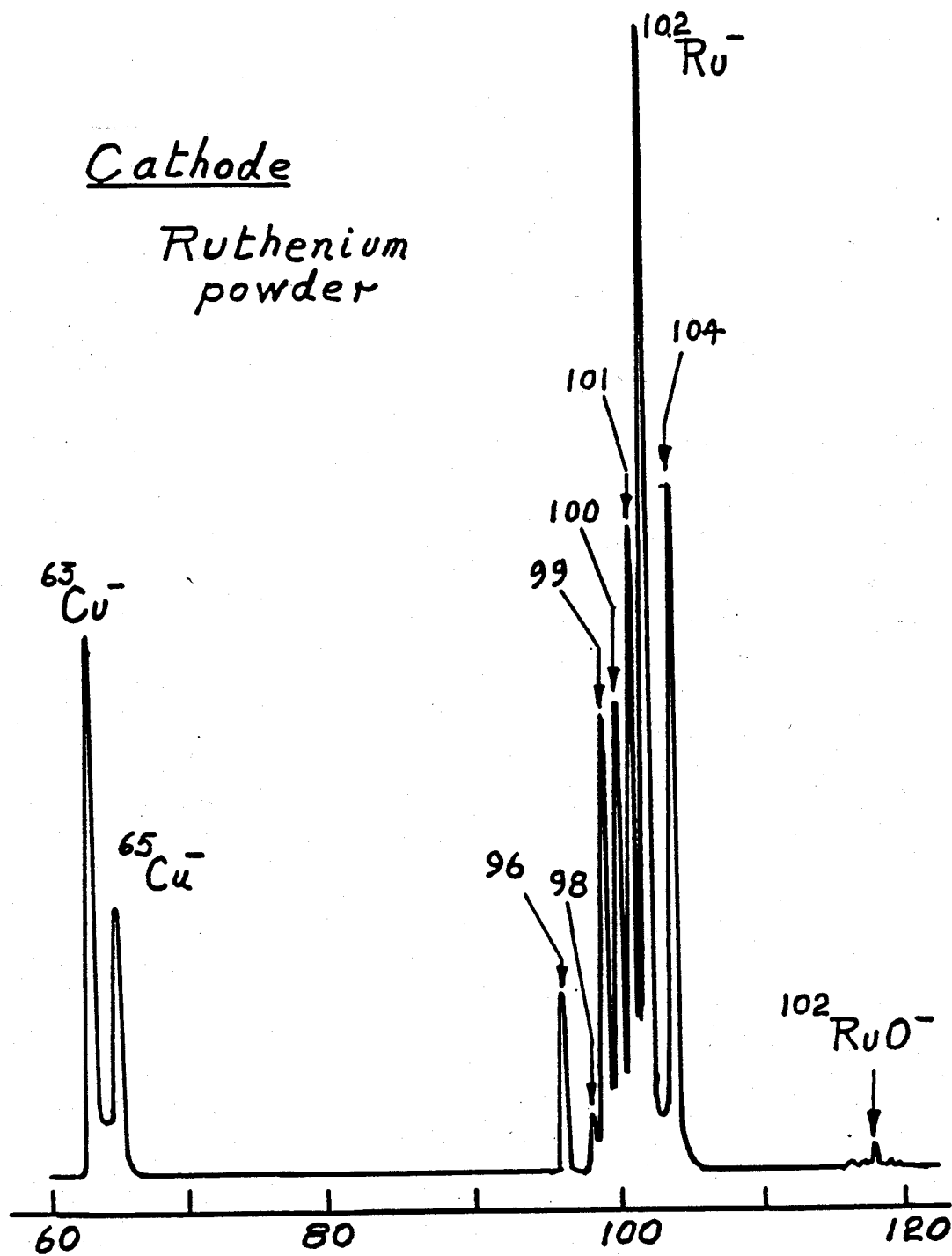

A negative ion spectrum from a standard cathode loaded with 80 mesh ruthenium metal powder. Ruthenium forms a fairly prolific negative ion and for much of the time the $^{102}Ru^-$ current was $> 2 \mu A$ measured through analyzing slits adjusted to $\pm 1.25 \text{ mm}$ (causing a current attenuation of at least a factor of two).

A Negative Ion Cookbook

⁴⁵Rhodium

Isotopes

¹⁰³Rh - 100%

Physical Properties

E.A. = 1.137 eV, I.P. = 7.46 eV, m.p. = 1966 °C, W.F. = 4.98 eV

Cathodes

The only cathodes that we have used were made by tamping 60 mesh rhodium powder into a 1.6 mm diameter hole in a standard cathode. The powder pressed well and after hammering looked like a piece of fused metal.

Performance

Since the cathodes were not pre-drilled (this is difficult to do with pressed powder) the current tended to rise slowly from its initial value of 2.5 μ A to a maximum of 12 μ A after about 3 hours. The three cathodes that we tested all ran smoothly and lasted for a little over 4 hours. Since compressed powders usually sputter faster than fused metal we usually drilled the 1.6 mm diameter hole in, the cathode 4 mm deep. Overleaf is shown a negative ion spectrum.

Molecular Ions

The only molecular beams observed were ¹⁰³RhO⁻, which was quite weak, and the dimer (Rh₂⁻). The current of the latter was typically one quarter that of the elemental ion.

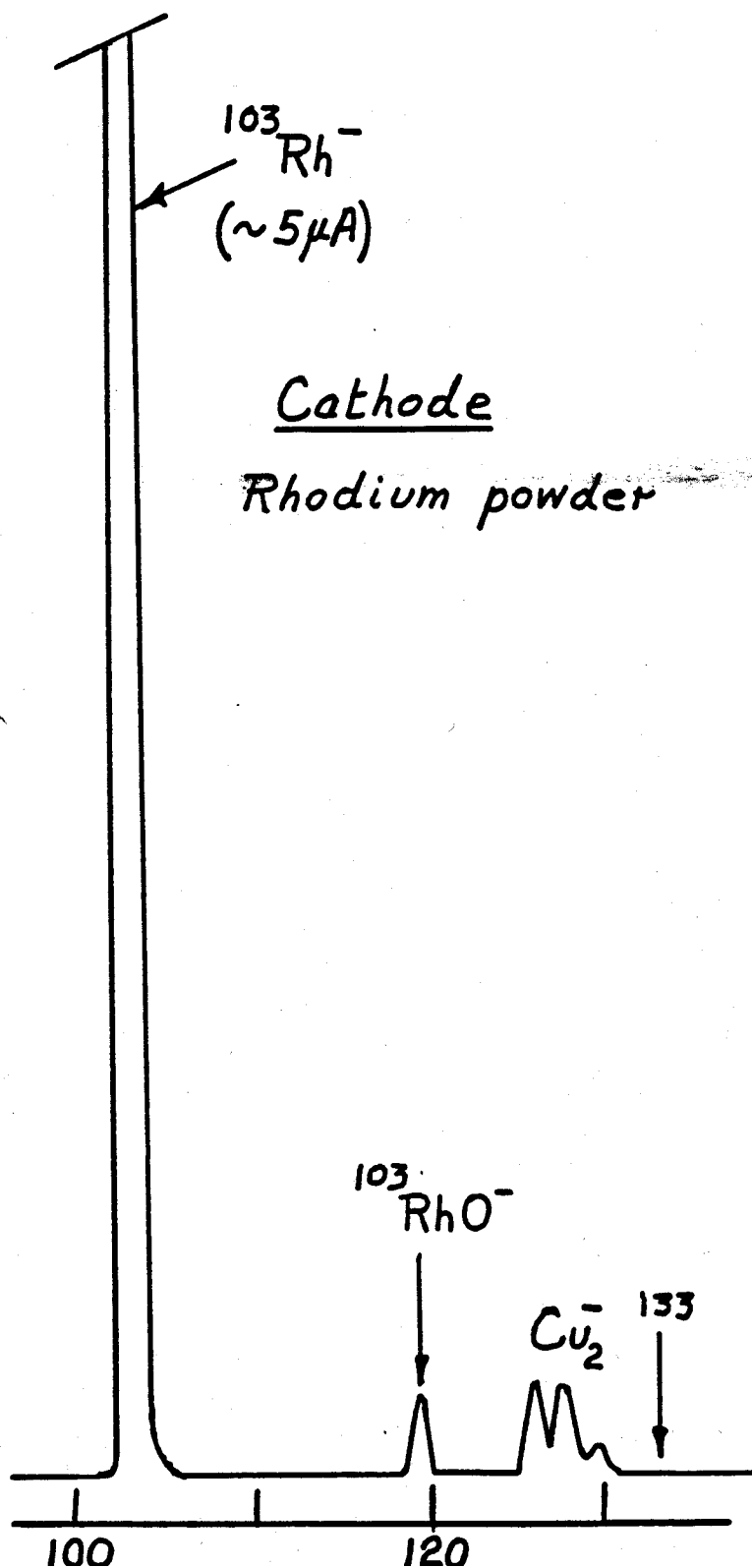

A negative ion spectrum measured with a standard cathode loaded , with 60 mesh rhodium metal powder. As might be expected for an element with an electron affinity of almost 1.14 eV, the elemental current was typically about 10 μA .

A Negative Ion Cookbook

⁴⁶Palladium

Isotopes

¹⁰²Pd - 1.02%, ¹⁰⁴Pd - 11.14%, ¹⁰⁵Pd - 22.33%, ¹⁰⁶Pd - 27.33%, ¹⁰⁸Pd - 26.46%, ¹¹⁰Pd - 11.72%

Physical Properties

E.A. = 0.557 eV, I.P. = 8.33 eV, m.p. = 1554 °C, W.F. = 5.12 eV

Cathodes

Our first cathode was made by pressing 60 mesh palladium powder into a 1.6 mm diameter hole in a standard cathode. It performed poorly and not only were the elemental currents small but identification was complicated by the presence of at least one hydride. Also evident in the spectrum were fairly strong clusters of peaks corresponding to PdO⁻ and PdO₂⁻ and an unusually strong cluster corresponding to PdCu⁻.

A second cathode was prepared by pressing the same powder into a 2.5 mm diameter by 5 mm deep hole in a copper cathode. After the powder had been compacted a 1 mm diameter hole was drilled 1.5 mm deep into the powder (see sketch overleaf). This performed much better and after about 40 minutes the hydride presence had all but disappeared and the intensities of the elemental peaks closely matched the isotopic composition of palladium. The ¹⁰⁸Pd⁻ current was typically 0.7 μA measured through a slit opening of ± 1.25 mm (this attenuates the current by a factor of 2 to 2.5). Like most compressed powder cathodes the sputter rate was high and cathode lifetime was only 3 to 4 hours. A spectrum obtained with this cathode is shown overleaf.

A palladium gas cathode was made as described above but the 1 mm diameter hole was drilled completely through the cathode. This was used with ammonia, which to our surprise produced no measurable hydride currents but caused the elemental currents to almost double. (We are quite sure that we were observing elemental ions and not hydrides, and a similar but smaller increase was observed under similar circumstances with copper).

Molecular Ions

Palladium forms a relatively strong dimer ion with almost the same intensity as the elemental ion. As mentioned above, the first cathode showed clear evidence for at least one hydride, but we were unable to make them with a gas cathode and ammonia -- unfortunately we never tried hydrogen. All spectra showed moderately intense oxides, and clusters of peaks corresponding to PdO⁻ and PdO₂⁻ are clearly evident in the spectrum shown overleaf. However, this spectrum contains some additional peaks around mass 120 which we were unable to identify. As already mentioned, palladium formed an unusually intense beam of PdCu⁻ ions.

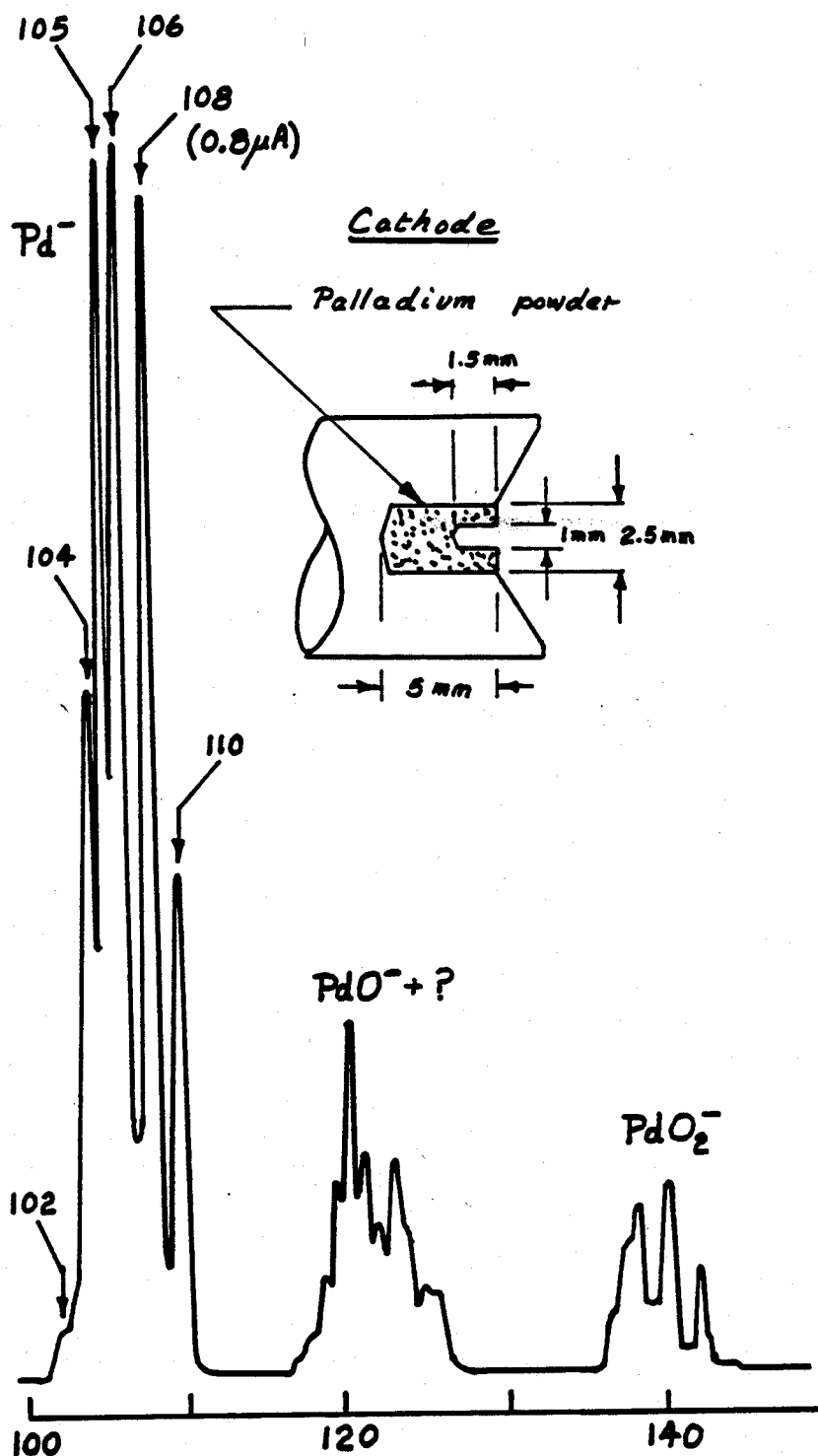

A negative ion spectrum measured with the type of cathode shown in the inset sketch. This was measured after about 1 hour of running and the hydride presence has almost completely disappeared. The relatively strong peak at mass 120 is probably not due to PdO⁻ but we are unable to identify it.

A Negative Ion Cookbook

47Silver

Isotopes

^{107}Ag - 51.82%, ^{109}Ag - 48.18%

Physical Properties

E.A. = 1.302 eV, I.P. = 7.57 eV, m.p. = 962 °C, W.F. = 4.26 eV

Cathodes

Silver is a very prolific negative ion and since excellent currents are obtained from metallic cathodes we have not experimented with alternatives. Usually the silver on hand in our laboratory is powder and we make cathodes either by melting the powder or pressing it directly into a 1.6 mm diameter hole in a copper cathode. Fused metal cathodes perform best, particularly if pre-drilled, but they are more troublesome to make and generally less convenient. Typical currents of either isotope are in the range 20 to 50 μA .

Recently we performed some tests with a cathode prepared by tamping silver powder into a 1.6 mm by 5 mm. deep hole in a standard copper cathode. Like most cathodes which have not been pre-drilled, the negative current climbed slowly at first and took almost 1 hour to reach 12 μA .

Thereafter the current rose fairly rapidly and within 2 hours exceeded 30 μA . Unfortunately, silver does sputter rapidly, particularly compressed powder, and the output fell dramatically after 3 hours. A typical negative ion spectrum, recorded around the halfway mark, is shown overleaf.

Molecular Ions

Most spectra showed few molecular ions with the exception of the dimer (Ag_2^-). The intensity of the latter, like many other dimers, is variable and appears to depend upon the depth of the sputter crater. With the compressed powder cathodes described above, the dimer to elemental ion ratio started around 25% and gradually fell to less than 5%. We observed no hydrides of silver and only occasionally a weak oxide, AgO^- .

A Negative Ion Cookbook

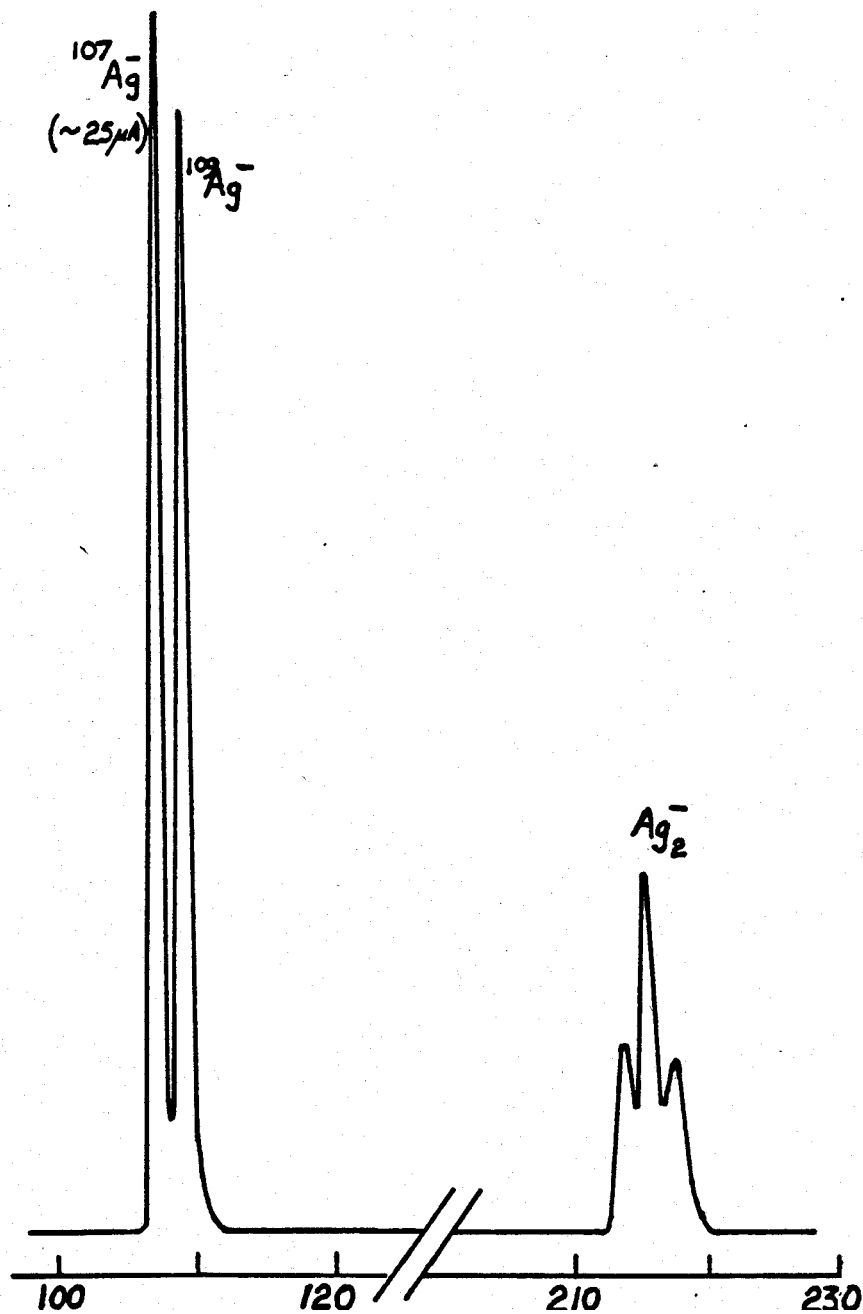

Silver is a prolific negative ion and elemental cathodes, made from compressed powder or bar stock, usually produce 20 to 30 μA of either isotope. The spectrum shown here was obtained from a cathode containing compressed powder after about 80 minutes of operation. Interestingly, the dimer to elemental ion ratio fell over a period of 3 hours from 25 to $< 5\%$.

A Negative Ion Cookbook

48Cadmium

Isotopes

¹⁰⁶Cd - 1.25%, ¹⁰⁸Cd - 0.89%, ¹¹⁰Cd - 12.49%, ¹¹¹Cd - 12.80%, ¹¹²Cd - 24.13%, ¹¹³Cd - 12.22%,
¹¹⁴Cd - 28.73%, ¹¹⁶Cd - 7.49%

Physical Properties

E.A. < 0, I.P. = 8.99 eV, m.p. = 321 °C, W.F. = 4.22 eV

Cathodes

Measurements have been made with cathodes containing cadmium metal, cadmium selenide (CdSe, m.p. - 1300 °C), cadmium oxide (CdO, m.p. - 1400 °C), and a cadmium metal gas cathode with oxygen. None provided the slightest evidence for an elemental negative ion and we think it likely that cadmium, like zinc, has a negative electron affinity.

A cathode containing cadmium oxide performed excellently during the first 5 or 10 minutes producing currents of ¹¹⁴CdO⁻ of over 1 μA. However, the current soon began to fall and within 30 minutes was reduced to 0.6 μA falling to 0.3 μA within the hour. Removal of the cathode revealed that cadmium oxide, like the metal, sputters remarkably quickly and the 3.5 mm thick oxide layer was almost completely sputtered through. This is very unusual behavior for an oxide.

The gas cathode was prepared by hammering cadmium metal into a 3 mm diameter by 6 mm deep hole in a copper cathode, and then drilling a 0.8 mm diameter gas admittance hole through the entire cathode (see inset sketch). This performed significantly better than the solid oxide cathode and with a relatively modest gas flow (the oxygen partial pressure in the source was ~ 4X10⁻⁷ Torr) the ¹¹⁴CdO⁻ current was 2 μA. This current, which was measured through a slit opening of ± 1.25 mm, was maintained very nearly constant for 3 hours. However, when the cathode was removed it was quite evident that it was heavily sputtered and the current could not have been maintained much longer. A negative ion spectrum is overleaf.

The cadmium selenide cathode produced excellent selenium currents (see Selenium) but no cadmium or identifiable molecular ions of cadmium.

Molecular Ions

Usually most metals contain appreciable amounts of hydrogen and even if the elemental ion is weak we usually observe one or more hydrides. With cadmium we observed neither and perhaps on a future occasion we will try hydrogen or ammonia with a gas cathode. Like most elements with negative electron affinity, cadmium does not appear to form a dimer ion, at least with an intensity > 1 nA.

As is evident from the spectrum obtained with the gas cathode, cadmium forms two negative oxides, CdO⁻ and CdO₂⁻ -- the former being much stronger than the latter.

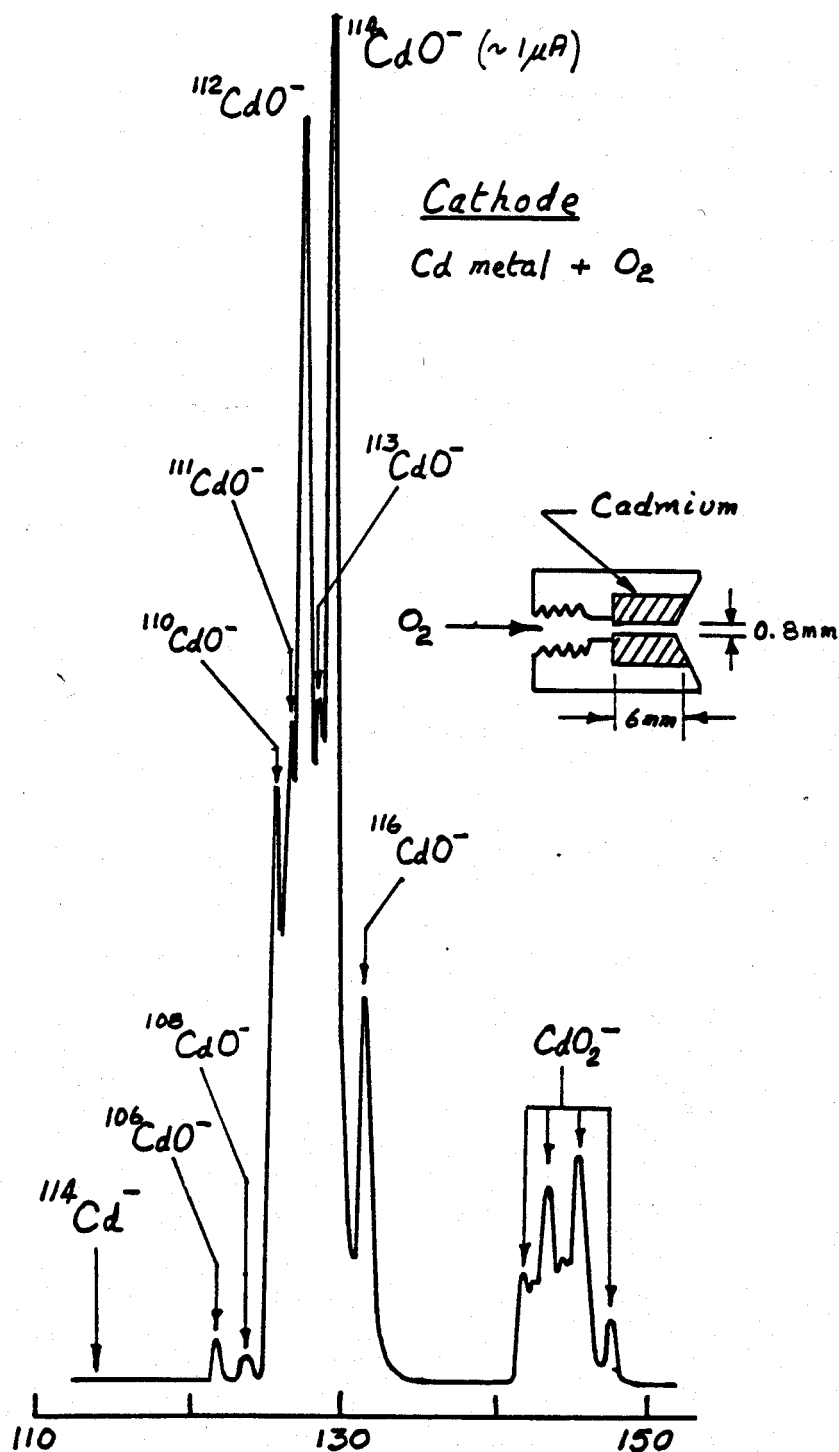

A negative ion spectrum measured with a cadmium metal cathode similar to that shown in the sketch, and with fairly low oxygen flow rate (the oxygen partial pressure in the source was $\sim 4 \times 10^{-7}$ Torr). The $^{114}\text{CdO}^-$ current was maintained around $1\mu\text{A}$ for about 3 hours, but when the cathode was removed it was quite evident that it was running on borrowed time.

A Negative Ion Cookbook

⁴⁹Indium

Isotopes

¹¹³In - 4.3%, ¹¹⁵In - 95.7%

Physical Properties

E.A. = 0.3 eV, I.P. = 5.78 eV, m.p. = 157 °C, W.F. = 4.12 eV

Cathodes

We have made measurements with cathodes containing pressed indium metal, indium oxide (In₂O₃), a mixture of indium and graphite powders and an indium metal gas cathode with oxygen.

Our first pressed metal cathode performed poorly and required more than 2 hours for the ¹¹⁵In⁻ current to climb from 5 nA to 200 nA. Although the currents were less, performance was similar to aluminum and it was clear that the cathode required pre-drilling. A second cathode was prepared by pressing indium into a larger hole than usual (2 mm diameter by 6 mm deep) and then a sharp scribe was pressed into the surface to form a conical depression. This cathode performed better but still took almost an hour for the current to rise to .25 μA. It ran for almost 5 hours and during most of the time the ¹¹⁵In⁻ current was between 0.5 and 0.7 μA. Part of a negative ion spectrum and a sketch of the cathode are shown overleaf. Evident in the spectrum is a peak corresponding to ¹³³Cs⁻ but its intensity (~100 nA) is very much less than that observed from an aluminum cathode.

A gas cathode was made by drilling a 0.6 mm gas admittance hole through a cathode similar to the second one described above. It performed extremely well and even with a very modest flow of oxygen, corresponding to a pressure rise of only 3X10⁻⁷ Torr, produced between 10 and 30 μA of ¹¹⁵InO⁻. Like aluminum oxide, indium oxide is a prolific negative ion and probably is the best choice for acceleration in a tandem. Since solid cathodes are usually more convenient than gas ones, we were anxious to try a cathode containing indium oxide. Unfortunately none was to hand, but after consulting a chemistry book we learned that indium burns in air to form the oxide. It is a little difficult to ignite, burns slowly and releases a white smoke. A cathode prepared from the residue performed well and within a few minutes was producing ~10 μA of ¹¹⁵InO⁻.

We were sufficiently surprised and intrigued to observe in the elemental spectrum, shown overleaf, a peak corresponding to InC₂⁻, to make a cathode from a mixture of indium and graphite powders. The spectrum from this, also shown overleaf, is quite unusual and shows an intense peak (3 to 5 μA) corresponding to ¹¹⁵InC₂⁻ and progressively weaker peaks corresponding to ¹¹⁵InC₄⁻ and ¹¹⁵InC₆⁻ -- the molecules containing odd numbers of carbon atoms appear to be absent.

Molecular Ions

Like aluminum, indium has a strong dimer that usually has 5 times the intensity of the elemental ion. The hydrides of indium might be expected to be plentiful and complex (see Aluminum), but we observed none. In retrospect it is unfortunate that no measurements were made with the gas cathode and hydrogen. The carbides of indium are very unusual and have already been discussed. Indium oxide is a prolific negative ion (by far the most intense molecular ion) and we have also observed a dioxide (InO₂⁻) with about 5% the intensity of InO⁻.

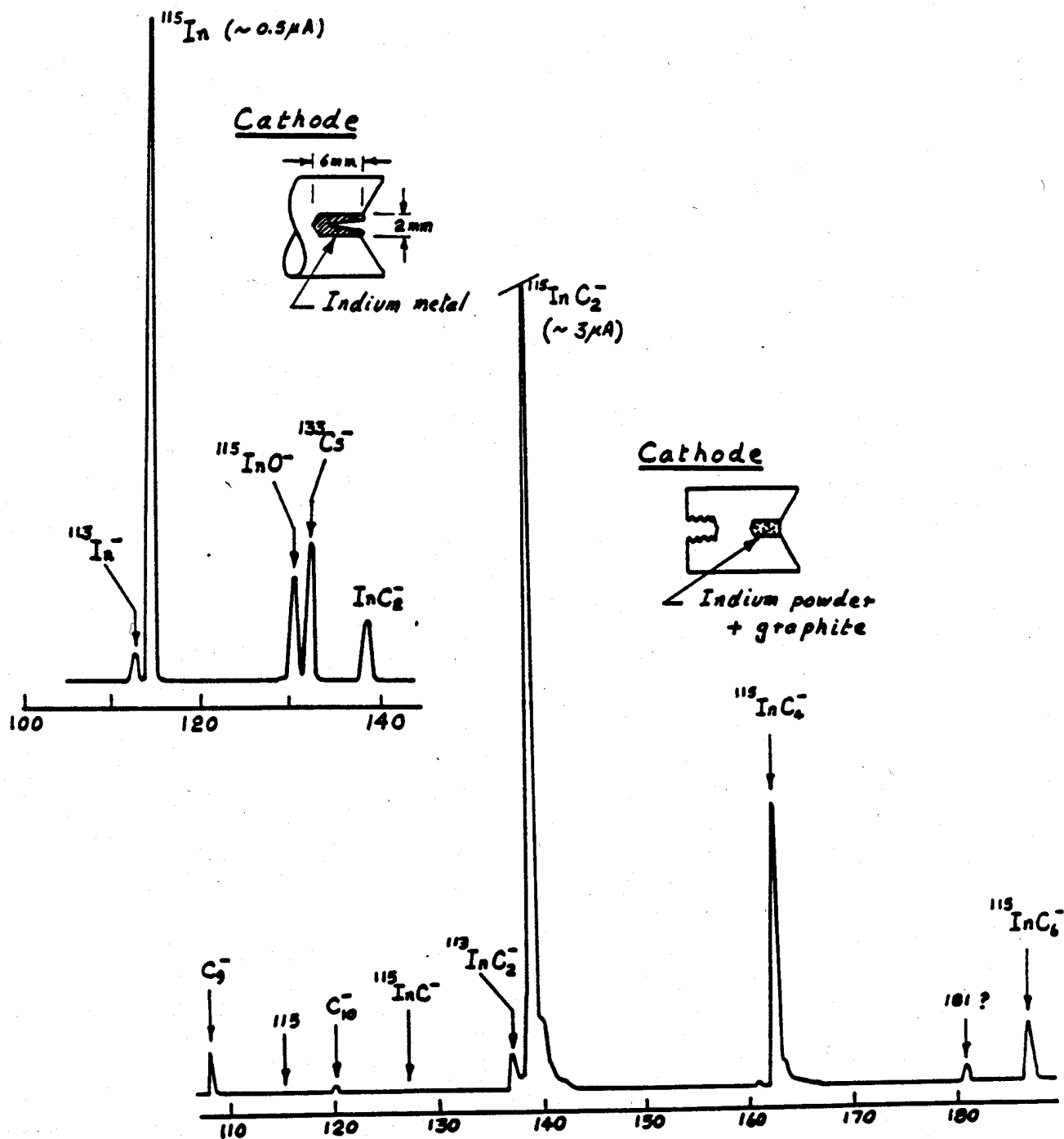

The upper left hand spectrum was recorded with a cathode similar to that shown in the sketch, made from pressed indium metal. Even though it was "pre-drilled" it required 90 minutes for the $^{115}\text{In}^-$ current to climb to $0.5 \mu\text{A}$. In spite of performance closely parallel to that of aluminum, the $^{133}\text{Cs}^-$ peak was much weaker and never exceeded 150 nA. The lower spectrum is the unusual result of measurements made with a cathode containing a mixture of indium and graphite powders. Note the strong molecular ion peaks containing even numbers of carbon atoms and the absence of those containing odd numbers.

A Negative Ion Cookbook

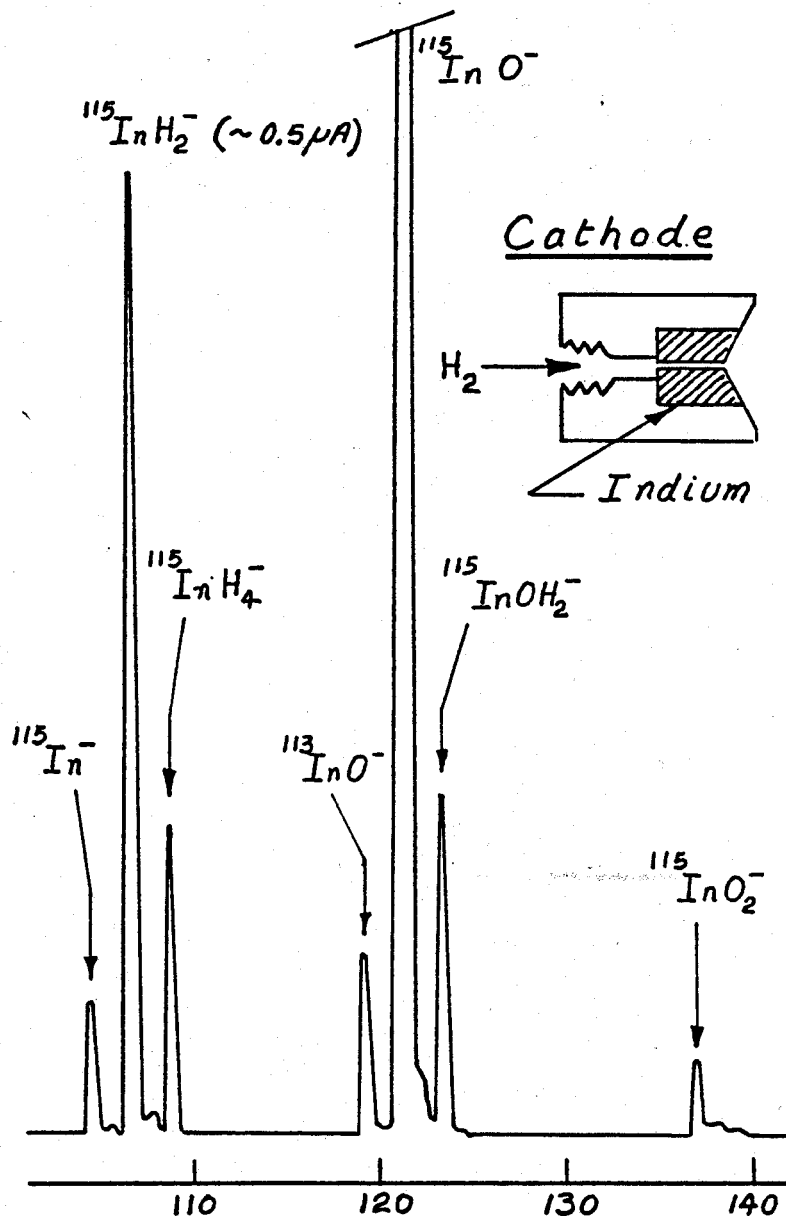

Since the section on indium was written we have had the opportunity to make some measurements with a gas cathode and hydrogen. The spectrum (shown above) resembles that of aluminum, and like aluminum, indium has four hydrides, but the single and tri-hydrides are very weak. Typically we observed 0.5 to 1.0 μA of $^{115}\text{InH}_2^-$, but with moderately high hydrogen flow rates (the partial pressure of hydrogen in the source was about 2×10^{-6} Torr).

A Negative Ion Cookbook

50Tin

Isotopes

¹¹²Sn - 1.0%, ¹¹⁴Sn - 0.7%, ¹¹⁵Sn - 0.4%, ¹¹⁶Sn - 14.7%, ¹¹⁷Sn - 7.7%, ¹¹⁸Sn - 24.3%, ¹¹⁹Sn - 8.6%,
¹²⁰Sn - 32.4%, ¹²²Sn - 4.6%, ¹²⁴Sn - 5.66%

Physical Properties

E.A. = 1.2 eV, I.P. = 7.34 eV, m.p. = 232 °C, W.F. = 4.42 eV

Cathodes

The only cathode we have tried was made from elemental tin. Ours was in the form of very small shot that was poured and then hammered into a hole in a standard copper cathode. The shot appeared to weld together, forming what appeared to be solid tin.

Performance

Unfortunately the tin was not pre-drilled and the negative ion current rose slowly. However, within 30 minutes the ¹²⁰Sn⁻ current was about 1 μA, and a little over an hour later it attained a plateau around 7 μA. Since the current was measured through slits with an opening of ± 1.25 mm, reducing the current by about one half, and the abundance of ¹²⁰Sn is 32.4%, the total tin negative ion current was about 40 μA -- a value commensurate with its electron affinity of 1.2 eV. We were particularly gratified by this result, since on a previous occasion¹ with a UNIS source we were puzzled to obtain only 12 nA of ¹²⁰Sn⁻.

Tin sputters quite rapidly, and cathode life was only a little above 3 hours.

Molecular Ions

Tin forms a most unusual dimer negative ion, whose intensity in relation to the elemental ion varies enormously. The Sn₂⁻ : Sn⁻ ratio was initially 5 : 1, but after an hour or two fell to 1 : 12; i.e. the ratio decreased by a factor of 60. Our spectrum, a portion of which is shown overleaf, was remarkably clean, and the intensities of the elemental peaks match closely their isotopic abundancies, leaving little room for hydrides. For a short time after the cathode was introduced into the source very weak clusters of peaks were observed corresponding to SnO⁻ and SnO₂⁻, but they soon disappeared.

Reference

1) R. Middleton, Nucl. Instr. and Methods **144** (1977) 373.

A Negative Ion Cookbook

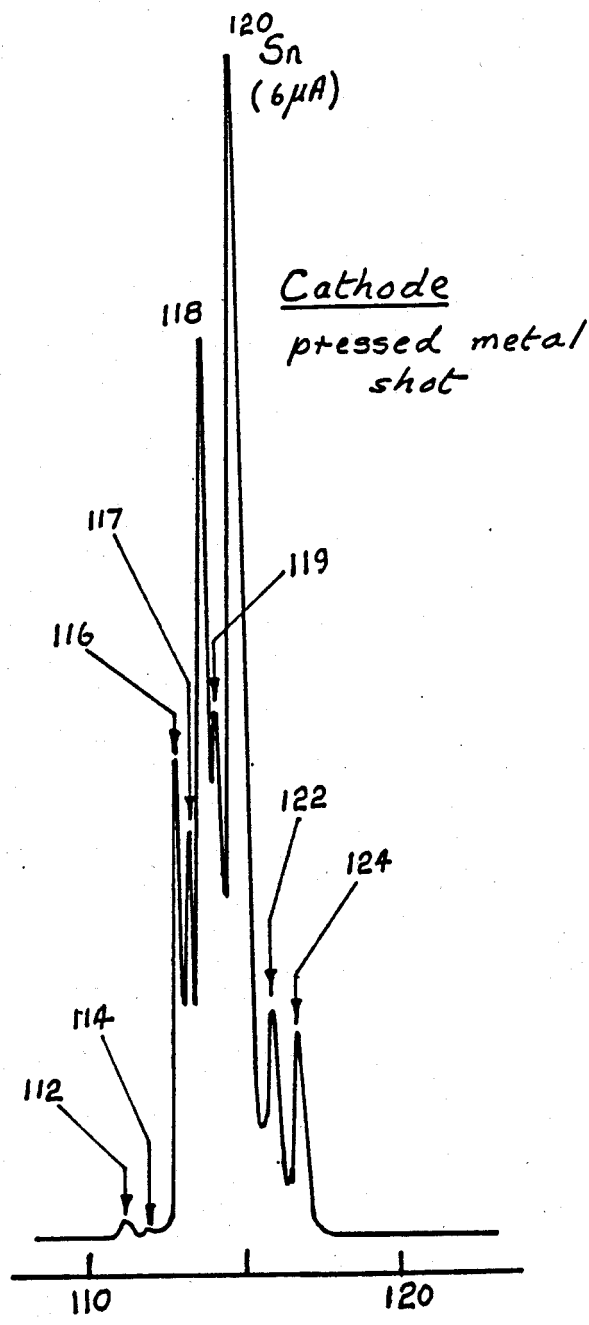

Since tin has an electron affinity of 1.2 eV it is a reasonably prolific negative ion. However its strength is distributed over 10 isotopes, and since fairly narrow slits are required to separate the isotopes, currents are not overly large. In spite of this we were able to maintain about $6\mu\text{A}$ of ^{120}Sn (32.4%) for a little over 2 hours.

A Negative Ion Cookbook

51Antimony

Isotopes

^{121}Sb - 57.3%, ^{123}Sb - 42.7%

Physical Properties

E.A. = 1.07 eV, I.P. = 8.64 eV, m.p. = 631 °C, W.F. = 4.55 eV

Cathodes

Since elemental antimony is very brittle and easy to crush, our first cathodes were made by hammering the element into a 1.6 mm diameter by 3 mm deep hole in a standard copper cathode. These performed unusually badly, and although we glimpsed micro-ampere currents of antimony they were extremely unsteady and erratic. Equally poor performance was once obtained from a cathode containing crushed alumina (not Al_2O_3 powder) and this was attributed to the dielectric nature of the grains. We also unsuccessfully attempted to melt and fuse, using an acid flux, some antimony into a hole in a copper cathode.

Finally we recalled that once while studying lead, two impurity peaks were observed and finally identified as corresponding to $^{121}\text{Sb}^-$ and $^{123}\text{Sb}^-$. (Antimony is commonly alloyed with lead to increase its hardness.) This seemed a promising approach and we attempted to make a 1 : 1 by atom alloy. The appropriate mixture of lead and antimony were melted in an alumina crucible, under argon, in a RF induction furnace forming a small bead. This was then pressed into a slightly undersize hole drilled into a copper cathode. The cathode performed excellently and within a few minutes the currents of $^{121}\text{Sb}^-$ and $^{123}\text{Sb}^-$ exceeded a microamp, and more importantly were completely steady. The currents continued to rise and after about 90 minutes the current of $^{121}\text{Sb}^-$ attained a plateau of about 5 μA . A typical negative ion spectrum measured with this cathode is shown overleaf. Unfortunately, after about 2 ½ hours the current fell dramatically and was accompanied by a fast rising copper current, indicating that the bead was sputtered through -- it was only about 2.5 mm thick.

If a prolonged study were performed, a good procedure would be to cast a 5 or 6 mm diameter rod of alloy so that 6 mm long pieces could be sawn off and pressed into cathodes. Since we didn't wish to go to this length a second slightly larger bead of alloy was made and placed on top of a cathode containing a 3 mm diameter by 5 mm. deep hole. This was then heated under argon and the melted bead flowed into the hole and clearly wetted the copper. It performed about as well as the first alloy cathode and lasted for over 5 hours. However, the presence of a large copper current from the beginning showed that lead-antimony alloy had also alloyed with the copper. Possibly a better procedure is to produce filings of the alloy and to tamp these into a cathode.

Molecular Ions

The only molecular ions that we observed are the oxides SbO^- and SbO_2^- , and from the cathode which alloyed with the copper a weak cluster of peaks corresponding to SbCu^- .

A Negative Ion Cookbook

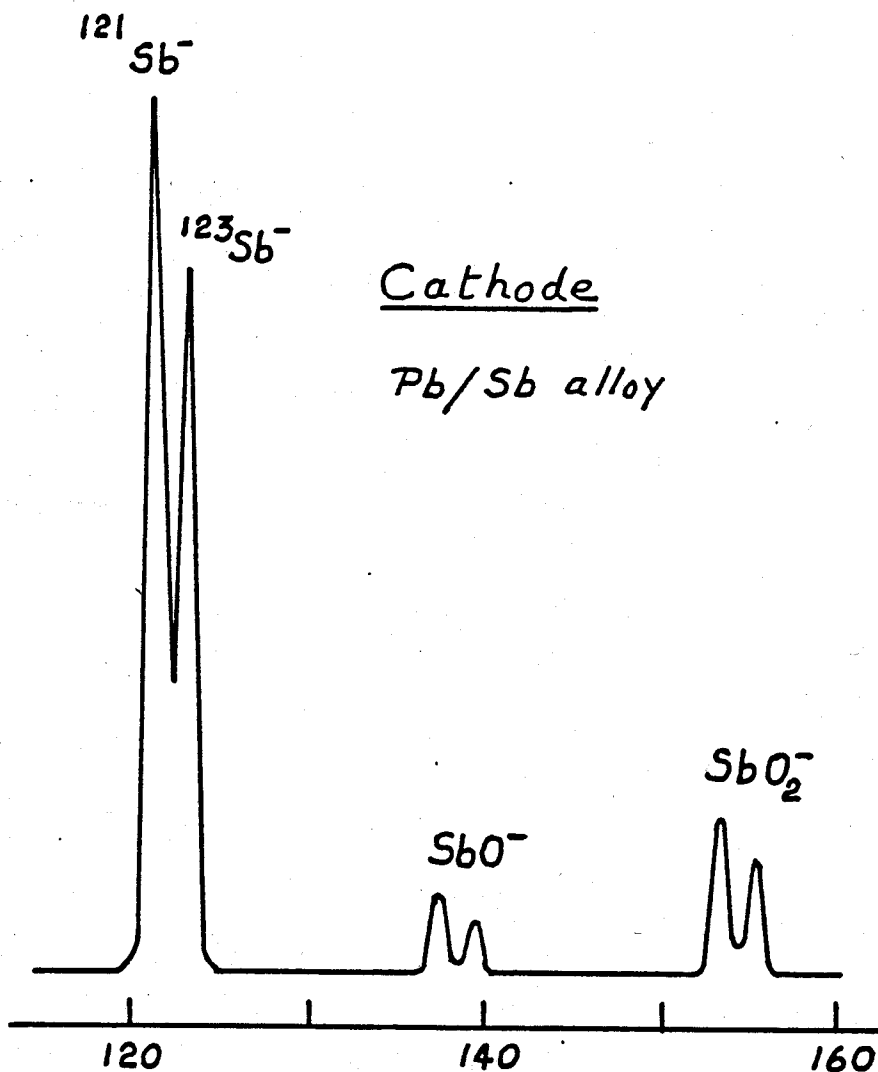

Elemental antimony performs very poorly in a cathode and the above spectrum was obtained with a lead-antimony alloy containing equal atoms of each element. Alloy cathodes perform extremely well and one such cathode produced 4 to 5 μA of $^{121}\text{Sb}^-$ for over 5 hours. The lead current was disappointingly small -- about 50 nA of all isotopes.

A Negative Ion Cookbook

52Tellurium

Isotopes

^{120}Te - 0.096%, ^{122}Te - 2.60%, ^{123}Te - 0.903%, ^{124}Te - 4.816%, ^{125}Te - 7.14%, ^{126}Te - 18.95%, ^{128}Te - 31.69%, ^{130}Te - 33.80%

Physical Properties

E.A. = 1.971 eV, I.P. = 9.01 eV, m.p. = 452 °C, W.F. = 4.95 eV

Cathodes

Since cadmium selenide proved so successful with selenium our first reaction was to try cadmium telluride (CdTe , m.p. = 1041 °C). Like the selenide, the telluride packed well into a standard cathode and looked quite metallic after hammering. It also ran well and within 15 minutes we had analyzed 8 or 9 μA of $^{130}\text{Te}^-$ measured through slits with an opening of ± 1.25 mm. The cathode, which was operated quite conservatively, continued to produce 8 to 10 μA for over 4 hours, and judging from its appearance would probably have run for at least 2 more hours. A portion of a negative spectrum obtained with this cathode is shown overleaf.

Molecular Ions

The spectrum from cadmium telluride was exceptionally clean and the only peaks corresponded to Cu^- (the copper cathode container), Te^- , CuTe^- , CdTe^- , and Te_2^- . With the exception of Te^- all were very weak and the intensity of the dimer was 1 to 2% of the elemental ion.

A Negative Ion Cookbook

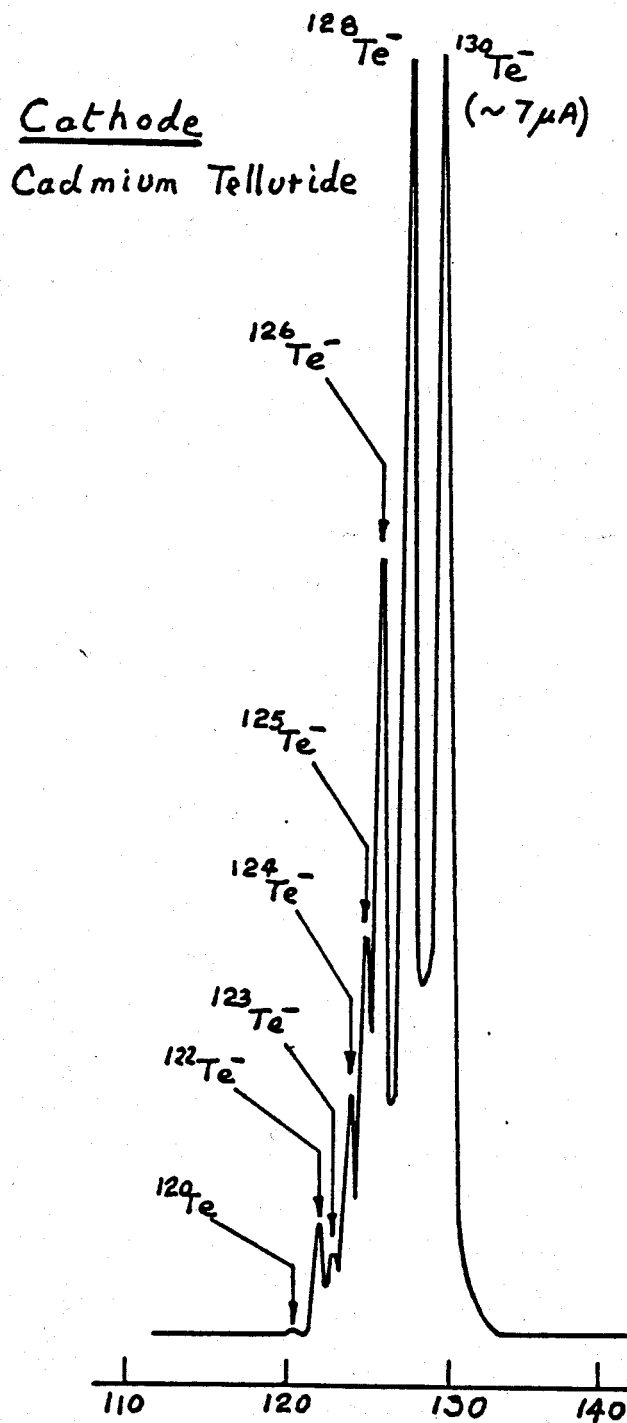

Tellurium, like the other members of group six of the periodic table, is a very prolific negative ion, and the spectrum above was obtained while the source was running conservatively. Cadmium telluride is an excellent cathode material and lifetime at these currents is likely to be 5 or 6 hours.

A Negative Ion Cookbook

⁵³Iodine

Isotopes

¹²⁷I - 100%

Physical Properties

E.A. = 3.059 eV, I.P. = 10.45 eV, m.p. = 113.5 °C

Cathodes

The low melting point and high vapor pressure of elemental iodine preclude its use in a cathode and we have tried two compounds, potassium iodide (KI, m.p. = 681 °C) and cesium iodide (CsI, m.p. = 626 °C). Neither was completely satisfactory, and both performed best when mixed with silver powder.

Performance

Iodine, with an electron affinity of 3.06 eV, is a prolific negative ion and almost any iodide will produce micro-ampere currents. However, most compounds behave poorly in a cathode and tend to run erratically -- a situation that is helped but not completely cured by adding silver powder. Our best results were obtained with cesium iodide, freshly filed from a piece of crystal, which was mixed with silver powder and quickly tamped into a cathode (speed is essential since cesium iodide is deliquescent, or else the operation should be performed in a dry box). In spite of a reduced cathode voltage (6 kV) the ¹²⁷I current climbed quickly and within minutes was ~ 85 μA. Thereafter the negative ion current and the cathode current continued to grow and we were forced to reduce the reservoir temperature to keep the latter in check. We have noticed similar behavior with other alkali metal compounds (particularly those containing rubidium and cesium) and believe that they are the result of self-feeding -- i.e. sputtered rubidium or cesium striking the ionizer is ionized and adds to the cathode current. With care we were able to maintain the ¹²⁷I current between 50 and 100 μA for about 4 hours.

Recommended Cathode

On the basis of our data we would recommend cesium iodide mixed with silver powder, but from the behavior of silver chloride (see Chlorine) it is possible that silver iodide might be a better choice.

Molecular Ions

Like the other halogens, iodine forms a very weak dimer and the I₂⁻ : I⁻ ratio is typically 2X10⁻³. We have never observed a hydride but one appears to exist along with a metastable dihydride¹.

Reference

- 1) L.R. Kilius, J.C. Rucklidge, and A.E. Litherland, Nucl. Instr. and Methods **B29** (1987) 72.

A Negative Ion Cookbook

⁵⁴Xenon

Isotopes

¹²⁴Xe - 0.10%, ¹²⁶Xe - 0.09%, ¹²⁸Xe - 1.91%, ¹²⁹Xe - 29.4%, ¹³⁰Xe - 4.1%, ¹³¹Xe - 21.2%, ¹³²Xe - 26.9%, ¹³⁴Xe - 10.4%, ¹³⁶Xe 8.9%

Physical Properties

E.A. < 0, I.P. = 12.13 eV, m.p. = -112 °C

Cathodes

It is unlikely that xenon forms a stable negative ion, but there is some experimental evidence that it might¹. Minehara et al.² showed that some molecular ions are stable and succeeded in extracting 50 to 150 nA of XeF⁻ ions from a radial extraction P.I.G. source operated on freshly prepared XeF₂ gas. To date we have made no searches for xenon molecular negative ions, but we hope shortly to try to make XeF⁻ by sputtering a mixture of xenon gas and sulfur hexafluoride. We plan to use the highly sensitive techniques of accelerator mass spectrometry to identify the molecule.

References

- 1) D. Elmore, H.E. Gove, R. Ferraro, L.R. Kilius, H.W. Lee, K.H. Chang, R.K. Beakens, A.E. Litherland, C.J. Russo, K.H. Purser, M.T. Murell, and R.C. Finkel, Nature **286** (1980) 138.
- 2) E. Minehara, S. Abe, T. Yoshida, Y. Sato, M. Kanda, C. Kobayashi, and S. Hanasima, Nucl. Instr. and Methods **85** (1984) 217.

A Negative Ion Cookbook

⁵⁵Cesium

Isotopes

¹³³Cs - 100%

Physical Properties

E.A. = 0.472 eV, I.P. = 3.89 eV, m.p. = 28.5 °C, W.F. = 2.14 eV

Cathodes

While studying the polyatomic negative ions of aluminum we noticed a weak peak 2 mass units below Al₅⁻ that undoubtedly corresponded to ¹³³Cs⁻. Its presence was no surprise since most metal cathodes produce a similar peak with an intensity between 20 and 50 nA. However, the intensity grew and at the end of an hour it dwarfed the Al₅⁻ peak and its current was almost 2 μA. After about 2½ hours the ¹³³Cs⁻ current leveled off at an amazing 2.8 μA.

A characteristic of aluminum cathodes, particularly if not pre-drilled, is that the ²⁷Al⁻ current rises slowly and often takes about 2 hours to reach a maximum. If the cathode is viewed through a telescope during this period, a small ball of pale blue plasma usually signals the growth of the Al⁻ current; generally after 30 or 40 minutes. As the plasma intensifies the currents of ²⁷Al⁻ and ¹³³Cs⁻ grow and there can be little doubt that they are related. Also, if the cathode is occasionally removed it becomes apparent that the plasma growth has been accompanied by the excavation of a deep sputter crater in the aluminum. On the following page is a graph showing the growth of the ²⁷Al⁻, ¹³³Cs⁻, and Al₅⁻ currents measured as a function of time.

As already mentioned most metallic cathodes produce a weak Cs⁻ current. We have made measurements with a large range of metals including titanium, iron, nickel, cobalt, copper, niobium, indium, tin, zirconium, molybdenum, tantalum, and tungsten; and only iron produces comparable ¹³³Cs⁻ currents. Overleaf are shown spectra measured with aluminum and iron contrasted with the more typical spectra from copper and nickel.

It seems very likely that the strong Cs⁻ currents are associated with the intense and highly concentrated Cs⁺ beams from a spherical ionizer -- we have never observed the like from a source with a helical ionizer. However, in addition there must be a chemical dependence, otherwise why only from aluminum and iron? We expected to observe a strong Cs⁻ beam from indium, which is in the same chemical group as aluminum, but we didn't. For now, we have no explanations and report only our findings, but we speculate that strong negative ion beams of rubidium might be obtained by substituting rubidium for cesium.

Molecular Ions

Our measurements on cesium have been indirect and incidental and we have made no systematic study of its atomic or molecular negative ions. However, we have frequently observed negative molecular ions and most outstanding are a series formed with carbon; CsC₂⁻, CsC₄⁻, CsC₆⁻, etc. (see Carbon).

A Negative Ion Cookbook

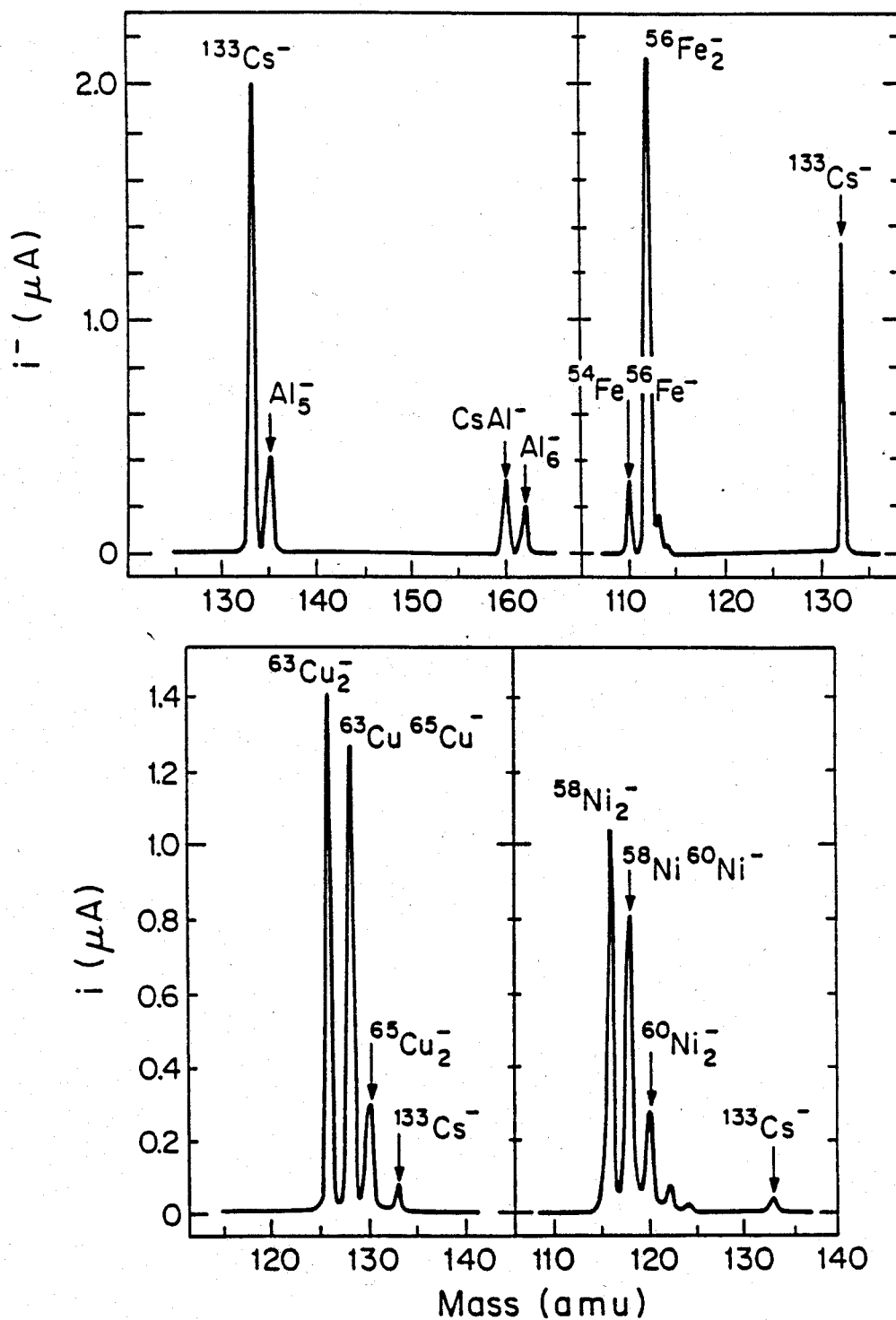

The upper two figures show the strong $^{133}\text{Cs}^-$ currents observed from metallic cathodes of aluminum and iron. The Cs^- currents ($\sim 2 \mu\text{A}$) are fascinating and a puzzle. Most metallic cathodes produce Cs^- currents between 20 and 50 nA such as the copper and nickel cathodes shown in the lower two figures.

A Negative Ion Cookbook

Aluminum also appears to form a somewhat weaker series; CsAl^- , CsAl_2^- , CsAl_3^- , etc. (see spectrum on facing page).

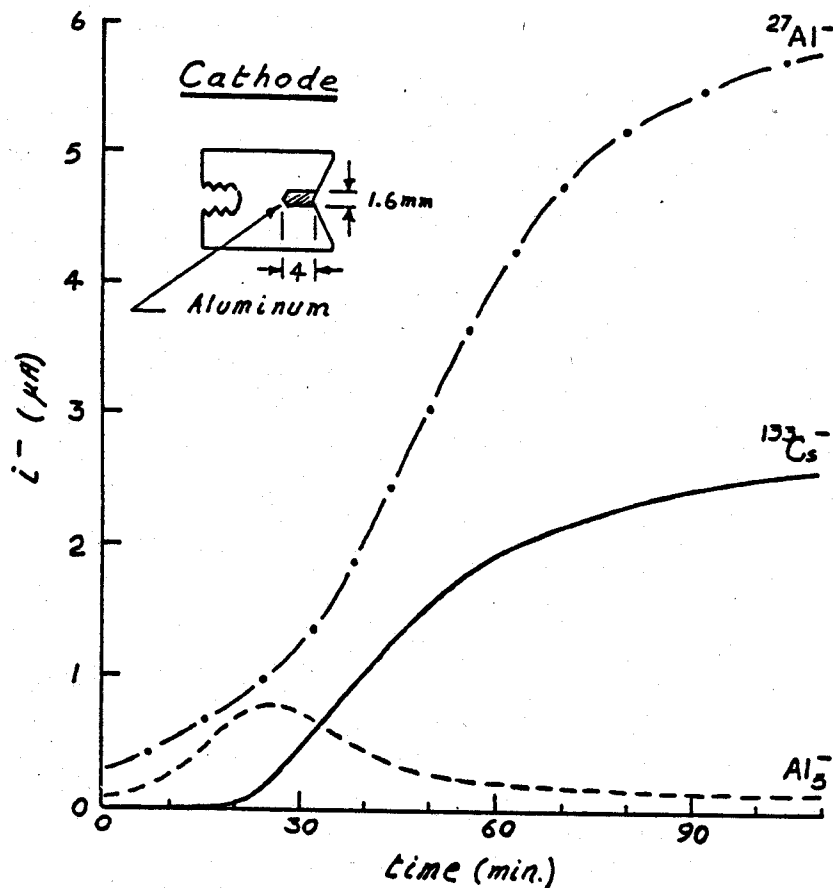

Showing the rise of the $^{27}\text{Al}^-$ and $^{133}\text{Cs}^-$ currents from an aluminum metal cathode similar to that shown in the sketch. Note that the Al_3^- current, which at first exceeds the $^{133}\text{Cs}^-$ current, is eventually dwarfed by the negative cesium current after 1½ hours.

A Negative Ion Cookbook

⁵⁶Barium

Isotopes

¹³⁰Ba - .106%, ¹³²Ba - 101%, ¹³⁴Ba - 2.41%, ¹³⁵Ba - 6.592%, ¹³⁶Ba - 7.854%, ¹³⁷Ba - 11.23%, ¹³⁸Ba - 71.70%

Physical Properties

E.A. < 0, I.P. = 5.21 eV, m.p. = 725 °C, W.F. = 2.7 eV

Cathodes

Barium, like strontium, probably has a negative electron affinity and because of this no measurements were made with elemental cathodes. Instead we followed the procedure used with calcium and strontium and prepared a hydride. A small piece of barium metal was sawn from a bar of barium metal and transferred into the Vycor tube used to make hydrides (see Calcium). At a relatively low temperature, the piece of barium metal glowed bright red and absorbed an appreciable amount of hydrogen. The resulting hydride, presumably BaH₂, was dark gray in color and very brittle. Since it is very hygroscopic it was loaded without delay into a cathode and immediately introduced into the source.

Performance

The barium hydride performed very much like calcium and strontium hydrides, but the currents were generally lower. As with the latter elements the triple hydride was strongest and we estimated that the BaH₃⁻: BaH⁻ ratio was about 7:1 -- the di-hydride was very weak. The ¹³⁹BaH₃⁻ current, measured through slits with an opening of ±1.25 mm, was typically 0.3 to 0.5 μA after the first 30 minutes of growth. A portion of a negative ion spectrum measured with a cathode containing barium hydride is shown overleaf.

Molecular Ions

Because of the many isotopes we cannot be completely sure that barium does not form a weak, but stable, negative ion. To shed more light on this question and on the relative intensities of the hydrides we prepared a cathode from barium deuteride. This confirmed our earlier conclusion that there are 3 hydrides and that the triple hydride is by far the strongest; it did not help with the question of a stable elemental ion.

The spectrum shown overleaf contains peaks corresponding to BaO⁻, and from a comparison with calcium we have little doubt that an oxide cathode would yield about 0.5 μA of ¹³⁹BaO⁻, but probably not much more.

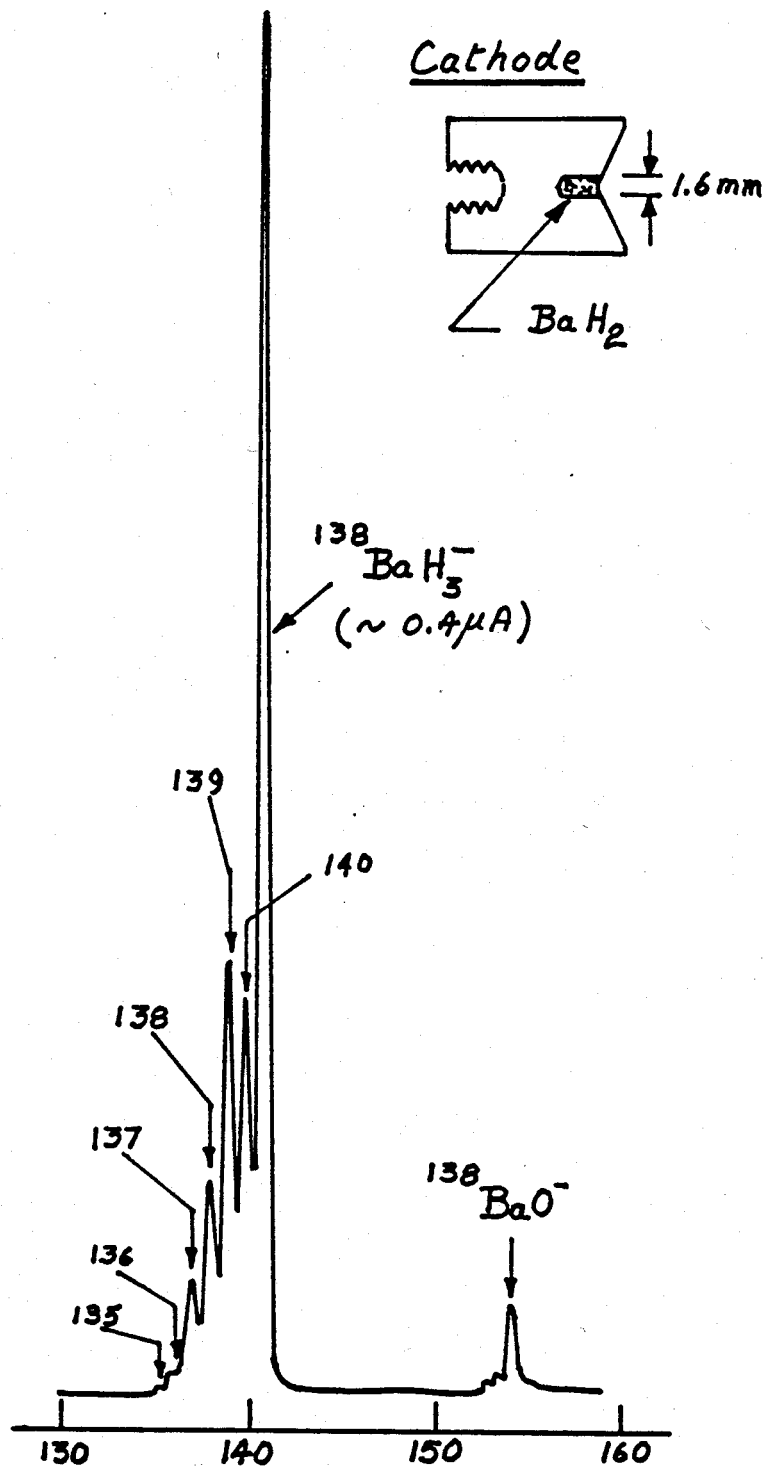

Portion of a negative ion spectrum obtained from a cathode containing home prepared barium hydride (BaH_2). As with calcium and strontium there appear to be three hydrides, but the triple hydride dominates.

A Negative Ion Cookbook

57Lanthanum

Isotopes

^{138}La - 0.09%, ^{139}La - 99.91%

Physical Properties

E.A. = 0.5 eV, I.P. = 5.61 eV, m.p. = 918 °C, W.F. = 3.5 eV

Cathodes

Measurements have been made with cathodes containing lanthanum metal, lanthanum oxide (La_2O_3 , m.p. = 2307 °C) with and without silver powder, sintered lanthanum hexaboride (LaB_6) and a lanthanum metal gas cathode with hydrogen.

Performance

None of the above cathodes performed spectacularly well and we believe that all, to some degree, poisoned the ionizer and impaired its ability to ionize cesium. Lanthanum, like all of the rare earths, has a high melting point, a low vapor pressure and a small work function. We believe that sputtered neutral atoms stick on the ionizer and reduce its work function below the ionization potential of cesium. Although lanthanum's melting point is less than the normal working temperature of the ionizer (~ 1100 °C) its vapor pressure is very small and at 1242 °C it is only 10^{-3} Torr; thus greatly reducing the probability of re-evaporation.

Tabulated below are some results, obtained with a cathode containing lanthanum oxide and silver powder, which clearly illustrate the trend observed with most lanthanum cathodes:-

time (min.)	LaO-(μA)	LaO27(μA)	107 Ag-(μA)	i_c (mA)
15	.31	.77	20	2.1
30	.20	.70	11	1.5
45	.15	.65	4.3	1.2
60	.08	.35	2.0	1.0

Note the steady decline in cathode current and the dramatic fall in the Ag^- current -- both symptomatic of a declining Cs^+ current. At the present time we are at a loss how to cope with this problem. To a certain extent the decline in Cs^+ can be minimized by increasing the ionizer temperature to dangerous levels (> 1250 °C). Other than that, it is necessary to frequently remove the ionizer and to clean its surface by micro-blasting. Overleaf is shown a spectrum obtained with this cathode while the ionizer was being operated at close to 1250 °C.

The elemental cathode was a disappointment but at least it established the existence of the elemental ion and a profusion of molecular ions. The elemental current was small and rarely exceeded 30 nA, suggesting that the electron affinity of lanthanum might be less than its reported value of 0.5 eV. The lanthanum hexaboride cathode also performed disappointingly but it eventually produced about 100 nA of $^{139}\text{LaB}^-$ and a weaker current of $^{139}\text{LaB}_2^-$.

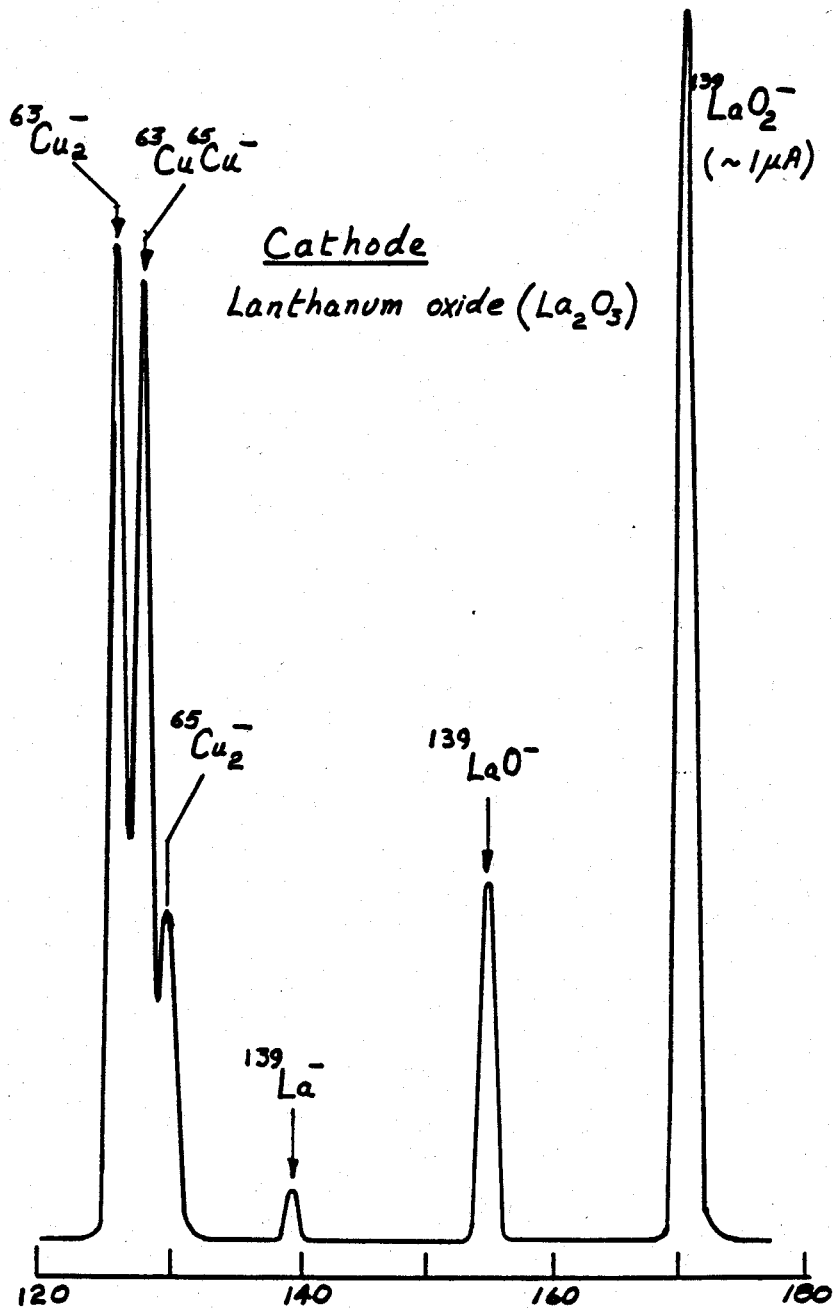

A negative ion spectrum from a cathode containing lanthanum oxide (La_2O_3) mixed with silver powder. Like most lanthanum-containing cathodes it appeared to contaminate and impair the efficient operation of the ionizer. A $^{139}\text{LaO}_2^-$ current could be maintained around $1\ \mu\text{A}$ only by operating the ionizer at a dangerously high temperature of $\sim 1250\ \text{°C}$.

A Negative Ion Cookbook

Our best results were obtained with a lanthanum metal cathode and hydrogen. This ran remarkably well and for reasons not understood the symptoms of ionizer poisoning were much less evident, but the ionizer was operated at a higher temperature than usual. Shown below are spectra measured before and during hydrogen admission. It is evident that lanthanum forms four hydrides with $^{139}\text{LaH}_2^-$ and $^{139}\text{LaH}_4^-$ being particularly strong ($\sim 1.5 \mu\text{A}$). This particular cathode was operated for 90 minutes with an almost constant cathode current of 1.8 mA and with a $^{139}\text{LaH}_4^-$ current ranging from 1.5 to 2.2 μA .

Molecular Ions

Lanthanum very definitely forms a weak elemental ion but we are unsure whether it forms a dimer. Like most rare earths it has 4 hydrides with LaH_2^- and LaH_4^- very strong and LaH^- and LaH_3^- very weak. We have also observed LaB^- and LaB_2^- from a LaB_6 cathode and LaC^- and LaC_2^- from an elemental cathode. The oxides are relatively strong and we typically observed 1 μA of LaO_2^- from an oxide cathode and about 0.25 μA of LaO^- .

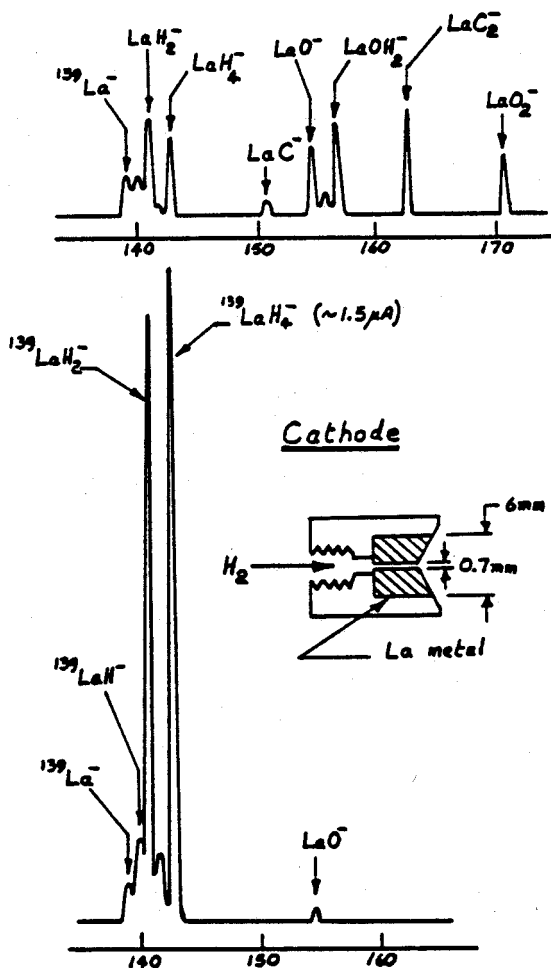

Showing spectra obtained with a lanthanum gas cathode (see inset sketch) before and during hydrogen admission. The cathode performed very well with hydrogen and not only produced 1.5 to 2 μA of $^{139}\text{LaH}_2^-$ and $^{139}\text{LaH}_4^-$ but ionizer poisoning was less of a problem.

A Negative Ion Cookbook

⁵⁸Cerium

Isotopes

¹³⁶Ce - 0.19%, ¹³⁸Ce - 0.2597%, ¹⁴⁰Ce - 88.48%, ¹⁴²Ce - 11.08%

Physical Properties

E.A. = 0.5 eV, I.P. = 5.47 eV, m.p. = 798 °C, W.F. = 2.9 eV

Cathodes

As with lanthanum, we made many measurements and tried several different cathodes including elemental metal, cerium oxide (CeO₂, m.p. ~2600 °C) with and without silver powder, and a metal gas cathode with hydrogen.

Performance

The performance closely paralleled that of lanthanum, and the negative ion and cathode currents from all cathodes tended to decrease with time, indicating ionizer poisoning and deterioration.

The elemental cathode produced a profusion of molecular beams, including several hydrides, an oxide, and a weak current of ¹⁴⁰Ce⁻. As with lanthanum, the elemental current was very small and usually less than 30 nA, suggesting that the electron affinity of cerium is much less than its theoretical estimate of 0.5 eV.

A cathode containing cerium oxide and silver powder behaved a little better and overleaf is shown a spectrum which was recorded after about 15 minutes of operation. Clearly discernable are weak peaks corresponding to ¹⁴⁰Ce⁻, a few hydrides and a moderately intense (~ 0.7 μA) peak of ¹⁴⁰CeO⁻. As usually happens with cathodes containing the rare earths, the cathode and negative ion currents fell with time and only after increasing the ionizer temperature to about 1200 °C were we able to stabilize the ¹⁴⁰CeO⁻ current around 250 nA.

Following our success with lanthanum and hydrogen we prepared a similar gas cathode from cerium metal. Machining the latter, as with lanthanum, was a pyrotechnical delight and we recommend the liberal application of mineral oil. The cathode performed extremely well and with hydrogen produced a spectrum closely resembling that from lanthanum -- fairly intense (~ 1.3 μA) peaks of ¹⁴⁰CeH₂⁻ and ¹⁴⁰CeH₄⁻ and very weak peaks of ¹⁴⁰CeH⁻ and ¹⁴⁰CeH₃⁻. Once again, as with lanthanum, ionizer poisoning was much less troublesome but it was necessary to operate the ionizer at unusually elevated temperatures. This particular cathode performed for over 2 hours producing ¹⁴⁰CeH₂⁻ and ¹⁴⁰CeH₄⁻ currents in the range 1 to 1.4 μA measured through slits which attenuated the true currents at least by a factor of two.

Since the rare earths, like titanium and zirconium, absorb hydrogen exothermically, we attempted to absorb hydrogen in small pieces of lanthanum and cerium metal. Using the apparatus to make calcium hydride (see Calcium), we had no difficulty in initiating the reaction which almost proceeded explosively. However, the hydride seemed to react and fuse with the Vycor tube and when we tried to scrape it from the walls, once again we had a fine display of pyrotechnics. We gave up but the technique proved highly successful with some of the heavier rare earths that are less reactive than lanthanum and cerium.

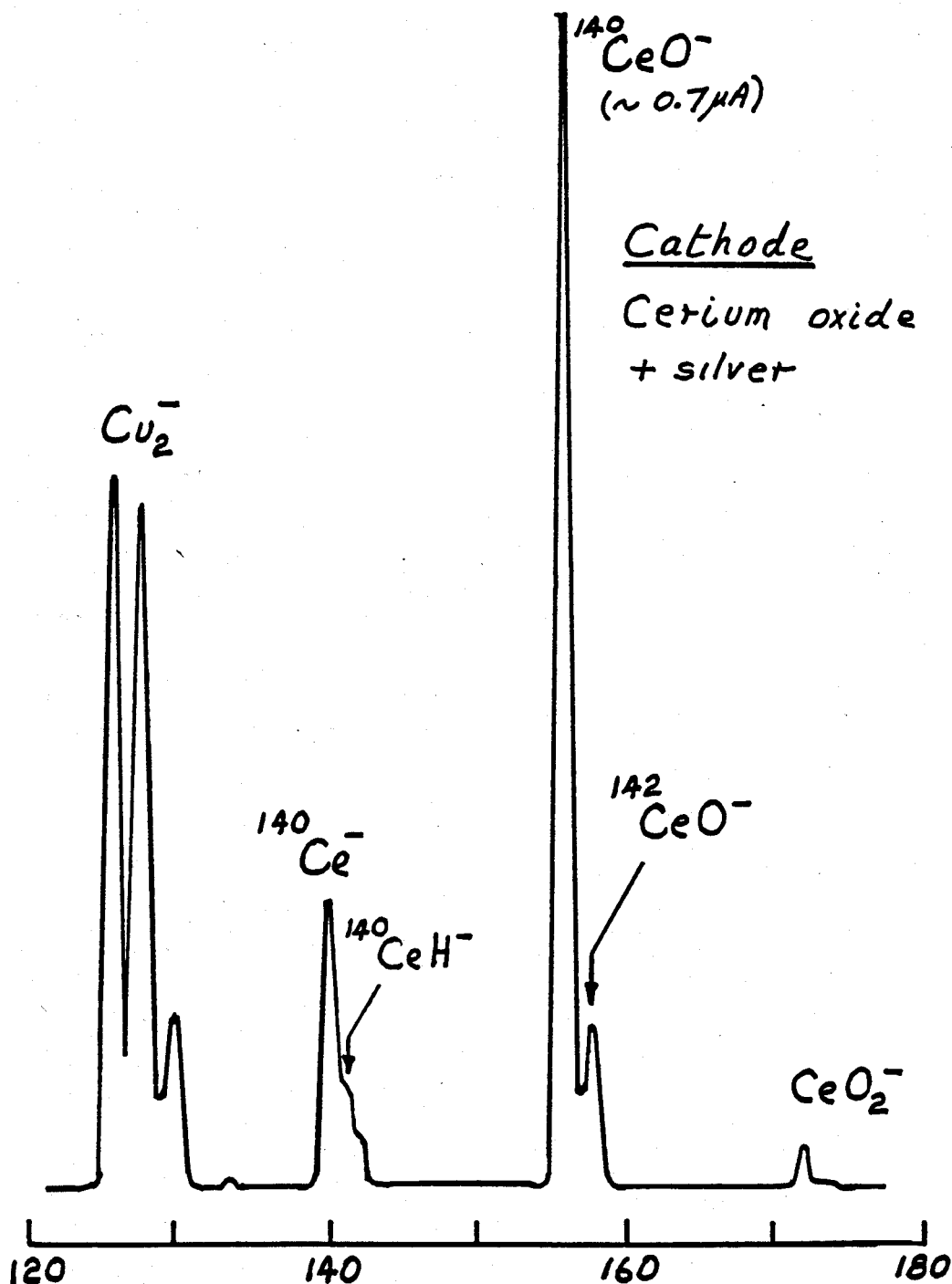

A spectrum obtained with a cathode containing a mixture of cerium oxide (CeO_2) and silver powder. This was measured about 15 minutes after the cathode had been placed in the source and before the ionizer had become contaminated with cerium. Shortly afterwards the $^{140}CeO^-$ current fell below 100 nA and only after the ionizer temperature had been increased to a worrisome 1200 °C did we succeed in stabilizing the current around 250 nA.

A Negative Ion Cookbook

Molecular Ions

Cerium forms a weak elemental ion and may or may not form a dimer. Like lanthanum it forms 4 hydrides, two of which, $^{140}\text{CeH}_2^-$ and $^{140}\text{CeH}_4^-$, are quite intense. A negative ion spectrum, showing the negative hydrides of cerium, is reproduced below. The only other molecular ions that we observed were the oxides -- $^{140}\text{CeO}^-$, from an oxide cathode, was reasonably intense 0.2 to 0.5 μA), and a weak dioxide $^{140}\text{CeO}_2^-$.

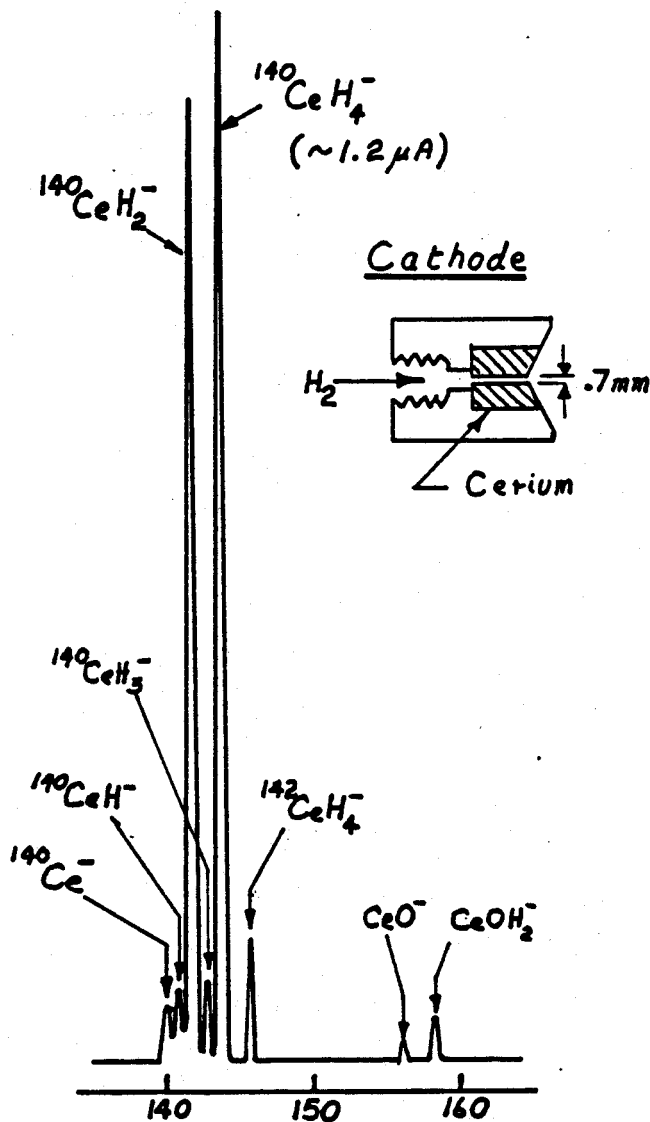

A negative ion spectrum recorded with a cerium metal gas cathode (similar to that shown in the sketch) with hydrogen. The gas flow corresponded to a fairly high hydrogen partial pressure of 2×10^{-8} Torr. Like lanthanum (and most of the rare earths), cerium forms 4 hydrides, the strongest of which are $^{140}\text{CeH}_2^-$ and $^{140}\text{CeH}_4^-$ ($\sim 1.3 \mu\text{A}$).

A Negative Ion Cookbook

59Praseodymium

Isotopes

¹⁴¹Pr - 100%

Physical Properties

E.A. 2= 0, I.P. = 5.42 eV, m.p. = 931 °C, W.F. = ?

Cathodes

Measurements have been made with an elemental cathode prepared from high purity metal, a gas cathode with hydrogen and a cathode containing praseodymium hydride.

The metal is fairly soft, much less reactive than lanthanum and cerium and can be turned without difficulty -- its reactivity appeared comparable to that of calcium. The hydride was prepared following the procedure described earlier for calcium hydride (see Calcium). The metal exothermically absorbed hydrogen at a relatively low temperature and caused an appreciable pressure drop. We are unsure of the composition of the hydride but it is probably of the form PrH_n where n is between 2 and 3. Compared with the hydrides of lanthanum and cerium it is reasonably stable, and on a fairly dry day we had no problem loading it into a standard cathode.

Performance

The elemental cathode produced extremely small currents, most of which corresponded to molecular ions and which slowly decreased in intensity. We are reasonably sure that a weak elemental ion was observed indicating that praseodymium has a positive, but small, electron affinity.

The gas cathode, with hydrogen, produced a negative ion spectrum that in general shape was almost indistinguishable from those of lanthanum and cerium -- four hydrides with XH₂⁻ and XH₄⁻ particularly strong. However, the overall intensities were very much less -- close to two orders of magnitude! The operation of the source had previously been checked with a copper cathode and appeared excellent, and the cathode currents with praseodymium were normal and in the range 3 to 3.5 mA. In short it was not the source but rather it is likely that the electron affinities of praseodymium hydrides are much less than those of lanthanum and cerium hydrides.

The cathode containing praseodymium hydride performed marginally better and a typical negative ion spectrum obtained with this is shown overleaf. In spite of healthy cathode currents, the currents of PrH₂⁻ and PrH₄⁻ remained low and rarely exceeded 50 nA.

Molecular Ions

The elemental cathode revealed a very weak elemental ion and we didn't look for a dimer. Like most of the rare earths, praseodymium forms four hydrides with PrH₂⁻ and PrH₄⁻ strongest -- however, all of the hydrides are weak and about 2 orders of magnitude less than those from lanthanum and cerium. The elemental cathode confirmed the existence of two carbides, PrC⁻ and PrC₂⁻, and two oxides, PrO⁻ and PrO₂⁻. Admittance of hydrogen produced a peak of PrOH₂⁻ rivaling that of PrO⁻ -- the existence of an XOH₂⁻ ion appears common with the rare earths.

A Negative Ion Cookbook

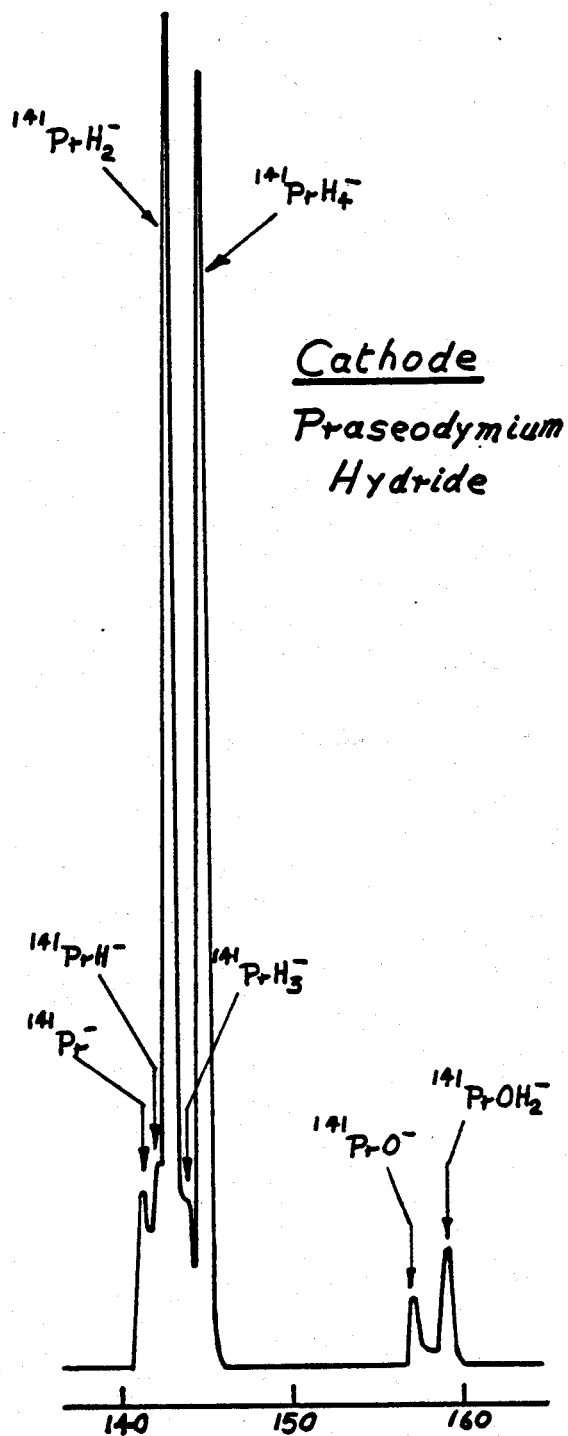

Portion of a negative ion spectrum obtained with a standard cathode loaded with "home" prepared praseodymium hydride. This performed only marginally better than an elemental gas cathode and hydrogen, and the currents of $^{141}\text{PrH}_2^-$ and $^{141}\text{PrH}_4^-$ were disappointingly small - at best ~ 50 nA.

A Negative Ion Cookbook

⁶⁰Neodymium

Isotopes

¹⁴²Nd - 27.13%, ¹⁴³Nd - 12.18%, ¹⁴⁴Nd - 23.80%, ¹⁴⁵Nd - 8.30%, ¹⁴⁶Nd - 17.19%, ¹⁴⁸Nd - 5.76%,
¹⁵⁰Nd - 5.64%

Physical Properties

E.A. -@@ -0.3 eV, I.P. = 5.49 eV, m.p. = 1021 °C, W.F. = 3.2 eV

Cathodes

Measurements have been made with a metal gas cathode with hydrogen and oxygen and with a cathode containing neodymium oxide (Nd₂O₃, m.p. ~ 1900 °C). The high purity metal was purchased in 1 cm size irregular chunks. Fortunately it is much more stable in air than lanthanum and cerium and we had little difficulty in sawing and filing a piece that could be mounted in a lathe and turned to about 5 mm diameter rod. The metal is quite soft and turns like lead. The gas cathode was prepared by pressing a small piece of the rod into a cathode as shown in the inset sketch overleaf.

Performance

The gas cathode, before gas, performed poorly and generally was typical of the rare earths. The negative ion spectrum was complex, and the currents were not only small but also fell with time, along with the cathode current. In the spectrum (shown overleaf at the top of the page) peaks could be identified corresponding to several hydrides and oxides, and probably to NdC₂⁻, but not to the elemental ion.

As expected hydrogen greatly increased the intensity of the hydrides (see lower spectrum), but their intensities (~ 20 nA) were more in keeping with those of praseodymium and not the micro-ampere currents observed with lanthanum and cerium. As with praseodymium, after the ionizer temperature was increased the source appeared to perform reasonably well, suggesting that the hydrides of these two elements must have unusually low electron affinities. Since neodymium has several isotopes it was difficult to determine the relative strengths of the hydrides, but we are reasonably sure that NdH₂⁻ and NdH₄⁻ are the strongest. Interestingly, the spectrum has a shoulder corresponding to mass 142, which was completely absent before hydrogen was admitted. This may correspond to the elemental ion ¹⁴²Nd⁻ (27.13% abundance) -- it is not uncommon for an elemental peak to grow when gas is admitted.

The same cathode was later used with oxygen. Performance was better than with hydrogen but not spectacularly so, producing currents of ¹⁴²NdO⁻ between 30 and 100 nA. On a totally different occasion we also made measurements with a standard cathode loaded with neodymium oxide (without silver). Performance was even worse than with the gas cathode, probably as a result of ionizer poisoning.

A Negative Ion Cookbook

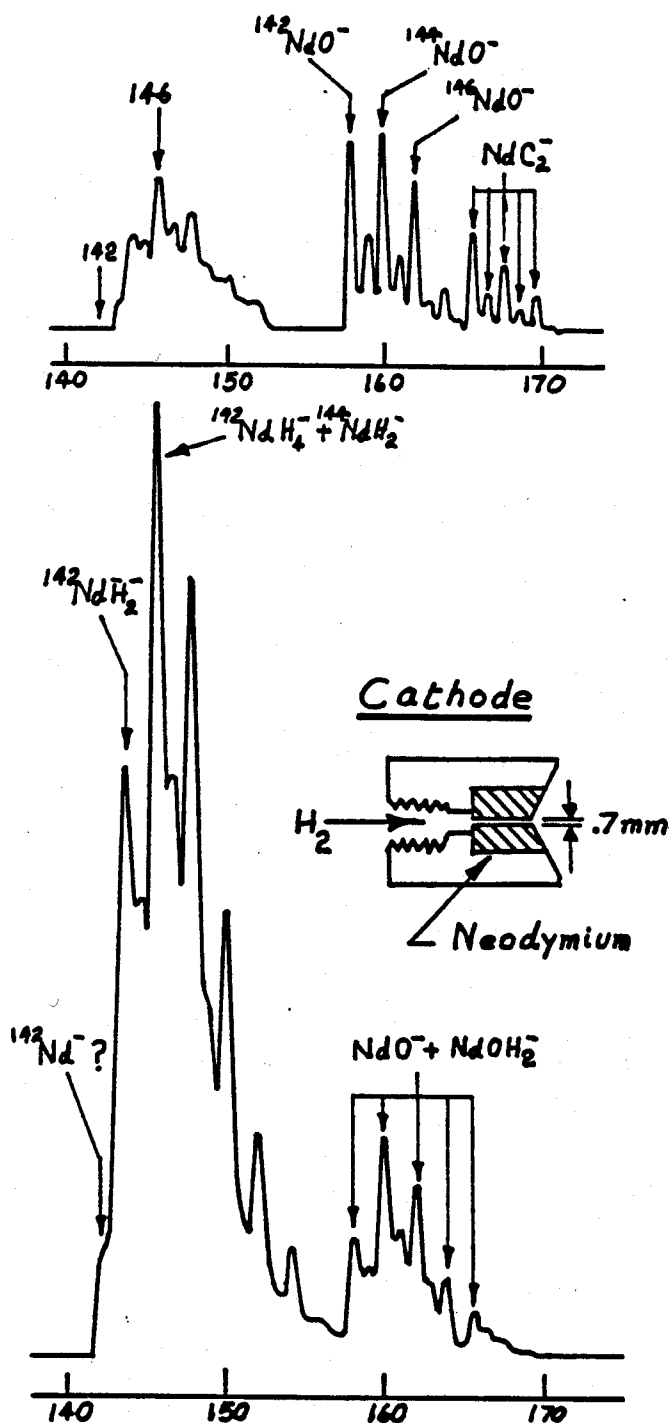

These two spectra were measured with a neodymium metal gas cathode similar to that shown in the sketch, the upper one before gas and the lower one with hydrogen. Although it is difficult to unravel the relative intensities of the hydrides due to the number of neodymium isotopes, we believe that there are the usual 4, with NdH_2^- and NdH_4^- strongest. However, as with praseodymium they are all extremely weak and the strongest was only ~ 20 nA. Note the weak shoulder at mass 142 that appears when hydrogen is admitted -- this may correspond to the elemental ion $^{142}\text{Nd}^-$.

A Negative Ion Cookbook

Molecular Ions

We think it probable that neodymium does form a stable negative ion, but its electron affinity must be extremely small. Like most rare earths neodymium almost certainly forms 4 hydrides, with NdH_2^- and NdH_4^- the strongest, but as with praseodymium all are extremely weak. The strongest molecular ion that we observed was NdO^- , accompanied by a much weaker NdO_2^- .

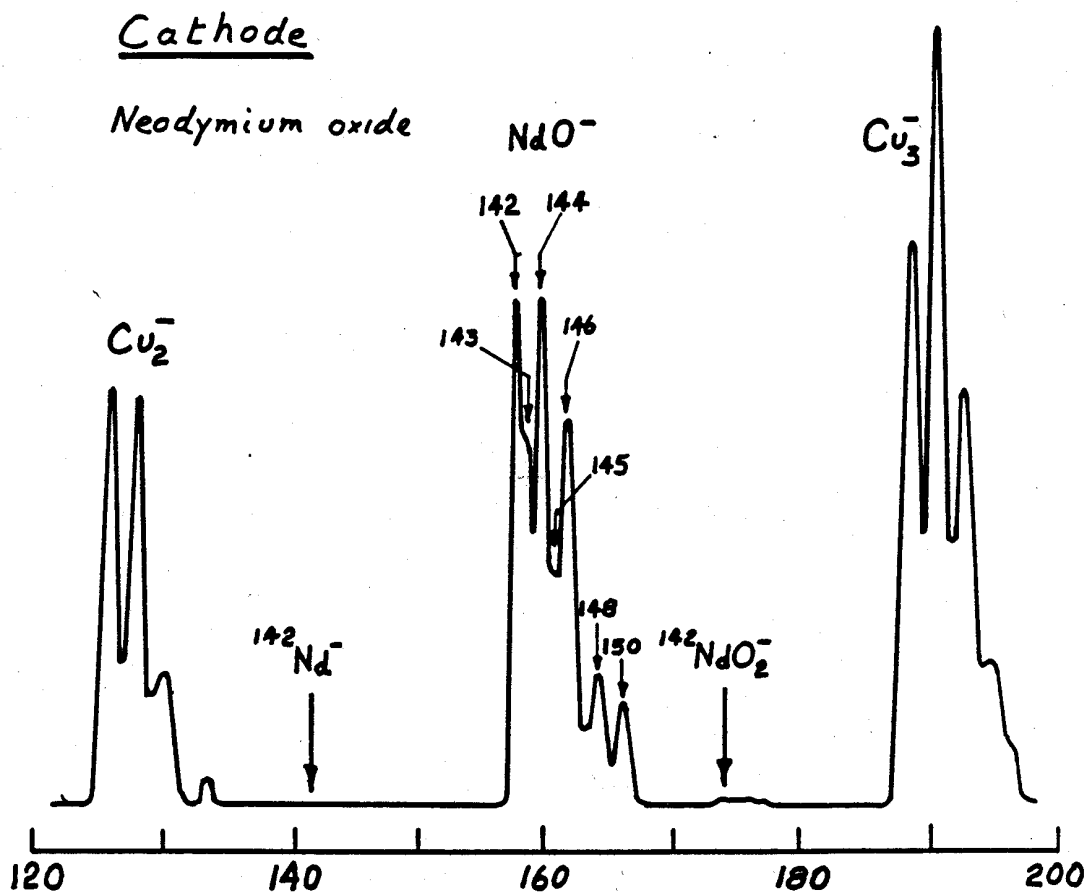

This spectrum was measured with a cathode containing neodymium oxide (Nd_2O_3) without silver. Performance was not good and it was quite evident that neodymium was sticking to the ionizer surface and impairing its ionization efficiency. Even with the ionizer running at close to 1200°C the cathode current was small ($\sim 1\text{ mA}$) and the largest oxide current was about $100\ \mu\text{A}$ of $^{142}\text{NdO}^-$ (measured through a slit opening of $\pm 1.25\text{ mm}$).

A Negative Ion Cookbook

₆₁Promethium

Isotopes

Promethium isotopes, which range in mass from 134 to 155, are all radioactive. The longest-lived isotope is ¹⁴⁵Pm that has a half-life of 17.7 years and decays by internal conversion.

Physical Properties

E.A. ~ -0.3 eV, I.P. = 5.5 eV, m.p. = 1042 °C, W.F. = ?

Cathodes

No measurements have been made with promethium.

A Negative Ion Cookbook

⁶²Samarium

Isotopes

¹⁴⁴Sm - 3.1%, ¹⁴⁷Sm - 15.0%, ¹⁴⁸Sm - 11.3%, ¹⁴⁹Sm - 13.8%, ¹⁵⁰Sm - 7.4%, ¹⁵²Sm - 26.7%, ¹⁵⁴Sm - 22.7%

Physical Properties

E.A. \approx 0.3 eV, I.P. = 5.63 eV, m.p. = 1074 °C, W.F. = 2.7 eV

Cathodes

Measurements have been made with a samarium metal gas cathode with hydrogen and with a standard cathode filled with samarium oxide (Sm₂O₃). The gas cathode (see sketch overleaf) was made from an irregular piece of 99.9% pure metal which was first sawn and then turned into a 5 mm diameter rod. The metal is not very reactive in air and we had no difficulty in making the gas cathode.

Performance

The gas cathode before gas produced a very complex and generally weak (no peaks > 20 nA) spectrum. If any elemental ions were formed they were overwhelmed by more intense hydrides, particularly SmH₂⁻ and SmH₄⁻. The oxide SmO⁻ was also evident and peaks with almost the correct intensities were identified corresponding to all samarium isotopes except ¹⁴⁴Sm. A much weaker cluster of peaks was observed corresponding to SmO₂⁻.

Hydrogen gas caused spectacular growth of the hydride peaks and overleaf is shown a spectrum where the intensity of ¹⁵⁴SmH₄⁻, measured through slits with an opening of \pm 1.25 mm, is 0.2 μ A. Although SmH₂⁻ and SmH₄⁻ are the strongest hydrides it is fairly evident that SmH⁻ is the stronger and we estimate the SmH₄⁻: SmH₂⁻ ratio is 4 or 5 to 1. It is interesting that after allowance is made for the 22.7% abundance of ¹⁵⁴Sm the strengths of the hydrides are comparable with those of lanthanum and cerium, and very much larger than those of praseodymium and neodymium.

The cathode containing samarium oxide (without silver powder) performed disappointingly and the ¹⁶O⁻ current, which was initially about 120 μ A rapidly fell to about 30 μ A, a sure indication of ionizer poisoning. The samarium oxide currents were very weak and the largest that we observed was 20 nA of ¹⁵²SmO⁻. It is highly probable that larger currents (and better performance) might have been obtained with the gas cathode and oxygen.

Molecular Ions

Although we looked very carefully we were unable to positively identify the elemental negative ion. However, the unusual abundancies of the samarium isotopes coupled with the ever-present hydrides made the search more difficult and the existence question remains open. Samarium, like most of the rare earths, has 4 hydrides with SmH₂⁻ and SmH₄⁻ the strongest, the last mentioned being particularly intense. The oxides, particularly SmO₂⁻ were very weak, but it is likely that this was largely a result of ionizer poisoning.

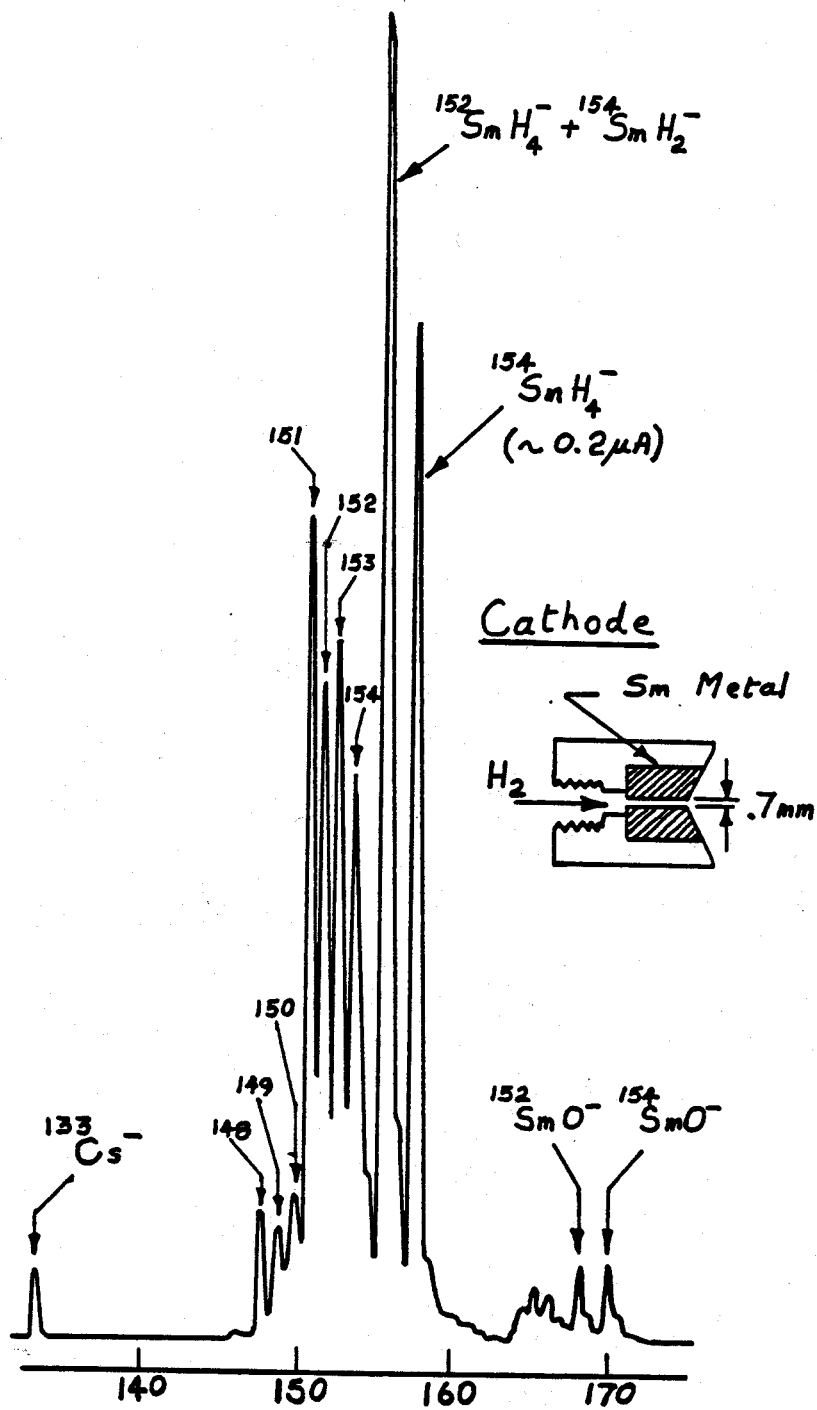

Showing the intense hydrides of samarium obtained with a gas cathode, as shown in the inset, and hydrogen. As with other rare earths samarium forms 4 hydrides, with SmH_4^- the strongest. Although samarium is thought to have a positive electron affinity we observe no evidence of the elemental ion.

A Negative Ion Cookbook

⁶³Europium

Isotopes

¹⁵¹Eu - 47.8%, ¹⁵³Eu - 52.2%

Physical Properties

E.A. \approx -0.3 eV, I.P. = 5.67 eV, m.p. = 822 °C, W.F. = 2.5 eV

Cathodes

The first cathodes that we tried were prepared from europium oxide of dubious purity. Even when mixed with silver powder they performed erratically and produced only about 30 nA of ¹⁵¹EuO⁻ and 50 nA of ¹⁵¹EuO₂⁻, and no peaks were observed corresponding to the elemental ions.

Recently we obtained a small quantity of high purity europium metal. This appeared to be reasonably stable in air and a small piece was placed in a Vycor tube and converted to hydride in the apparatus used to prepare calcium hydride -- see Calcium. At quite a low temperature (~ 300 to 500 °C) the metal exothermically absorbed hydrogen and for a few seconds glowed a bright red. The resulting chunk of hydride looked very much like calcium hydride and appeared to be at least as stable in air. We experienced no difficulty in crushing it and loading it into the cathode.

Performance

The hydride cathode performed very well and within minutes was producing about 1 μ A of ¹⁵¹EuH₄⁻ and ¹⁵³EuH₄⁻. The current slowly climbed to around 2 μ A, and in spite of some signs of ionizer poisoning we were able to maintain it at this level for about 3 hours (the ionizer was operated at a slightly higher temperature than usual). As can be seen from the spectrum shown overleaf, the di- and tetra-hydrides dominate with the latter being the strongest. Also evident is a weak but quite definite peak corresponding to the elemental ion ¹⁵¹Eu⁻, establishing that europium has a small but positive electron affinity. The H⁻ current from this cathode was between 15 and 25 μ A.

Cathode

Europium hydride

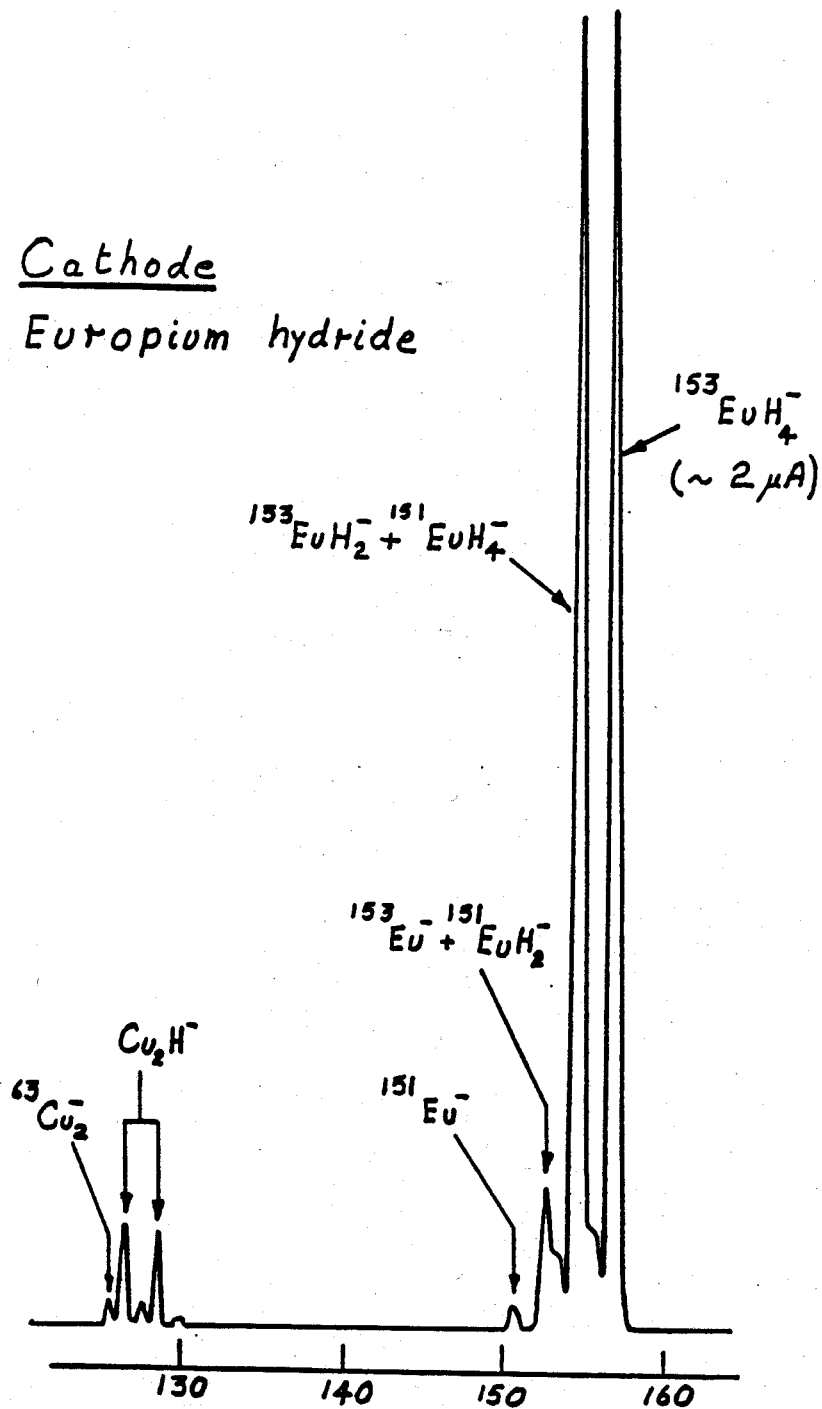

A portion of a negative ion spectrum obtained from a cathode containing some home-prepared europium hydride. Performance was excellent and after a short period of growth the $^{151}\text{EuH}_4^-$ and $^{153}\text{EuH}_4^-$ currents were both about $2 \mu\text{A}$. Note the weak but quite definite peak corresponding to the elemental ion $^{151}\text{Eu}^-$, which establishes that europium has a positive electron affinity.

A Negative Ion Cookbook

⁶⁴Gadolinium

Isotopes

¹⁵²Gd - 0.20%, ¹⁵⁴Gd - 2.18%, ¹⁵⁵Gd - 14.80%, ¹⁵⁶Gd - 20.47%, ¹⁵⁷Gd - 15.65%, ¹⁵⁸Gd - 24.84%,
¹⁶⁰Gd - 21.86%

Physical Properties

E.A. \approx 0.5 eV, I.P. = 6.14 eV, m.p. = 1313 °C, W.F. = 3.1 eV

Cathodes

Measurements have been made with a standard cathode loaded with high purity 40 mesh gadolinium powder, and a gas cathode with hydrogen. The latter was made from a piece of 6 mm, diameter gadolinium rod and resembled those made with other rare earths (see Lanthanum, Cerium, etc.).

Performance

The cathode containing powdered gadolinium performed disappointingly, and as with many rare earths the negative ion and cathode currents were not only small but also tended to decline with time. After the current had been stabilized by raising the temperature of the ionizer, the most prominent feature in the negative ion spectrum was a cluster of peaks corresponding to GdO^- , the strongest member of which, $^{158}\text{GdO}^-$, was only 40 nA. A weaker cluster was also observed corresponding to the hydrides and possible elemental ions of gadolinium.

The gas cathode, with hydrogen, performed much better, and overleaf are shown spectra measured before and during hydrogen admission. Hydrogen dramatically increased the intensity of the hydrides, and the $^{160}\text{GdH}_4^-$ current increased from 8 to 400 nA. Thus it appears that gadolinium, like samarium, joins the ranks of lanthanum and cerium in producing intense hydrides, unlike praseodymium and neodymium. For reasons not understood, hydrogen once again seemed to lessen the poisoning effect of sputtering a rare earth element.

Molecular Ions

In spite of its estimated electron affinity of 0.5 eV we observed no evidence for an elemental ion -- only its hydrides. The latter are quite intense and with an optimized hydrogen flow the $^{160}\text{GdH}_4^-$ current was a respectable 0.4 μA . As usual, GdH_2^- and GdH_4^- were the most intense hydrides, with the latter the strongest -- we estimate the $\text{GdH}_4^- : \text{GdH}_2^-$ ratio to be about 4 : 1, similar to that of samarium. Gadolinium certainly forms the single oxide GdO^- (see spectrum overleaf) and probably a dioxide that we failed to detect.

A Negative Ion Cookbook

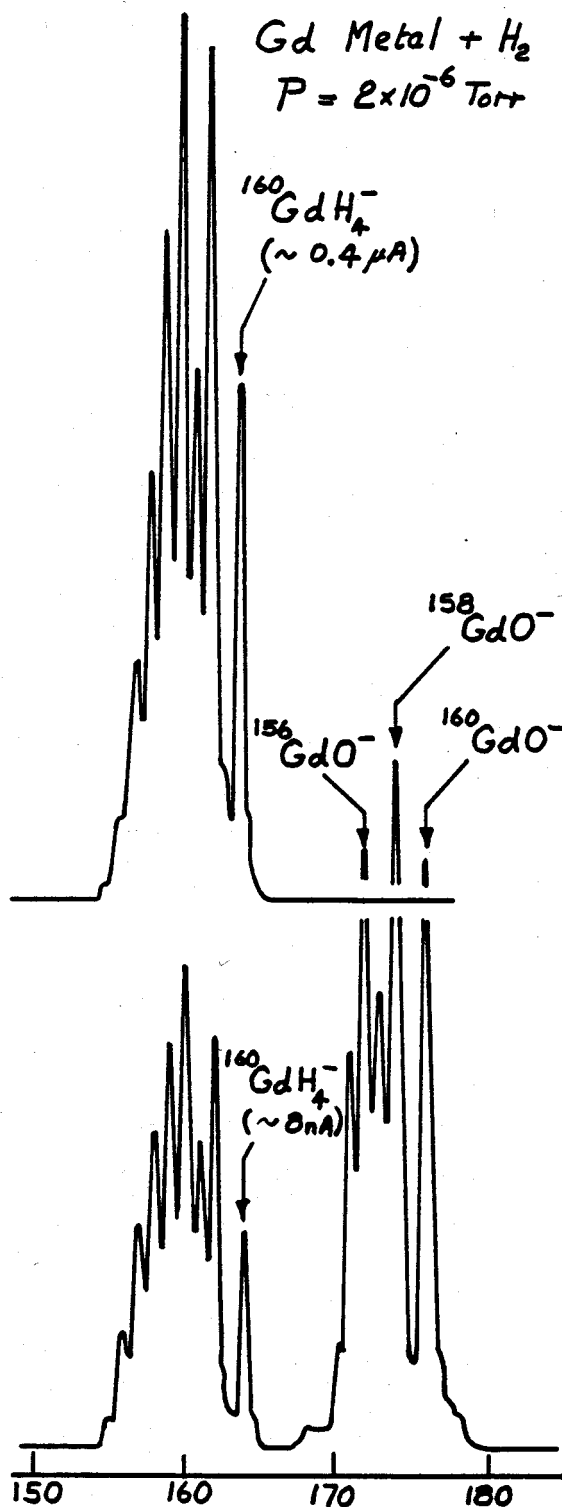

The lower spectrum was measured before gas admission with a gadolinium gas cathode similar to those used with lanthanum and cerium. Above is shown the transfigured spectrum measured after hydrogen was admitted - note the growth of the $^{160}\text{GdH}_4^-$ peak from 8 nA to 400 nA. As usual with the rare earths, GdH_2^- and GdH_4^- are the strongest hydrides, but the latter appears to be about 4 times stronger than the former.

A Negative Ion Cookbook

⁶⁵Terbium

Isotopes

¹⁵⁹Tb - 100%

Physical Properties

E.A. \approx 0.5 eV, I.P. = 5.85 eV, m.p. = 1356 °C, W.F. = 3.50 eV

Cathodes

The only cathodes that we have tried contained terbium metal loaded with hydrogen. This was prepared in the same apparatus used to make calcium and other hydrides (see Calcium). Like other rare earth metals, terbium absorbed hydrogen exothermically, the take-up being signaled by a sweep of red heat passing through the small metallic sample. The hydride was dark gray in color and very brittle, but fortunately it was not overly reactive and handling was no problem.

Performance

Like most of the rare earths, terbium forms four hydrides with ¹⁵⁹TbH₂⁻ and ¹⁵⁹TbH₄⁻ particularly strong. Within the first 5 to 10 minutes the current of ¹⁵⁹TbH₄⁻ rose to about 0.25 μ A only to level and then begin a gradual but steady decline. Since this was accompanied by a falling cathode current it seemed very likely that ionizer poisoning was responsible. To combat this the ionizer temperature was increased from its normal value of \sim 1100 °C to between 1250 and 1300 °C (a dangerously high temperature for a heater insulated with aluminum oxide). The effect was dramatic and the negative ion current immediately began to rise and soon topped 1 μ A. Provided the ionizer temperature was not reduced the negative ion current remained reasonably steady, varying between 0.8 and 1.3 μ A, over a 3 hour period. The behavior of terbium generally reinforces our belief that rare earth metals tend, because of their high melting points and low vapor pressures, to condense on the ionizer and reduce its ability to ionize cesium. The only recourse appears to be operating the ionizer at an elevated temperature.

Overleaf is shown a typical negative ion spectrum measured with this cathode. In addition to the four hydride peaks, very definite peaks are identifiable corresponding to the elemental ion and to the oxide, ¹⁵⁹TbO⁻.

Molecular Ions

Terbium very definitely forms a stable negative ion and has a positive electron affinity. Like most rare earth metals it forms four hydrides with XH₂⁻ and XH₄⁻ the strongest -- it also forms an oxide, ¹⁵⁹TbO⁻.

A Negative Ion Cookbook

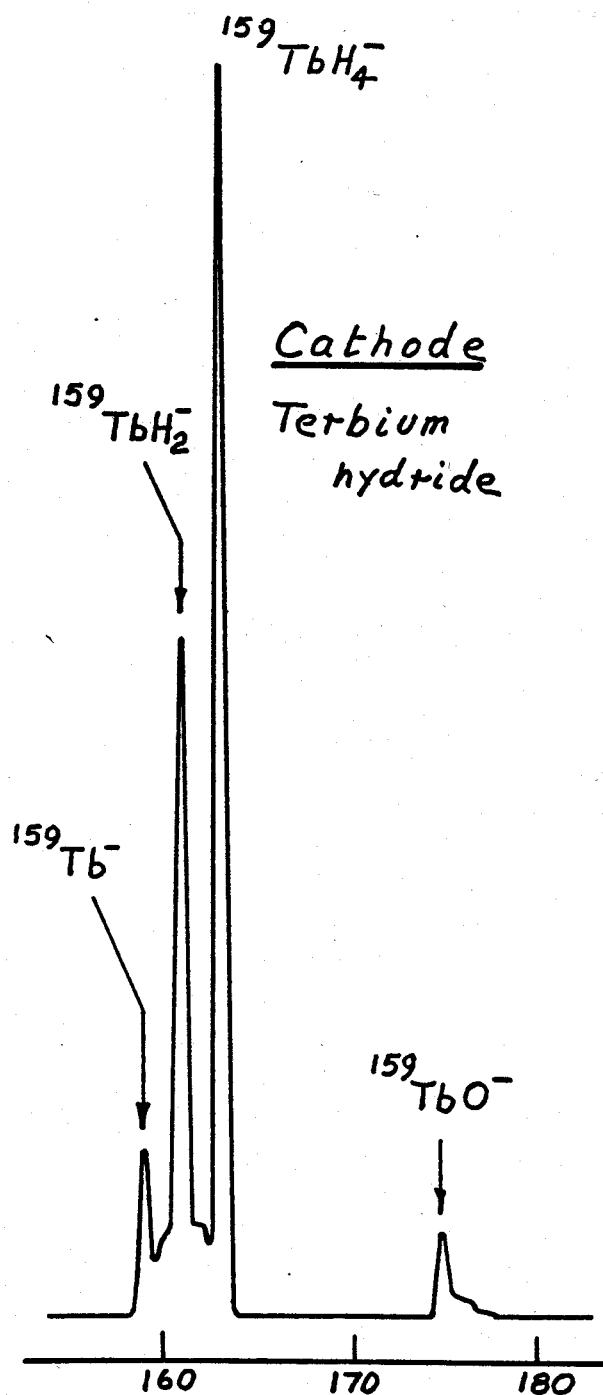

A negative ion spectrum measured with a cathode containing terbium metal loaded with hydrogen. Like most rare earth metals, terbium forms four hydrides with TbH_2^- and TbH_4^- being particularly strong. Terbium also very definitely forms an elemental negative ion and therefore has a positive electron affinity (probably less than the theoretical estimate of 0.5 eV).

A Negative Ion Cookbook

⁶⁶Dysprosium

Isotopes

¹⁵⁶Dy - 0.06%, ¹⁵⁸Dy - 0.10%, ¹⁶⁰Dy - 2.34%, ¹⁶¹Dy - 18.9%, ¹⁶²Dy - 25.5%, ¹⁶³Dy - 24.9%, ¹⁶⁴Dy - 28.2%

Physical Properties

E.A. \approx -0.3 eV, I.P. = 5.93 eV, m.p. = 1412 °C, W.F. = ?

Cathodes

The only cathode that we have tried was made from 40 mesh dysprosium powder. This was hammered into a 3 mm diameter hole drilled into a standard copper cathode and then a 0.7 mm diameter gas admittance hole was drilled completely through the cathode.

Performance

Before gas, the dominant peaks corresponded to DyO⁻ and the intensities of these closely matched their isotopic abundancies. However, intensities were low and the ¹⁶⁴DyO⁻ current was only 110 nA. Admitting hydrogen greatly enhanced the hydride, but currents remained low and the intensity of ¹⁶⁴DyH₄⁻ was only about 80 nA. The complexity of the hydride spectrum, which was almost certainly dominated by DyH₂⁻ and DyH₄⁻ ions, prevented us from observing elemental ions and we are unable to confirm the theoretically predicted negative electron affinity of dysprosium.

Dysprosium was among the first rare earths that we studied and in retrospect a much better procedure would have been to convert the metallic powder into hydride.

Molecular Ions

Typical of the rare earths, dysprosium probably has four hydrides with DyH₂⁻ and DyH₄⁻ the strongest. The only oxide that we observed was DyO⁻.

A Negative Ion Cookbook

⁶⁷Holmium

Isotopes

¹⁶⁵Ho - 100%

Physical Properties

E.A. \approx -0.3 eV, I.P. = 6.02 eV, m.p. = 1470 °C, W.F. = ?

Cathodes

We have made measurements with only 2 cathodes, one containing holmium hydride and the other holmium deuteride. The hydride and deuteride were made using the apparatus and procedure described earlier for making calcium hydride (see Calcium). In both cases the reaction occurred at a relatively low temperature and a small piece of metal absorbed an appreciable amount of gas, causing a noticeable pressure drop. The hydride appeared reasonably stable in air and we experienced no difficulty loading it into a cathode.

Performance

Before any measurements were made with the holmium hydride cathode the source was cleaned and its performance verified with a copper cathode. Performance was good and after 30 minutes or so the ⁶³Cu⁻ current was about 65 μ A with a cathode current of only 1.7 mA. The holmium hydride cathode behaved spectacularly well and within minutes was producing 1 to 2 μ A of ¹⁶⁵HoH₄⁻, measured through slits adjusted to \pm 1.25 mm. The general features of the negative ion spectrum (see overleaf) came as no surprise, showing extremely weak peaks of HoH⁻ and HoH₃⁻ and relatively strong peaks of HoH₂⁻ and HoH₄⁻. However, we were somewhat surprised to observe a small but distinct peak corresponding to elemental holmium since the element was thought to have a negative electron affinity. It was to confirm this identification that prompted us to make a deuteride cathode. Substituting deuterium for hydrogen has the effect of spreading the spectrum out and makes the distinction between elemental and hydride ions clearer. The deuteride spectrum (shown overleaf) is very similar to that from the hydride and confirms the identification of the elemental ion.

The deuteride currents were generally less than the hydrides and after 10 or 15 minutes began to fall even lower. Although the source was only operated for a total of about 30 minutes with both cathodes we think that the ionizer was becoming contaminated and losing its ionization efficiency. It is noteworthy that the melting point of holmium is 1470 °C and its boiling point 2700 °C -- indicating that it has a very low vapor pressure.

Molecular Ions

We are fairly confident that holmium forms a weak but stable elemental ion, indicating a small positive electron affinity. Like most rare earths it forms 4 hydrides and as usual the even hydrides are strongest. Weak oxide peaks (¹⁶⁵HoO⁻) appear in both the hydride and deuteride spectra and probably weaker peaks of HoOH⁻ and HoOH₂⁻.

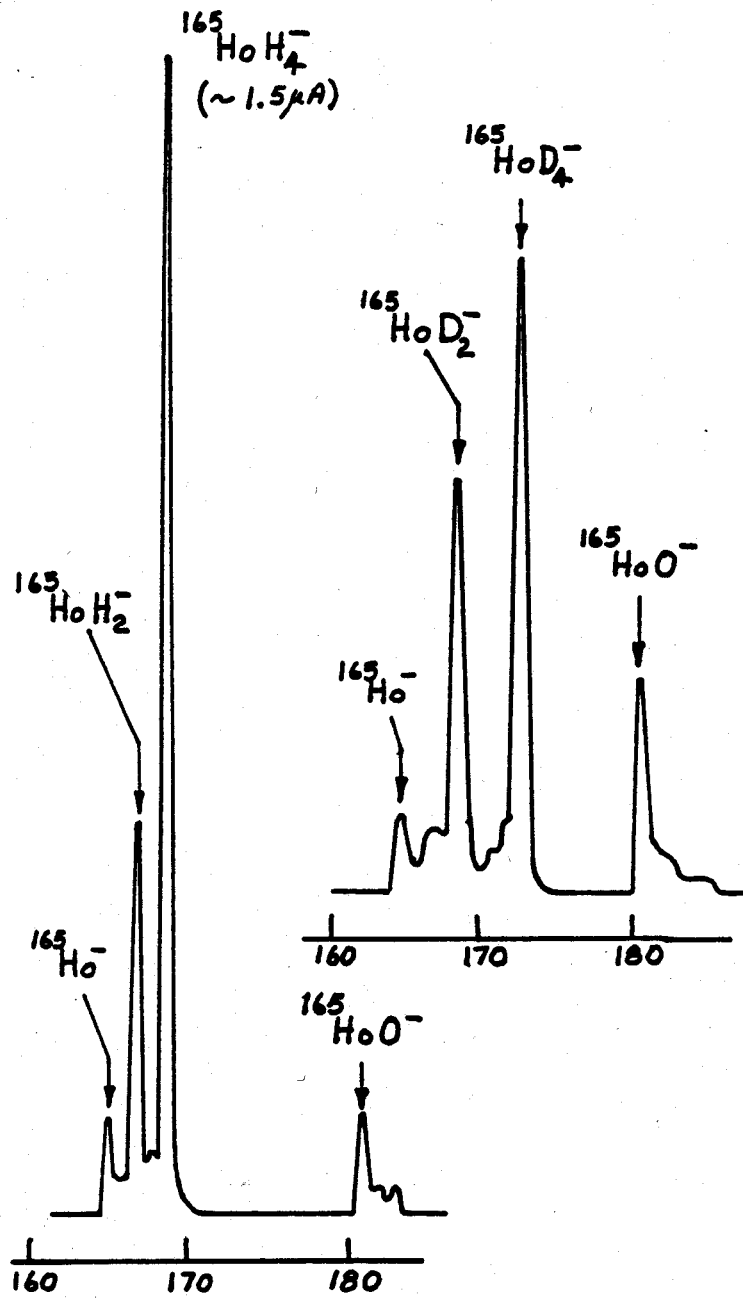

The lower left-hand spectrum was measured with a cathode containing holmium hydride. In addition to the usual 4 hydrides a weak peak is identified corresponding to the elemental ion, indicating that holmium has a positive, but small, electron affinity. Measurements made with a cathode containing holmium deuteride (upper right-hand spectrum) confirm the identification of the elemental ion.

A Negative Ion Cookbook

Erbium

Isotopes

^{162}Er - 0.14%, ^{164}Er - 1.61%, ^{166}Er - 33.6%, ^{167}Er - 22.95%, ^{168}Er - 26.8%, ^{170}Er - 14.9%

Physical Properties

E.A. \approx -0.3 eV, I.P. = 6.10 eV, m.p. = 1529 °C, W.F. = ?

Cathodes

No measurements have been made with erbium, but we would expect the hydride to be the best cathode material, particularly since the element is predicted to have a negative electron affinity. However, the high melting point is ominous and is likely to cause ionizer contamination.

A Negative Ion Cookbook

⁶⁹Thulium

Isotopes

¹⁶⁹Tm - 100%

Physical Properties

E.A. \approx 0.3 eV, I.P. = 6.18 eV, m.p. = 1545 °C, W.F. = ?

Cathodes

The only cathode that we have tried was made from a small piece of high purity thulium metal which was loaded with hydrogen. This was made following the procedure described earlier for making calcium hydride (see calcium), and like other rare earth metals the piece of thulium glowed brightly while absorbing hydrogen. The hydride was black and very brittle and did not appear to be particularly reactive, and we had no difficulty loading it into a cathode.

Performance

Performance was generally similar to other rare earth hydrides, producing fairly strong peaks of ¹⁶⁹TmH₂⁻ and ¹⁶⁹TmH₄⁻. The currents were very definitely related to ionizer temperature and the largest current of ¹⁶⁹TmH₄⁻ that we observed, 0.9 μ A, occurred at an uncomfortably high temperature of 1250 °C. Even then, after about 30 minutes the negative ion and cathode currents both fell precipitously, indicating that the ionizer had become contaminated. Overleaf is shown a typical negative ion spectrum where a weak peak is identified corresponding to ¹⁶⁹Tm⁻, confirming that thulium has a positive electron affinity.

Molecular Ions

Like most of the rare earths, thulium forms four hydrides, with ¹⁶⁹TmH₂⁻ and ¹⁶⁹TmH₄ strongest. A weak oxide ion was also observed.

A Negative Ion Cookbook

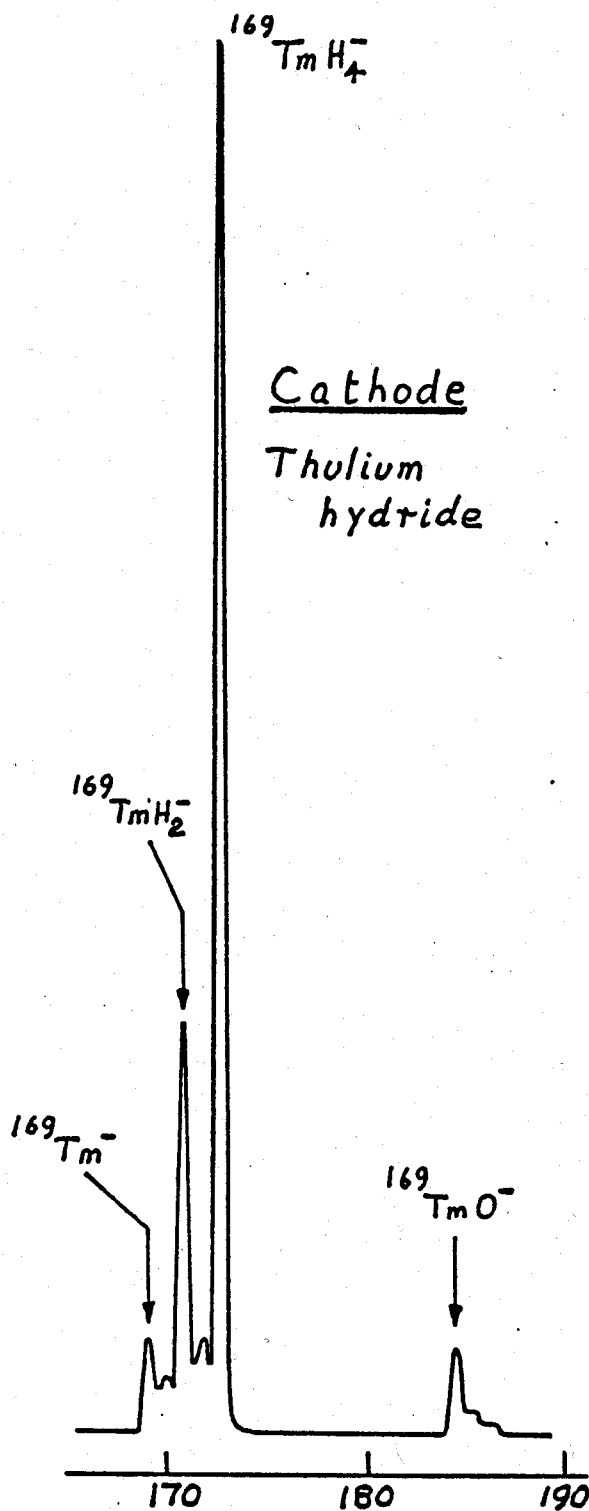

A negative ion spectrum measured with a cathode containing thulium metal loaded with hydrogen. The current of $^{169}\text{TmH}_4^-$ varied between 0.3 and 0.9 μA , depending on the temperature of the ionizer. In spite of operating the latter at a dangerously high temperature ($\sim 1250^\circ\text{C}$), the ionizer appeared to become contaminated after about 30 minutes and the negative ion and cathode currents fell precipitously.

A Negative Ion Cookbook

⁷⁰Ytterbium

Isotopes

¹⁶⁸Yb - 0.13%, ¹⁷⁰Yb - 3.05%, ¹⁷¹Yb - 14.3%, ¹⁷²Yb - 21.9%, ¹⁷³Yb - 16.12%, ¹⁷⁴Yb - 31.8%, ¹⁷⁶Yb - 12.7%

Physical Properties

E.A. \approx 0.5 eV, I.P. = 6.25 eV, m.p. = 819 °C, W.F. = ?

Cathodes

The only cathode that we have tried was a gas cathode prepared from an old piece of ytterbium metal, of unknown origin but with a claimed purity of 99.9%. The metal, which is very soft, was hammered into a 3 mm diameter by 5 mm. deep hole in a copper cathode and then a 0.7 mm gas admittance hole was drilled through the assembly. Measurements were made with both hydrogen and oxygen.

Performance

Before hydrogen was admitted the spectrum contained three clusters of peaks, corresponding to a hydride and two oxides (YbO^- and YbO_2^-). The oxides were surprisingly strong and the current of $^{174}\text{YbO}^-$ was almost 100 nA, indicating that the ytterbium metal was more oxidized than it appeared. Admitting hydrogen had remarkably little effect and produced little more than a factor of two increase in the hydride currents. Equally unusual was that the hydride cluster appeared to contain no peaks corresponding to YbH_4^- -- the hydride ion which normally dominates most rare earth spectra. Examination of the spectrum, which is shown overleaf, reveals that the only hydride of significance is YbH_2^- . Indeed the shape of the hydride cluster is almost identical to that of the single oxide, which is undoubtedly almost entirely YbO^- . Thus, the hydrides of ytterbium present two surprises, 1) they are unusually weak (the largest current was 80 nA of $^{174}\text{YbH}_2^-$) and 2) there appears to be no YbH_4^- .

The same cathode was used and responded well to oxygen, and the intensity of the YbO^- cluster grew by almost an order of magnitude. A spectrum that was recorded while oxygen was being used is shown on the following page. Note, that the current of $^{174}\text{YbO}^-$, which was measured through slits with an opening of ± 1.25 mm, was about 1 μA .

The ytterbium cathode performed quite well both with hydrogen and oxygen, and showed less evidence of ionizer poisoning and contamination than usual. It is possible that this is due to ytterbium having lower melting and boiling points (819 °C and 1196 °C respectively) than most other rare earths -- hence it is more likely to be re-evaporated from the ionizer. We intend to pursue this aspect more fully.

Molecular Ions

Although the electron affinity of ytterbium is predicted to be positive and relatively large (~ 0.5 eV), we observed no evidence for an elemental ion. The hydrides are most unusual for a rare earth and the only one that we observed with certainty was the dihydride -- it was also unusually weak. As is evident from the spectrum shown below, ytterbium forms two oxides, YbO^- and YbO_2^- , and the former is quite intense and a good candidate for acceleration in a tandem.

A Negative Ion Cookbook

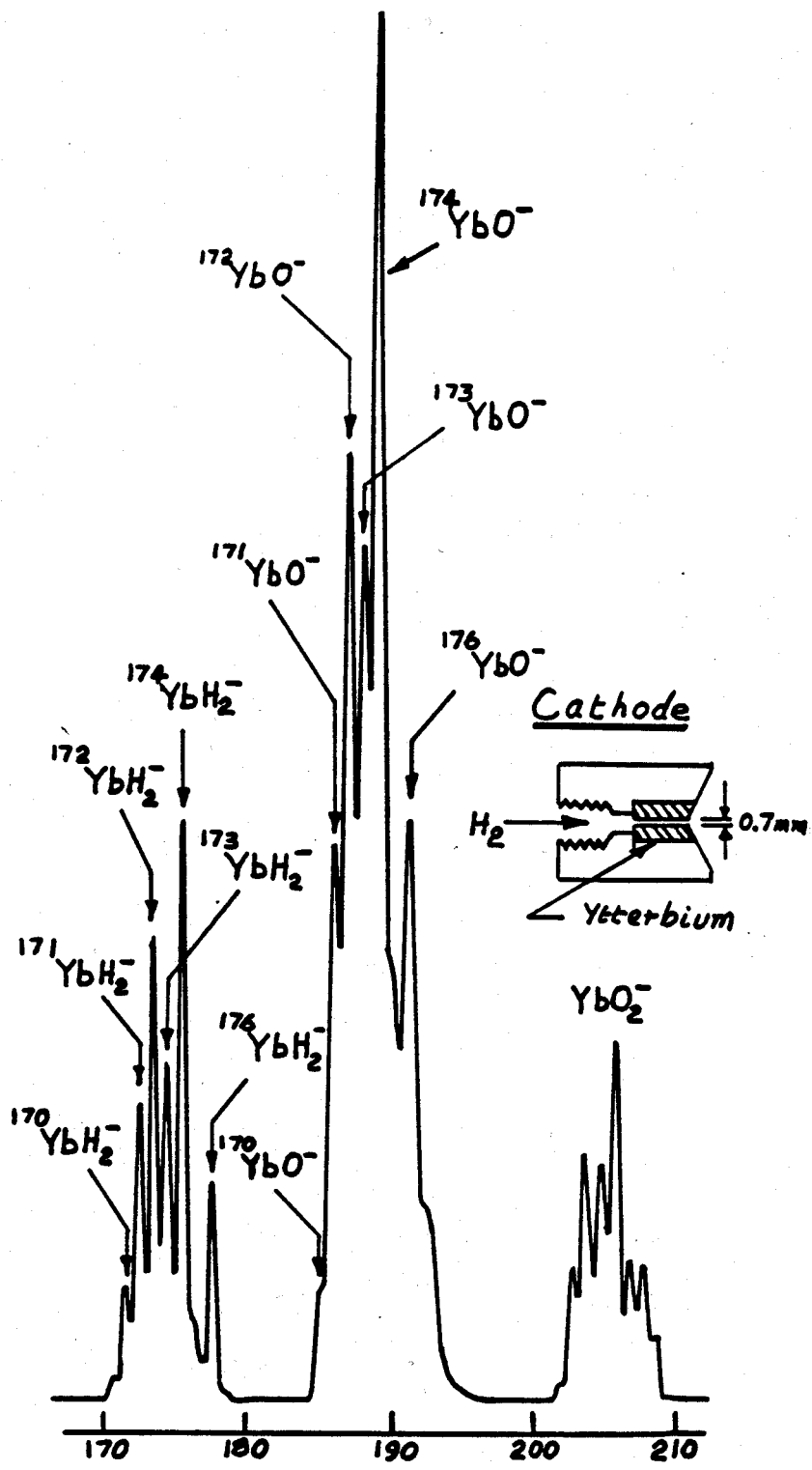

A negative ion spectrum measured, with a cathode like the one shown in the sketch, while hydrogen was being admitted. The effect of the hydrogen was surprising; 1) it caused little growth in the hydride and the maximum current of $^{174}\text{YbH}_2^-$ was only 80 nA, and 2) unlike most other rare earths no tetra-hydride was formed. No evidence was obtained for an elemental ion.

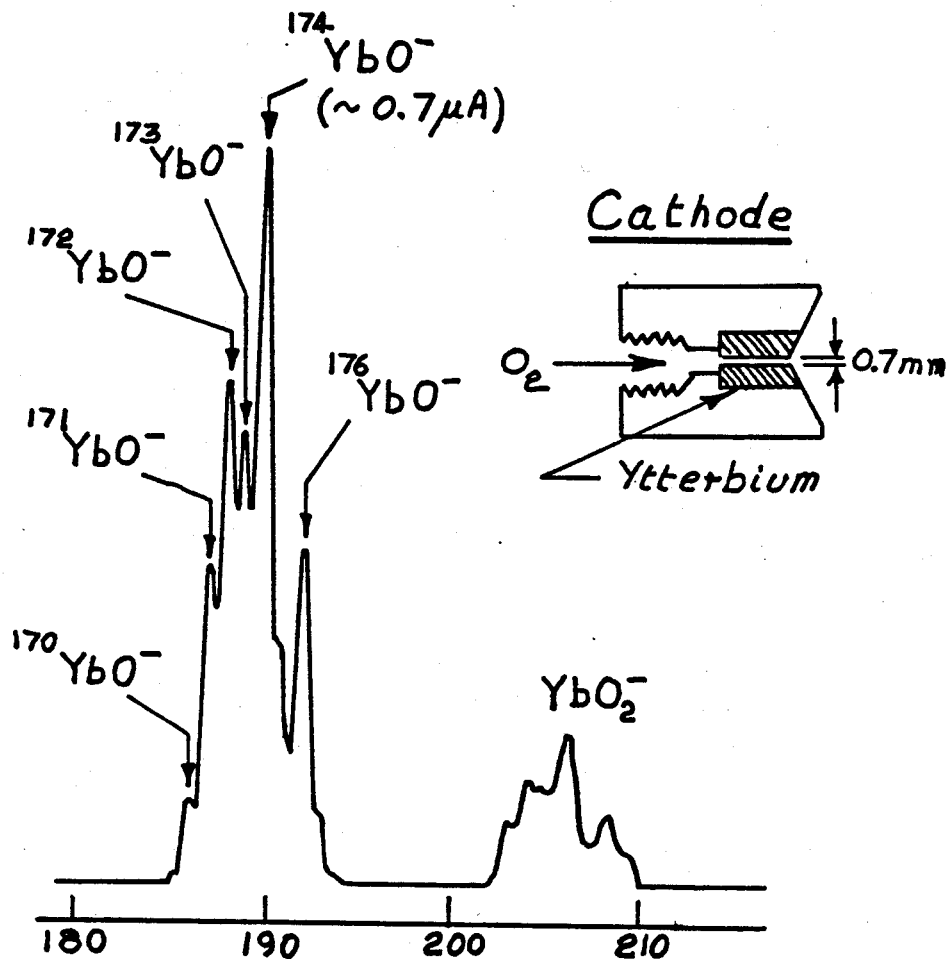

A spectrum measured with the same gas cathode as used with hydrogen while oxygen was being admitted. Ytterbium forms a fairly intense oxide and the $^{174}\text{YbO}^-$ current, measured through slits adjusted to ± 1.25 mm., was between 0.7 and 1 μA .

A Negative Ion Cookbook

71Lutetium

Isotopes

^{175}Lu - 97.40%, ^{176}Lu - 2.59%

Physical Properties

E.A. \approx 0.5 eV, I.P. = 5.43 eV, m-p- = 1663 °C, W.F. = 3.3 eV

Cathodes

No measurements have been made but the high melting point suggests that ionizer contamination may be a serious problem.

A Negative Ion Cookbook

72Hafnium

Isotopes

¹⁷⁴Hf - 0.16%, ¹⁷⁶Hf - 5.2%, ¹⁷⁸Hf - 27.1%, ¹⁷⁹Hf - 13.74%, ¹⁸⁰Hf - 35.2%

Physical Properties

E.A. ~ 0, I.P. = 7.0 eV, m.p. = 2227 °C, W.F. = 3.9 eV

Cathodes

Measurements have been made with cathodes containing compressed hafnium powder, the powder loaded with hydrogen, and hafnium oxide (HfO₂). Like the other members of its sub-group, titanium and zirconium, hafnium readily absorbs hydrogen, and following the procedures used with these elements we prepared some hafnium hydride (probably HfH₂). The hydride appeared quite stable and no difficulty was experienced while loading it into a cathode.

Since the results obtained with the elemental and hydride cathodes were disappointing we prepared some hafnium oxide by combusting a small piece of metal. Once ignited, the metal burned intensely, emitting a bright light. The residue, presumably HfO₂, was then loaded into a standard cathode.

Performance

The cathode containing compressed metal powder performed poorly, producing only weak clusters of hydrides and oxides, and little was learned from it. Since hafnium was reported to have an electron affinity of close to zero we wasted little further time on the elemental cathode and moved to a cathode containing the hydride. This performed better, but the hydride currents were still small (~120 nA of ¹⁸⁰HfH⁻) and generally much less than from titanium and zirconium hydrides. The spectrum was also much more complex, indicating the presence of several hydrides (see the upper left-hand spectrum overleaf). Careful analysis reveals the existence of 4 hydrides and we estimate the relative strengths of HfH⁻ : HfH₂⁻ : HfH₃⁻ : HfH₄⁻ are 1 : 1 : 0.2 : 0.3. With a spectrum as complex as this it is difficult to be sure whether hafnium forms a negative ion. However, a very weak peak at m = 176 suggests that it may, and possibly corresponds to ¹⁷⁶Hf⁻. The H⁻ current from this cathode was typically 30 μA -- somewhat less than observed from titanium and zirconium hydrides.

Since the hydrides are weak and the isotopes overlap one another due to the multiplicity of the hydrides, the hydride is not a good choice for acceleration in a tandem. This prompted us to try an oxide cathode, and we were delighted by its performance. Within minutes it was producing 2 to 4 μA of ¹⁸⁰HfO⁻ ions, measured through exit slits adjusted to ± 1.25 mm. The cathode ran extremely stably and was generally very satisfactory.

Molecular Ions

It is possible that hafnium forms a stable negative ion, but it certainly has a very small electron affinity. It also forms at least 4 hydrides that are significantly weaker than those of titanium and zirconium. As already mentioned it forms a prolific oxide (HfO⁻) and also a very weak dioxide (HfO₂⁻).

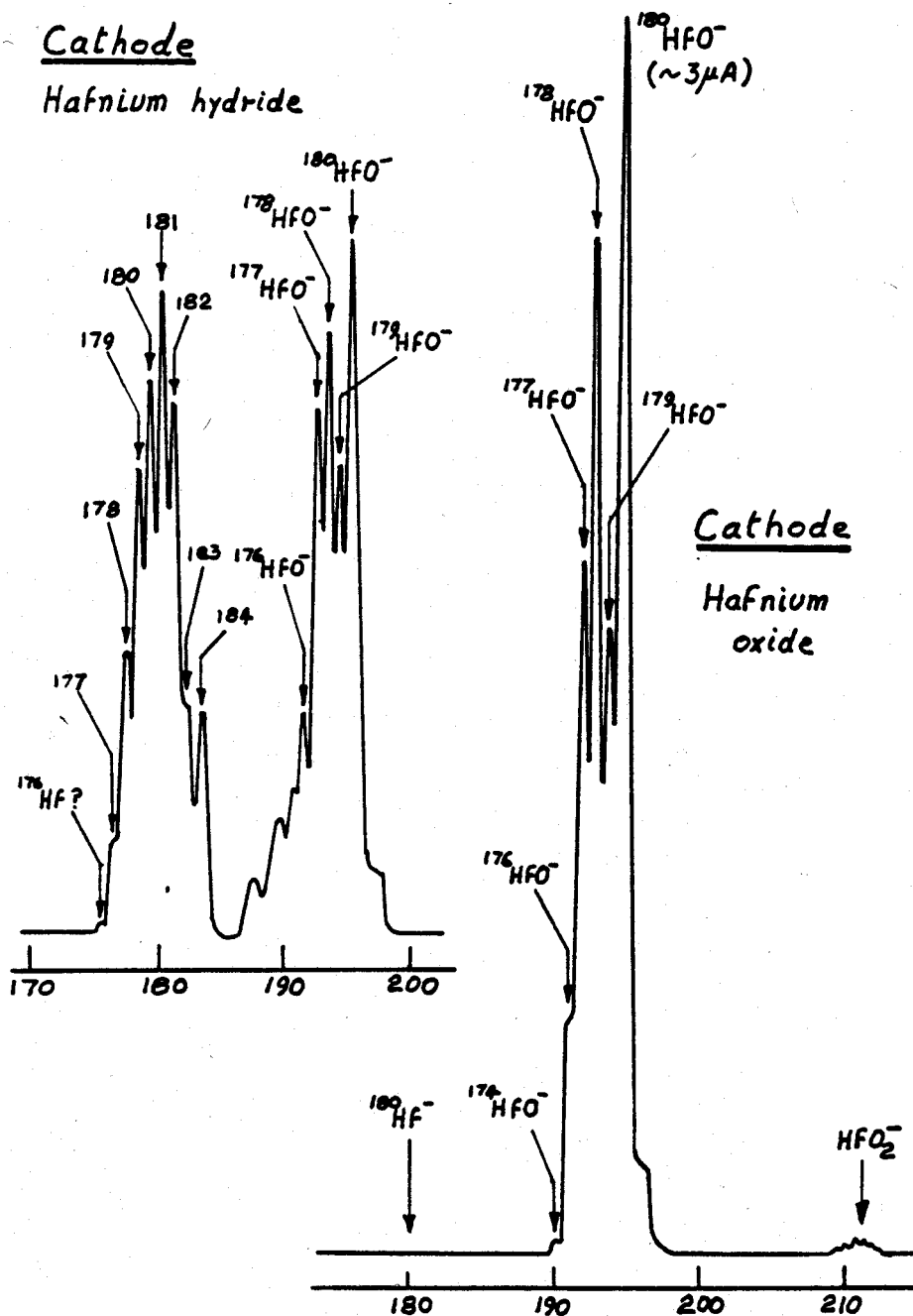

The upper left-hand spectrum was recorded with a standard cathode containing hafnium metal powder that we had loaded with hydrogen (it absorbs hydrogen very much like titanium and zirconium). Performance was rather disappointing and not only are the hydride currents small (~ 100 nA) but there are a multiplicity of hydrides. The lower right hand spectrum was obtained from a cathode containing combusted hafnium metal, presumably HfO_2 . It performed extremely well and produced stable currents of 2 to 4 μA of $^{180}\text{HfO}^-$ for over 2 hours.

A Negative Ion Cookbook

⁷³Tantalum

Isotopes

¹⁸⁰Ta - 0.01%, ¹⁸¹Ta - 99.99%

Physical Properties

E.A. = 0.322 eV, I.P. = 7.88 eV, m.p. = 2996 °C, W.F. = 4.25 eV

Cathodes

Measurements have been made with a cathode containing the metal, a gas cathode that was used with oxygen, ammonia, and carbon dioxide, and a standard cathode loaded with a mixture of tantalum and graphite powders. The elemental and gas cathodes were made by pressing 5 mm long pieces of 3 mm diameter rod into copper cathodes. A 0.7 mm diameter gas admittance hole was drilled completely through the gas cathode and the same drill was used to drill a hole about 1.5 mm deep in the face of the elemental cathode.

Performance

In spite of being pre-drilled the elemental cathode performed poorly and took over an hour to stabilize. Initially it produced about 200 nA of current but this was mainly hydrides ranging from TaH⁻ to at least TaH₄⁻. With time the elemental current grew and the hydrides declined, and after about 1½ hours the latter had all but disappeared, leaving about 0.25 μA of ¹⁸¹Ta⁻. In addition to the elemental ion, this cathode also produced weak currents of TaC⁻, TaN⁻, and TaO⁻ -- see spectrum overleaf.

The tantalum gas cathode with oxygen performed very well producing 10 to 15 μA of TaO₂⁻. Rather surprisingly this was the strongest oxide and we estimate the ratio of TaO⁻ : TaO₂⁻ : TaO₃⁻ to be about 1 : 15 : 3. Unfortunately no measurements were made with a solid cathode containing tantalum oxide, but it would be surprising if it failed to produce similar currents.

The same cathode performed well with carbon dioxide, a combination that we investigated as a potential source of carbon ions for ¹⁴C dating. As expected the oxides (and in particular TaO₂⁻) were quite strong, but we were surprised to observe 5 to 6 μA of TaC⁻ ions. Since the latter is a better choice than TaO₂⁻ for tandem acceleration we prepared a cathode from a mixture of tantalum powder and graphite filings, approximately 1 : 1 by atom. This performed spectacularly well and within 10 minutes was producing 8 μA of TaC⁻, rising to 16 μA over a 3 hour period. In addition to TaC⁻, progressively weaker peaks were observed corresponding to TaC₂⁻, TaC₃⁻, and TaC₄⁻ -- see spectrum overleaf.

Some measurements were also made with a gas cathode and ammonia in an attempt to enhance the hydrides. This was not very successful, but surprisingly produced 5 to 8 μA of TaN⁻ ions and about 0.3 μA of TaN₂⁻.

Molecular Ions

In addition to a weak elemental ion, tantalum forms a multiplicity of weak hydrides extending to at least TaH₄. It also appears to form 4 carbides and 2 nitrides, with TaC⁻ and TaN⁻ particularly strong. The oxides, of which we have observed 3, are also strong, the most intense being TaO₂⁻.

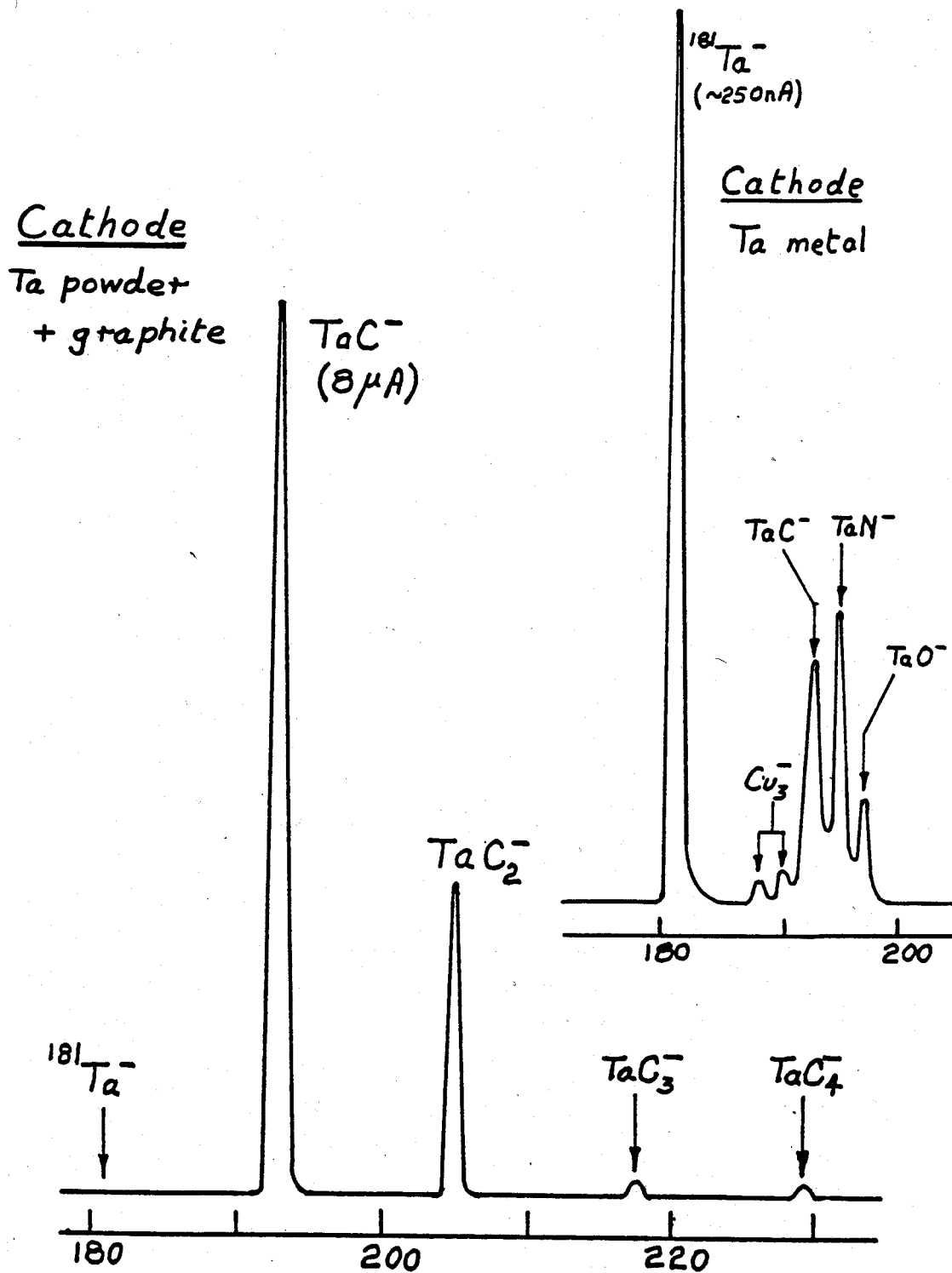

The upper right-hand spectrum was measured with an elemental cathode. In spite of being pre-drilled it took almost 90 minutes for the elemental current to attain a plateau of about 0.25 μA . During this time the hydrides, which initially were stronger than the elemental ion, gradually disappeared. The lower left-hand spectrum was measured with a standard cathode loaded with a mixture (~ 1 : 1 by atom) of tantalum powder and graphite filings. The cathode performed extremely well and produced between 8 and 16 μA of TaC^- ions for a little over 3 hours.

A Negative Ion Cookbook

⁷⁴Tungsten

Isotopes

¹⁸⁰W - 0.13%, ¹⁸²W - 26.3%, ¹⁸⁴W - 30.67%, ¹⁸⁶W - 28.6%

Physical Properties

E.A. = 0.815 eV, I.P. = 7.98 eV, m.p. = 3410 °C, W.F. = 4.55 eV

Cathodes

Measurements have been made with two elemental cathodes, one made from a 5 mm long piece of 3 mm diameter tungsten rod and the other from compressed tungsten powder, a cathode containing a mixture of tungsten and graphite powders, and one containing tungsten oxide. The latter was home prepared and judging from its color (canary yellow) was probably WO₃.

Performance

Since the cathode containing a piece of tungsten rod was not pre-drilled and tungsten has a low sputter rate, the current rose very slowly. Indeed, during the first 3 hours the ¹⁸⁰W⁻ current climbed from only 60 to 120 nA, but shortly thereafter it grew quickly and soon exceeded 1 μA. Overleaf is shown a portion of the negative ion spectrum and also a graph showing the growth of the ¹⁸⁰W⁻ current with time. It may be noted that the analyzing magnet slits were closed to ± 1.25 mm to resolve the tungsten isotopes, causing a current reduction of about one half. After about 9 hours of operation the tungsten current fell precipitously and the ⁶³Cu⁻ current grew to the surprisingly large value of 50 μA. When the cathode was removed from the source and examined under a microscope it was clear that the tungsten was completely perforated with a narrow and almost parallel hole of 0.6 to 0.7 mm diameter (see sketch).

The tungsten powder cathode performed quite well, and although the yield was less than from the rod cathode, the current rose more quickly and was almost 1 μA after an hour (see dashed line on graph overleaf). Initially the spectrum contained fairly intense clusters of peaks corresponding to WO⁻, WO₂⁻, WO₃⁻, and WO₄⁻, but these gradually declined until the strongest was comparable with the elemental cluster.

The same powder when mixed with graphite (~ 1 : 1 by atom) performed superbly, and within minutes was producing 2 to 4 μA of ¹⁸⁴WC⁻ and weaker currents of WC₂⁻. A spectrum obtained with this cathode is shown on the following page. Also shown is a spectrum obtained from a cathode containing tungsten oxide. This also ran well producing 4 oxides ranging from WO⁻ to WO₄⁻. The strongest of these was WO₃⁻ and the ¹⁸⁴WO₃⁻ current was typically 2 to 3 μA.

Recommended Cathode

The elemental ion is best produced from a solid metallic cathode but should be pre-drilled -- a none too easy task, probably best done by spark drilling. Compressed tungsten powder cathodes are more convenient and perform almost as well, but don't last as long. We particularly liked the cathode containing tungsten and graphite powders, and WC⁻ would be our choice for acceleration through a tandem.

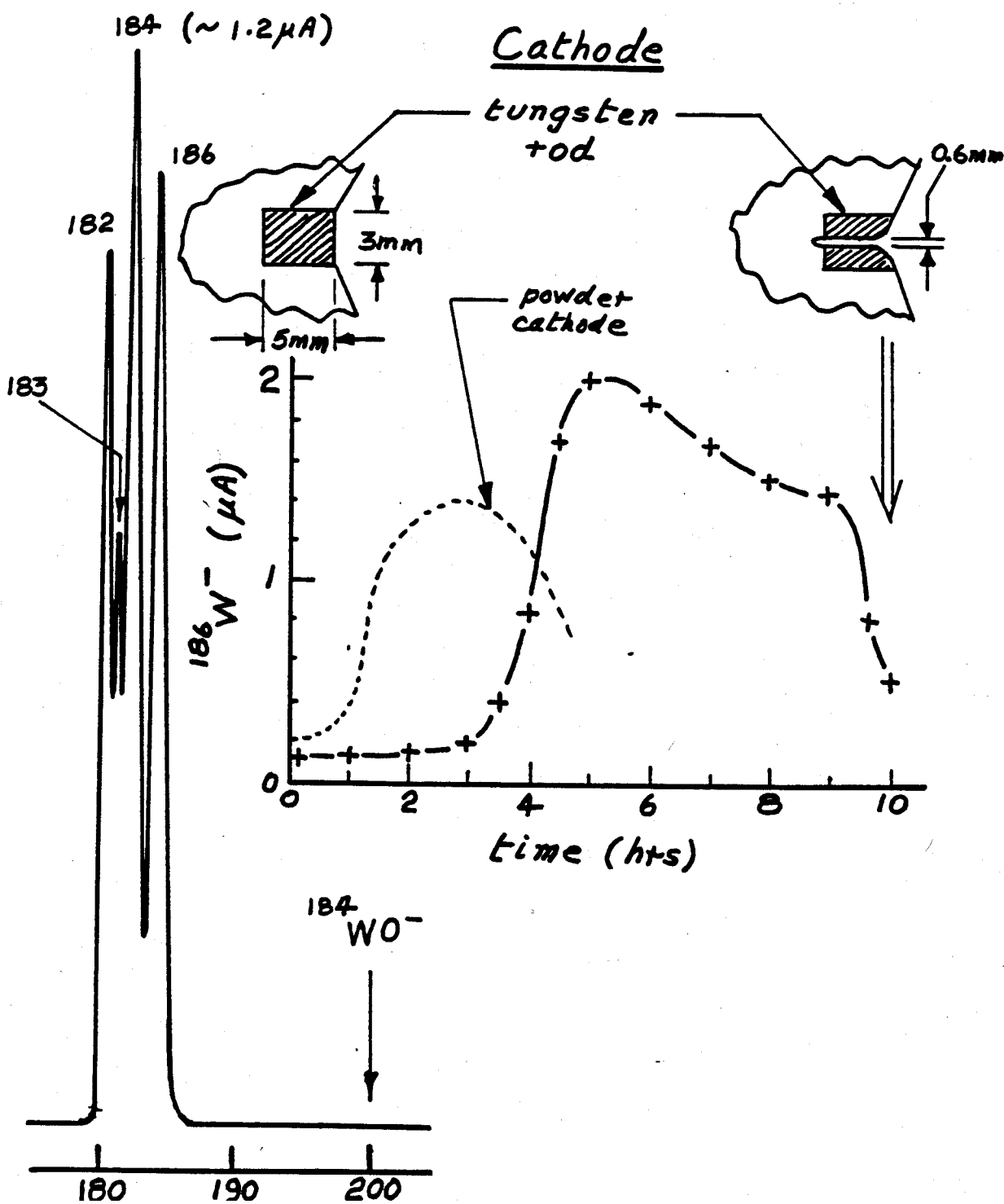

The spectrum on the left was measured with a cathode containing a piece of 3 mm diameter tungsten rod. The current from this cathode rose extremely slowly and the full line in the graph on the right shows how the $^{186}\text{W}^-$ current grew with time. The long rise time is undoubtedly due to the cathode not being pre-drilled and the low sputter rate of tungsten. After 9 hours of operation the $^{186}\text{W}^-$ current began a precipitous fall and a large copper current was seen. Removal of the cathode showed that the 5 mm long piece of tungsten was completely sputtered through as in the above sketch.

A Negative Ion Cookbook

Molecular Ions

In addition to the elemental ion, tungsten forms a weak dimer, W_2^- , with about 10 to 30% the strength of the elemental ion. Rather unusually we observed no evidence of hydrides, but we did observe two carbides, WC^- and WC_2^- , the former being particularly intense. Tungsten forms 4 oxides ranging from WO^- to WO_4^- , and from an oxide cathode WO_3^- is usually strongest.

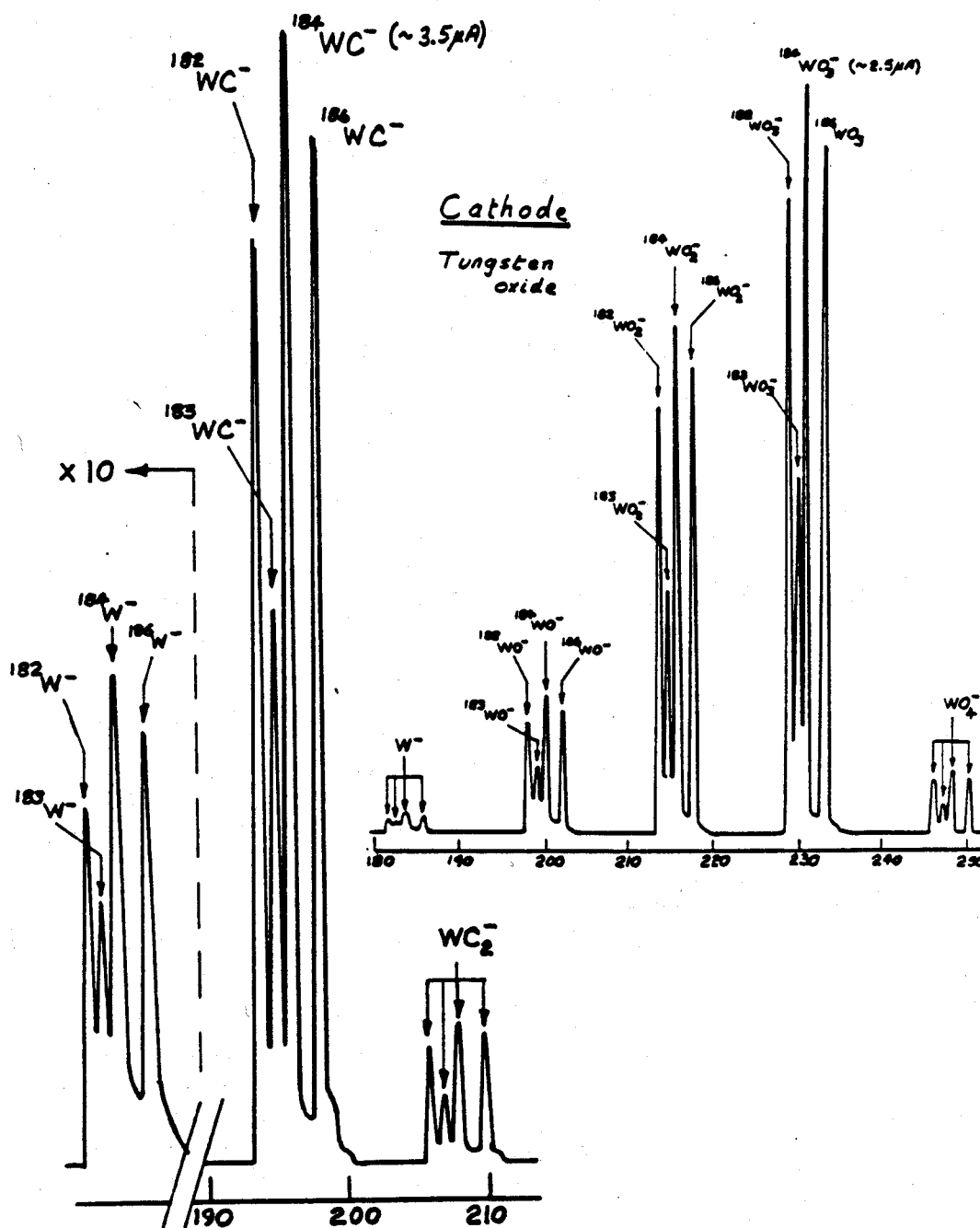

The lower left-hand spectrum was obtained from a cathode containing a compressed mixture ($\sim 1 : 1$ by atom) of tungsten and graphite powders. It performed extremely well and within minutes was producing 2 to 4 μA of $^{184}WC^-$. This is probably the most convenient tungsten ion to accelerate in a tandem.

The upper right-hand spectrum was obtained from a cathode containing home-prepared tungsten oxide, probably WO_3^- . It also performed well but the largest currents are of WO_3^- .

A Negative Ion Cookbook

75Rhenium

Isotopes

¹⁸⁵Re - 37.4%, ¹⁸⁷Re - 62.6%

Physical Properties

E.A. = 0.15 eV, I.P. = 7.88 eV, m.p. = 3180 °C, W.F. = 4.96 eV

Cathodes

The first cathode that we tried was made from 1 mm diameter rhenium wire. Three pieces, each 5 mm long, were pressed into a 3.1 mm diameter hole in a copper cathode in the form of an equilateral triangle. Later, after some rhenium powder had been obtained, elemental cathodes were made from the compressed powder and we also made a very successful cathode from a mixture (~ 1 : 1 by atom) of rhenium and graphite powders.

Performance

The rhenium wire cathode performed reasonably well, and the ¹⁸⁷Re⁻ current grew slowly over a period of 2 hours from 100 to 300 nA -- a current commensurate with the 0.15 eV electron affinity of rhenium. We were surprised to observe a very intense dimer (Re₂⁻) with about 10 times the intensity of the elemental current. The powder cathodes produced about the same ¹⁸⁷Re⁻ current, but the current rose more quickly and the spectrum, particularly during the first hour, was dominated by the oxide ReO⁻. A typical Spectrum from a powder cathode is shown overleaf.

The cathode prepared by mixing rhenium metal and graphite powders performed extremely well and within minutes was producing 3 or 4 μA of ¹⁸⁷ReC⁻. Like so many metal/graphite cathodes that we have tested, it ran superbly, leaving little to be desired, and within one hour the ¹⁸⁷ReC⁻ current was greater than 6 μA. We unhesitatingly recommend ReC⁻ as the best rhenium ion for acceleration in a tandem.

Molecular Ions

Rhenium is not a prolific negative ion but it has a surprisingly strong dimer -- a situation reminiscent of aluminum. It almost certainly forms at least 2 hydrides, but we made no special attempt to enhance these. The carbide ion is particularly strong and in our view is the most suitable ion for acceleration in a tandem. In addition to ReC⁻ we also observed progressively weaker currents of ReC₂⁻ and ReC₃⁻. The oxide is also quite intense, and from the metal powder cathode, which at most is only partially oxidized, we observed ~ 1 μA of ¹⁸⁷ReO⁻.

A Negative Ion Cookbook

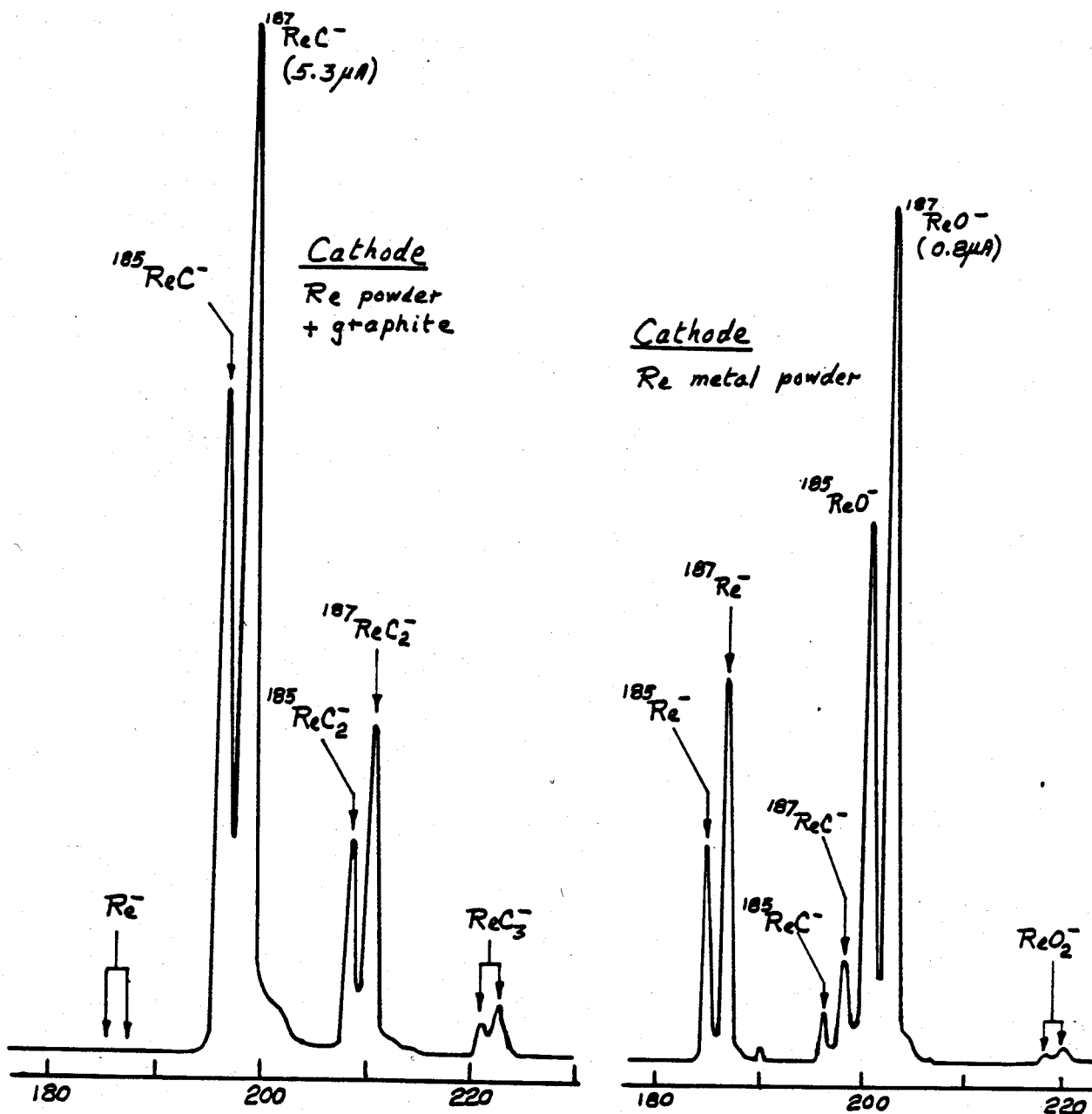

The spectrum on the right was obtained from a standard cathode loaded with compressed rhenium metal powder. As expected from its electron affinity (0.15 eV), rhenium is not a prolific negative ion, and typical $^{187}\text{Re}^-$ currents were in the range 0.1 to 0.3 μA . The left-hand spectrum was measured with a cathode containing a 1: 1 by atom mixture of rhenium and graphite powders. It performed extremely well, producing 5 to 8 μA of $^{187}\text{ReC}^-$ for over 3 hours.

A Negative Ion Cookbook

⁷⁶Osmium

Isotopes

¹⁸⁴Os - 0.02%, ¹⁸⁶Os - 1.58%, ¹⁸⁷Os - 1.6%, ¹⁸⁸Os - 13.3%, ¹⁸⁹Os - 16.1%, ¹⁹⁰Os - 26.4%, ¹⁹²Os - 41.0%

Physical Properties

E.A. = 1.1 eV, I.P. = 8.7 eV, m.p. = 3045 °C, W.F. = 4.83 eV

Cathodes

Measurements have been made only with a standard cathode loaded with 60 mesh osmium powder. The latter loaded and bonded together extremely well and within minutes of insertion into the source it was producing 3 μA of ¹⁹²Os⁻. The current continued to grow and after about an hour it attained a plateau of about 10 μA , measured through analyzing slits set at ± 1.25 mm. that reduced the current by about one half. A typical negative ion spectrum measured with this cathode is shown overleaf. Judging from the appearance of the cathode, which was removed after 3 hours of very steady operation, lifetime should be at least 4 to 5 hours with ¹⁹²Os⁻ currents of ~ 10 μA .

Molecular Ions

Osmium, as might be expected from its moderately large electron affinity of 1.1 eV, is a fairly prolific negative ion and we thought it unnecessary to search for molecular alternatives. Indeed we minimized experimentation with osmium on account of its alleged toxicity, particularly that of its sesquioxide. However, in addition to the elemental ion we also observed a dimer with about 10% of the elemental ion's intensity. Also, a shoulder on the side of the ¹⁹²Os⁻ peak suggests the existence of at least one hydride. We also observed a weak oxide cluster -- see spectrum overleaf.

A Negative Ion Cookbook

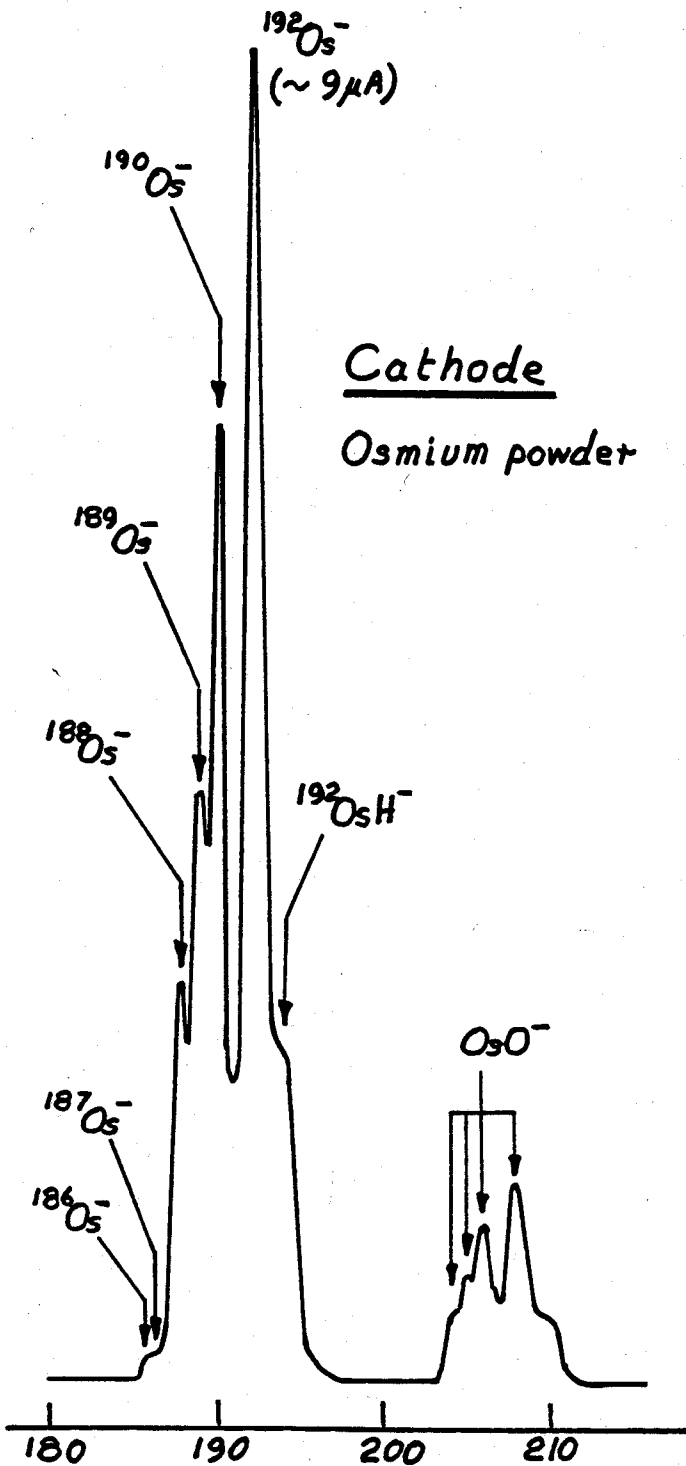

Osmium, with an electron affinity of 1.1 eV, is a fairly prolific negative ion and we had no difficulty in obtaining $10\ \mu\text{A}$ of $^{192}\text{Os}^-$ ions from a standard cathode loaded with 60 mesh osmium powder.

A Negative Ion Cookbook

77Iridium

Isotopes

¹⁹¹Ir - 37.3%, ¹⁹³Ir - 62.7%

Physical Properties

E.A. = 1.565 eV, I.P. = 9.1 eV, m.p. = 2410 °C, W.F. = 5.27 eV

Cathodes

The only measurements that we have made were with standard cathodes loaded with 60 mesh iridium powder. These performed extremely well and within minutes were producing 10 μA of ¹⁹³Ir⁻ ions, rising quickly to between 20 and 30 μA . A typical spectrum, recorded after about 20 minutes, is shown overleaf. Initially the spectra usually contained fairly strong peaks corresponding to IrO⁻ and IrO₂⁻, but these fell rapidly with time and after about an hour were barely visible. We estimate that a 3mm deep cathode would last for at least 3 or 4 hours.

Molecular Ions

Iridium is a very prolific negative ion and we saw no need to make a systematic search for molecular ions. However, we did observe a weak dimer with about 6% the elemental intensity, and the spectrum overleaf shows some indications of a hydride and a carbide. The oxides, particularly IrO⁻, appear to be quite intense.

A Negative Ion Cookbook

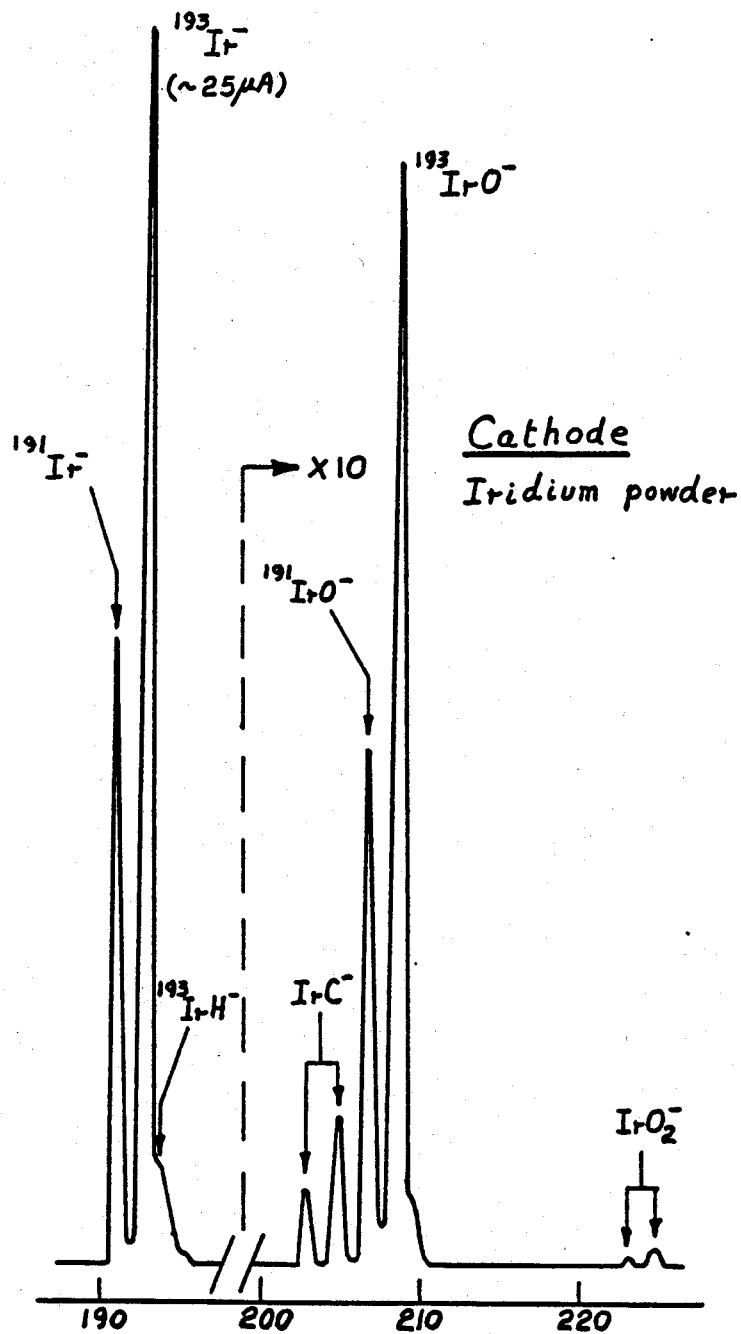

A spectrum measured with a standard cathode loaded with 60 mesh iridium powder. These cathodes performed extremely well and produced strong steady beams of $^{193}\text{Ir}^-$ which rapidly climbed from 10 to about 30 μA .

A Negative Ion Cookbook

78Platinum

Isotopes

¹⁹⁰Pt - 0.01%, ¹⁹²Pt - 0.79%, ¹⁹⁴Pt - 32.9%, ¹⁹⁵Pt - 33.8%, ¹⁹⁶Pt - 25.3%, ¹⁹⁸Pt - 7.2%

Physical Properties

E.A. = 2.128 eV, I.P. = 9.0 eV, m.p. = 1772 °C, W.F. = 5.65 eV

Cathodes

Since platinum is a very prolific negative ion we considered it unnecessary to experiment with different cathode materials, and measurements have been made only with elemental cathodes. These were made either by melting (with an oxy-acetylene torch) platinum scrap into a ball and then pressing into a copper cathode, or by pressing platinum powder into a standard cathode.

Performance

Both kinds of cathodes performed extremely well and produced large currents, typically 100 to 150 μ A of all isotopes (i.e. with the analyzing slits opened to ± 6 mm). Most measurements were made with both the object and image slits closed to about ± 1.2 mm, reducing the real current by about a factor of 2.5, and a spectrum recorded this way is shown overleaf. The spectrum is unusually clean providing no evidence for hydrides, carbides, oxides, or other molecular ions other than a weak dimer with about 5% the strength of the elemental ion. Both types of cathode sputtered quickly and usually only lasted for 2 to 3 hours, however it is likely that platinum, like gold, has a large ionization efficiency (5 to 10%) and with modest currents cathodes might be expected to last for several hours.

Molecular Ions

As already mentioned, platinum forms few if any molecular ions other than the dimer Pt_2^- , which has about 5% the strength of the elemental ion.

A Negative Ion Cookbook

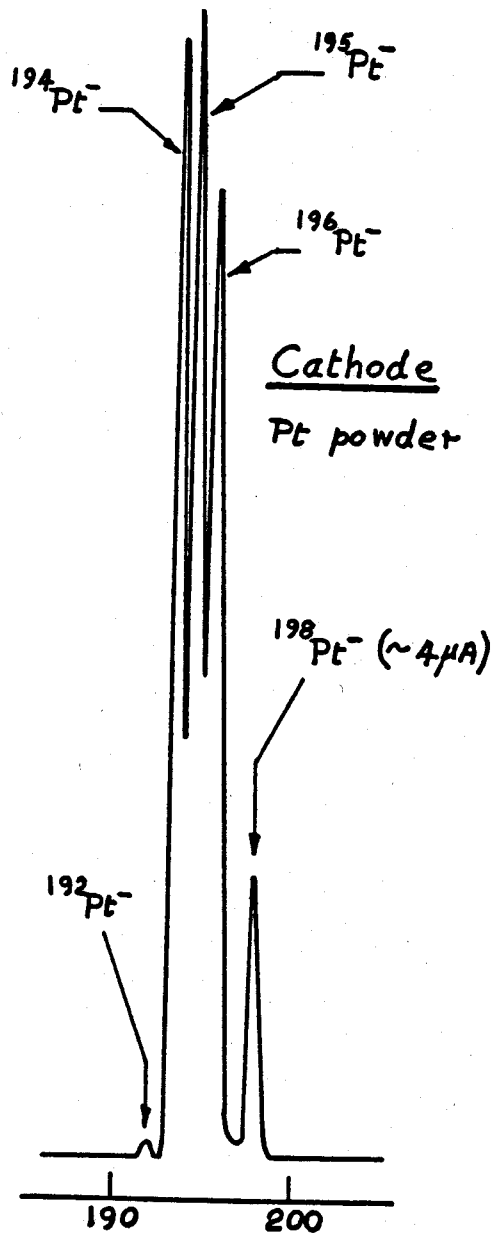

A portion of a negative ion spectrum measured with the object and image slits closed to ± 1.2 mm -- settings which attenuate the real current by a factor of about 2.5. Platinum, as one might expect from its electron affinity of 2.1 eV, is a very prolific negative ion and the total current, measured through slits opened to admit all isotopes, was typically 100 to 150 μA .

A Negative Ion Cookbook

⁷⁹Gold

Isotopes

¹⁹⁷Au - 100%

Physical Properties

E.A. = 2.309 eV, I.P. = 9.22 eV, m.p. = 1064 °C, W.F. = 5.1 eV

Cathodes

Like platinum, gold is a very prolific negative ion and since elemental cathodes perform so well we have not experimented much with alternatives. Until recently we made our cathodes by melting and forming a small gold ball about 2 to 3 mm in diameter and then pressing this into a slightly undersized hole drilled into a cathode. This type of cathode is particularly well suited to helical ionizer sources but with the improved focus of the spherical ionizer it is advantageous to use a smaller diameter but longer piece of gold. We now prepare cathodes by hammering gold filings into a 1.6 mm diameter by 4 to 5 mm deep hole drilled into a standard cathode. We usually prepare our own gold filings by filing a piece of fused gold scrap with a clean file.

Performance

The current from a gold cathode rises spectacularly and usually within minutes is 100 μ A or more. Recently, with a spherical ionizer source, we produced an average current of 160 μ A over a 7 hour period from a cathode containing 115 mg of gold, corresponding to an ionization efficiency of about 7%. Similar measurement made a few years ago with a helical ionizer source produced similar currents and efficiencies ranging from 5 to 11%.

Usually for each element we present at least one negative ion spectrum, but since that of gold is singularly uninteresting (one peak) we omit it.

Molecular Ions

No molecular ions whatsoever were observed from gold with the exception of a weak dimer, ¹⁹⁷Au₂⁻, with about 2 to 3% the strength of the elemental ion.

A Negative Ion Cookbook

80Mercury

Isotopes

¹⁹⁶Hg - 0.15%, ¹⁹⁸Hg - 10.1%, ¹⁹⁹Hg - 17%, ²⁰⁰Hg - 23.1%, ²⁰¹Hg - 13.2%, ²⁰²Hg - 29.65%, ²⁰⁴Hg - 6.8%

Physical Properties

E.A < 0, I.P. = 10-44 eV, m.p. = -38.8 °C, W.F. = 4.49 eV

Cathodes

Mercury, like zinc and cadmium, has a negative electron affinity, necessitating the use of a molecular ion, the most likely candidate being the oxide. Consequently we loaded a standard cathode with mercuric oxide (HgO, decomposes ~ 500 °C). The orange to red oxide loaded well but after hammering it had a rather ominous metallic look as if free mercury had been liberated. In the source it gassed very heavily and in spite of increasing the cathode voltage very slowly we were unable to exceed 3 kV without causing the vacuum to rise above 10⁻⁶ Torr. On removal from the source, after a fruitless 20 minutes, most of the oxide had disappeared from the cathode.

We are unaware of any mercury compounds that might be suitable for use in a cathode -- mercuric sulfide (HgS) is a possibility, but it sublimates at 584 °C. Several years ago we tried a sputter cone made from silver amalgam in a UNIS source. It was a disaster and we contaminated the whole source with mercury vapor. We have never had the courage to try it again but speculate that a properly prepared and hardened amalgam might make a good gas cathode, and with oxygen provide beams of HgO⁻.

A Negative Ion Cookbook

81Thallium

Isotopes

^{203}Tl - 29.52%, ^{205}Tl - 70.48%

Physical Properties

E.A = 0.2 eV, I.P. = 6.11 eV, m.p. = 303.5 °C, W.F. = 3.84 eV

Cathodes

To date we have made no measurements with thallium. However, since it is in the same chemical group as indium and has an even lower electron affinity we are not too hopeful about the elemental ion and favor the oxide. We hope to try a cathode containing thallium oxide shortly.

A Negative Ion Cookbook

82Lead

Isotopes

^{204}Pb - 1.4%, ^{206}Pb - 24.1%, ^{207}Pb - 22.1%, ^{208}Pb - 52.4%,

Physical Properties

E.A = 0.364 eV, I.P. = 7.42 eV, m.p. = 328 °C, W.F. = 4.25 eV

Cathodes

Lead is among one of the most frustrating elements that we have encountered, prompting us to make measurements with several different cathodes. These include elemental lead, lead alloyed with silver and antimony, and cathodes containing a mixture of lead and graphite filings, two different lead oxides (with and without silver powder) and lead sulfide.

Performance

Since lead has a small electron affinity and sputters very quickly, it is not surprising that elemental cathodes perform poorly. Currents tend to increase with agonizing slowness, and only after 40 or 50 minutes do they begin to rise rapidly to a maximum of about 0.25 μA ($^{208}\text{Pb}^-$). Unfortunately this maximum is short-lived and after 10 or 15 minutes the current usually falls precipitously, signaling the end of the cathode. In an attempt to reduce sputter rates and prolong cathode life we experimented with cathodes made from a lead-silver alloy of about 1 : 1 atom composition. These tended to run better and lasted longer than elemental cathodes but the current was usually less, typically about 150 nA of $^{208}\text{Pb}^-$. The lead-antimony alloy cathode, which was made to produce negative ions of antimony, performed significantly worse than either of the above cathodes and $^{208}\text{Pb}^-$ currents were usually only 30 to 50 nA.

A cathode prepared from a mixture of lead and graphite filings was a great disappointment and we were fortunate to be able to identify peaks corresponding to PbC^- and PbC_2^- . The latter was the more intense but the current of $^{208}\text{PbC}_2^-$ was only ~ 100 nA.

Most lead oxide cathodes that we have tested were made from red lead (Pb_3O_4) and contained no silver powder. These produced unsteady and erratic currents of two oxides, PbO^- and PbO_2^- , the latter being 3 or 4 times stronger than the former. In addition to being unsteady, the currents from individual cathodes were highly unpredictable and cathode lifetime was usually, but not always, short. "Good" cathodes produced as much as 3 μA of $^{208}\text{PbO}_2^-$, but the current usually didn't last for more than 10 or 15 minutes and could never be relied upon. In an attempt to improve things we baked some of the red oxide converting it into yellow PbO (litharge). This performed little better and as a last resort some of this oxide was mixed with silver powder (approximately 1 : 1 by weight) and loaded into a cathode. Performance was vastly improved. Within 30 minutes the $^{208}\text{PbO}_2^-$ current was 1.5 μA and for the next 90 minutes currents hovered between 1.7 and 1.9 μA . A typical spectrum measured with this cathode is shown overleaf.

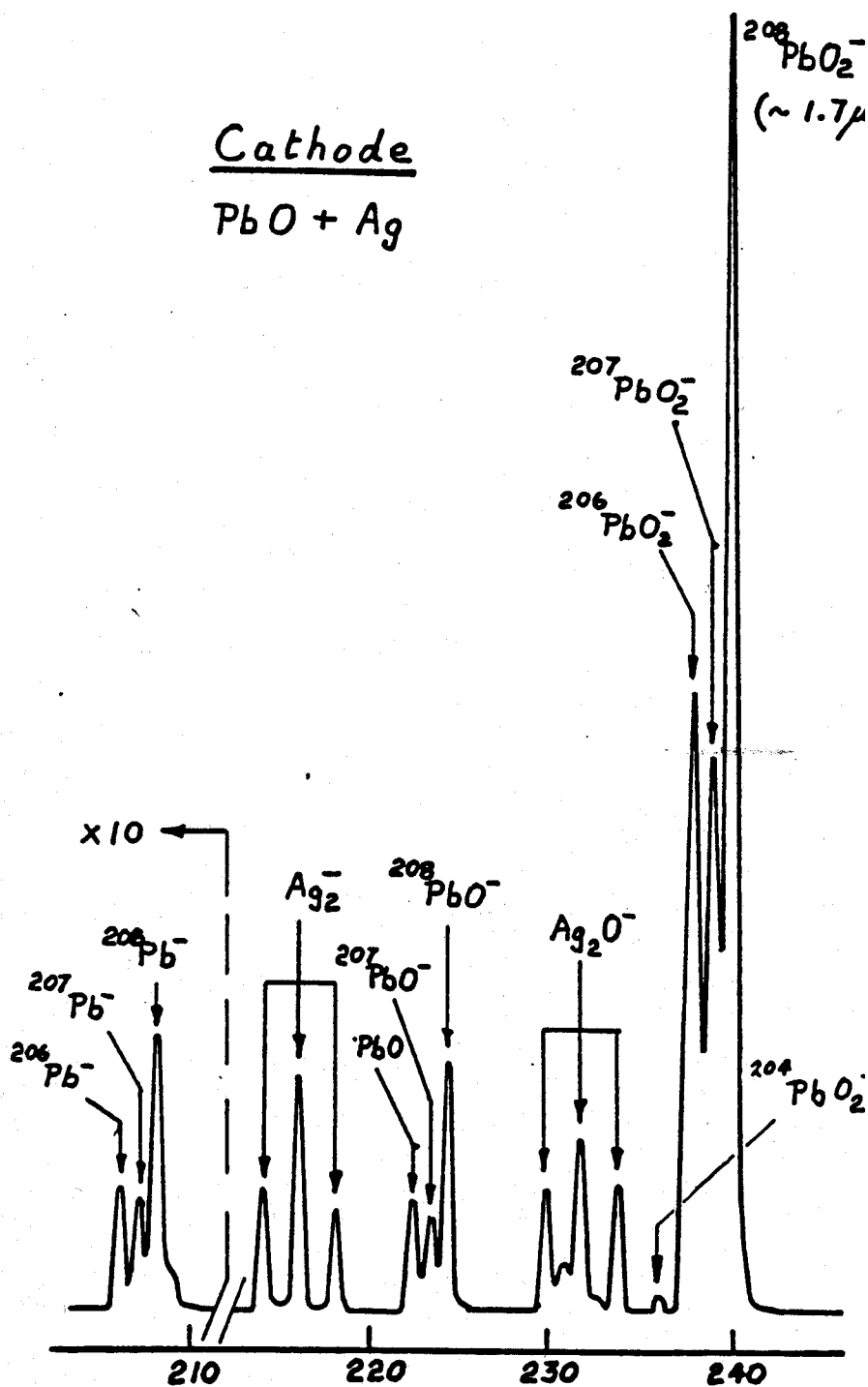

A spectrum measured with a cathode containing a mixture of litharge (PbO) and silver powder (~ 1 : 1 by weight). This cathode ran quite smoothly, unlike most oxide cathodes without silver, and gave between 1.5 and 2.0 μA of $^{208}\text{PbO}_2^-$ for over 2 hours.

A Negative Ion Cookbook

From previous experience with lead sulfide, which was often used as a source of sulfur ions, we were aware that it ran reasonably stably and did not require mixing with silver. However, we had never looked at the yield of elemental and molecular ions of lead. A spectrum from this cathode is shown below and as can be seen the elemental current is very small (~ 20 nA of $^{208}\text{Pb}^-$) but the yield of $^{208}\text{PbS}^-$ is reasonably large, between 1.4 and 1.8 μA . Cathode life was between 2 and 3 hours.

Molecular Ions

The only molecular ions of lead that we have observed are the carbides (PbC^- and PbC_2^-), the oxides (PbO^- and PbO_2^-), and the sulfides (PbS^- and PbS_2^-). We observed no evidence of hydrides and we never looked to see if lead has a dimer ion.

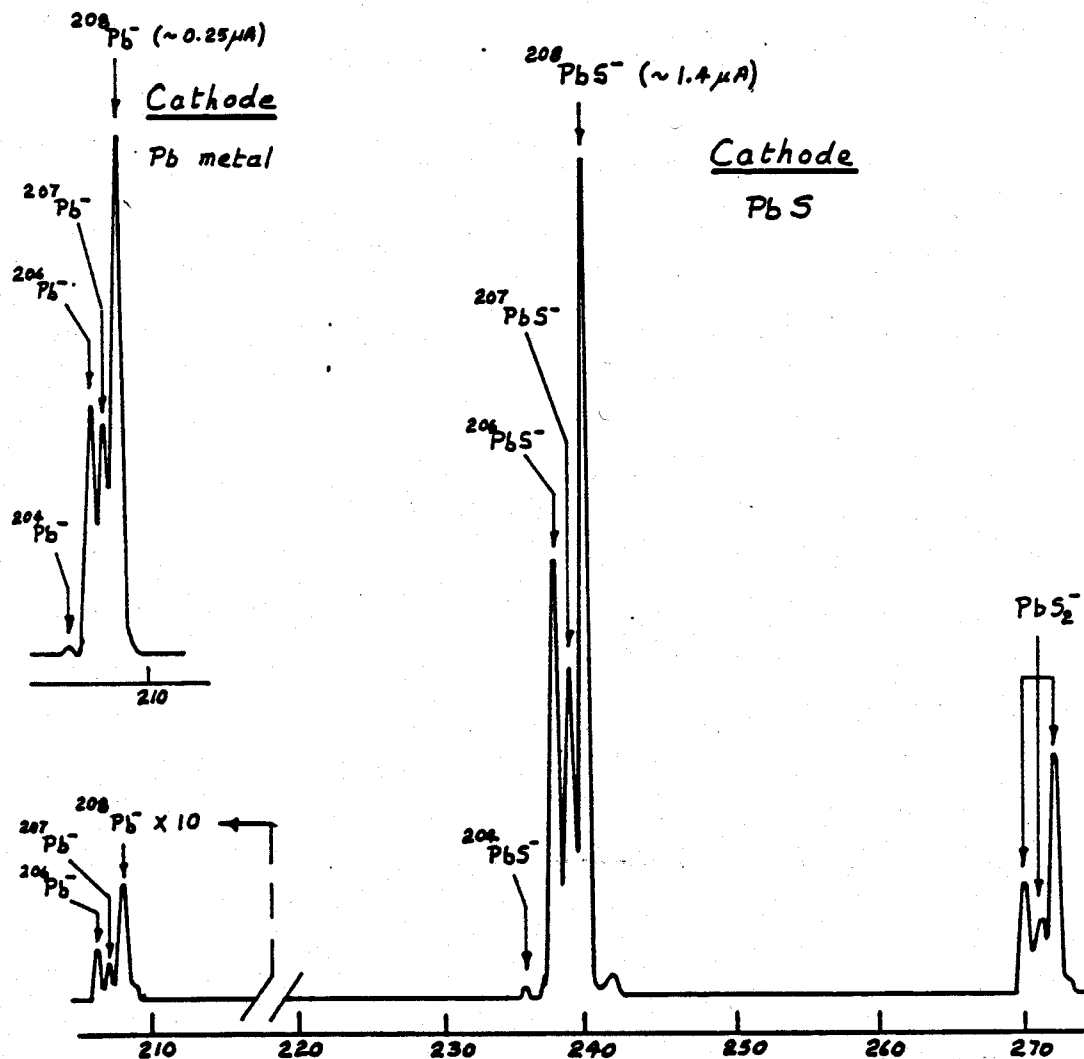

Lead sulfide, even without silver powder, runs quite well and the current of $^{208}\text{PbS}^-$ was remarkably steady for a little over 2 hours. The elemental ions from this cathode were extremely weak (~ 20 nA of $^{208}\text{Pb}^-$), much less than from an elemental cathode (see spectrum immediately above). However, the elemental cathode has a very short lifetime and usually only gives a peak current of $\sim 0.25 \mu\text{A}$ ($^{208}\text{Pb}^-$) for 10 to 15 minutes.

A Negative Ion Cookbook

83Bismuth

Isotopes

²⁰⁹Bi - 100%

Physical Properties

E.A = 0.946 eV, I.P. = 7.29 eV, m.p. = 271 °C, W.F. = 4.22 eV

Cathodes

The only cathodes that we have tried were elemental. One was made by hammering a piece of bismuth metal shot about 3 mm in diameter into a cathode, but since this quickly sputtered through a second cathode was made by hammering bismuth metal powder into an extra-deep (- 6 mm) hole in a standard cathode.

Performance

Both cathodes performed reasonably well and almost immediately produced micro-ampere currents, but like lead, bismuth sputters quickly and the cathode made from shot lasted for only 45 minutes. The extra-deep powder cathode lasted much longer and once a deep sputter crater had formed the elemental current steadied and remained about 2 μA for almost 4 hours. A negative ion spectrum from this cathode is shown overleaf.

Molecular Ions

We were rather surprised to find that bismuth forms a strong dimer ion (²⁰⁹Bi₂⁻) with a somewhat variable intensity ranging from 2 to 4 times that of the elemental current (seemingly influenced by the depth of the sputter crater). The bismuth powder cathode, particularly during the first 30 minutes, produced quite strong beams of BiO⁻ and BiO₂⁻, but no BiO₃⁻ (see spectrum over- leaf). No evidence was observed for a hydride ion. Although we have frequently observed ions of the type XCu⁻, these are usually weak and we were very surprised to observe ~ 2 μA of ²⁰⁹Bi⁶³Cu⁻ and about 1 μA of ²⁰⁹Bi⁶³CU₂⁻.

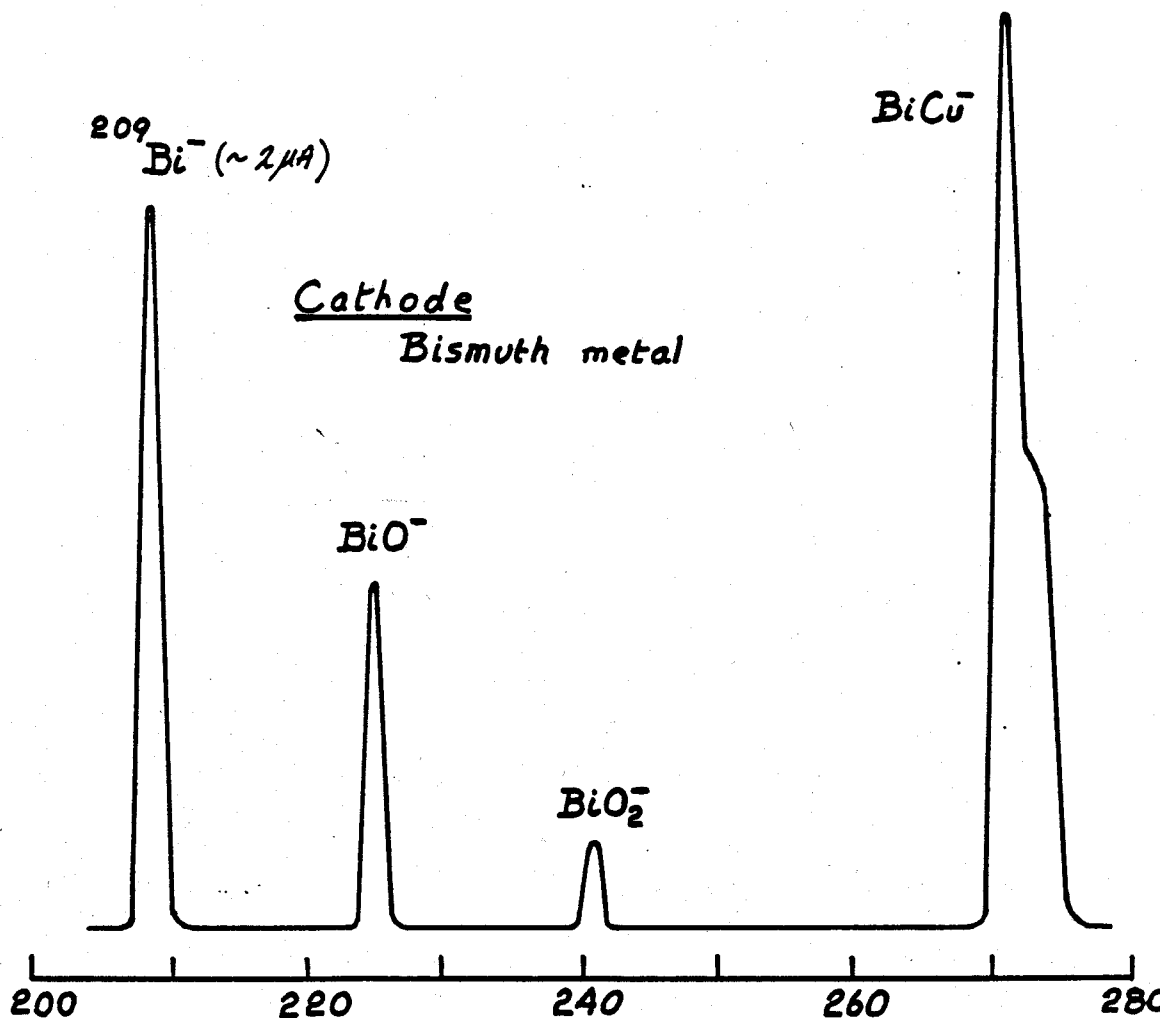

A spectrum obtained with a standard cathode, which had been drilled unusually deep (- 6 mm) and filled with hard tamped bismuth metal powder. After about 45 minutes the $^{209}\text{Bi}^-$ current stabilized around $2\mu\text{A}$ and remained there for almost 4 hours. The currents of BiO^- and BiO_2^- were initially comparable to the elemental current but gradually declined. Note the strong peaks corresponding to $^{209}\text{Bi}^{63}\text{Cu}^-$ and $^{209}\text{Bi}^{63}\text{Cu}_2^-$.

A Negative Ion Cookbook

⁸⁴Polonium

Isotopes

Polonium has many isotopes but all are radioactive. The longest-lived isotope is ²⁰⁹Po (T_{1/2} = 103 years).

Physical Properties

E.A = 1.9 eV, I.P. = 8.42 eV, m.p. = 254 °C, W.F. = ?

Cathodes

No measurements have been made.

A Negative Ion Cookbook

$_{85}\text{Astatine}$

Isotopes

Astatine has many isotopes but all are radioactive and the longest-lived isotope is ^{210}At ($T_{1/2} = 8.3$ hours).

Physical Properties

E.A = 2.8 eV, I.P. = 9.5 eV, m.p. = 302 °C, W.F. = ?

Cathodes

No measurements have been made with astatine.

A Negative Ion Cookbook

⁸⁶Radon

Isotopes

Radon has many isotopes but all are radioactive. The longest-lived isotope is ^{222}Rn ($T_{1/2} = 3.82$ days).

Physical Properties

E.A. < 0, I.P. = 10.75 eV, m.p. = -71 °C (noble gas)

Cathodes

None.

A Negative Ion Cookbook

⁹⁰Thorium

Isotopes

²³²Th - 100% ($T_{1/2} = 1.4 \times 10^{10}$ years)

Physical Properties

E.A - 0.5 eV, I.P. = 6.95 eV, m.p. = 1750 °C, W.F. = 3.4 eV

Cathodes

We have briefly made measurements with a cathode containing crushed thoria (ThO₂). It performed poorly and like many rare earth oxides it appeared to poison the ionizer, causing the cathode current to fall below 0.5 mA. However, we were able to identify with reasonable certainty weak peaks corresponding to ThO⁻, ThO₂⁻, and ThO₃⁻, the strongest of which was ThO₂⁻ (~ 50 nA). Extremely weak peaks were also observed corresponding to the elemental ion and to ThO₄⁻, but these identifications are less certain. It is noteworthy that the ¹⁶O⁻ current from this cathode was only 5 to 6 μA -- at least an order of magnitude less than we would normally expect from an oxide.

A Negative Ion Cookbook

₉₁Protactinium

Isotopes

Protactinium has several isotopes, all of which are radioactive. The longest-lived is ²³¹Pa with a half-life of 3.2×10^4 years.

Physical Properties

E.A - 0.3 eV, I.P. = ?, m.p. < 1600 °C, W.F. = ?

Cathodes

None.

A Negative Ion Cookbook

$_{92}\text{Uranium}$

Isotopes

^{235}U - 0.72%, ^{238}U - 99.28%

Physical Properties

E-A - 0.3 eV, I.P. = 6.08 eV, m.p. = 1132 °C, W.F. = 3.63 eV

Cathodes

Measurements have been made with standard cathodes containing 60 mesh uranium metal powder, the same powder mixed with powdered graphite, and compressed uranium oxide. The latter was probably UO_2 and was prepared by combusting a small amount of the metallic powder in oxygen. Some measurements were also made with a gas cathode similar to the one shown overleaf in the inset sketch, with hydrogen, nitrogen, and oxygen.

Performance

The elemental cathode performed very poorly, and although some extremely weak peaks (~ 1 nA) were observed close to mass 238 (probably hydrides) we were unable to positively identify the elemental ion. The cathode containing a mixture of uranium and graphite powders was slow rising and required about an hour to stabilize, but thereafter it performed much better and for several hours produced about $0.25 \mu\text{A}$ of UC_2^- and about 75 nA of UC^- . A spectrum obtained with this cathode is shown overleaf. Again, no evidence was obtained for the elemental ion. The oxide-containing cathode performed extremely erratically and frequently gave rise to an electron current which caused the cathode voltage supply to collapse (> 30 mA). Indeed, stable performance was only possible after the Cs reservoir temperature had been considerably reduced, and with these conditions the current of UO^- was only about 50 nA and that of UO_2^- was even smaller.

The gas cathode generally was a disappointment, but while being used with hydrogen it permitted the positive identification of the elemental negative ion, confirming that uranium has a small but positive electron affinity. Overleaf is shown a portion of a spectrum measured while admitting hydrogen. As can be seen, the elemental peak is very weak (~ 1 nA), as are the stronger peaks corresponding to UH_2^- and UH_4^- . Uranium appears to form predominantly di- and tetra- hydride negative ions like the rare earth metals, but more weakly.

The same gas cathode was used with nitrogen and typically produced 120 nA of UN^- , but no UN_2^- . Performance with oxygen was highly unsatisfactory and generally similar to that with the solid oxide cathode.

Recommended Cathode

The cathode containing mixed graphite and uranium powders, after about an hour of low currents and unsteadiness, ran better than all other cathodes and produced a steady $0.25 \mu\text{A}$ Of UC_2^- ions.

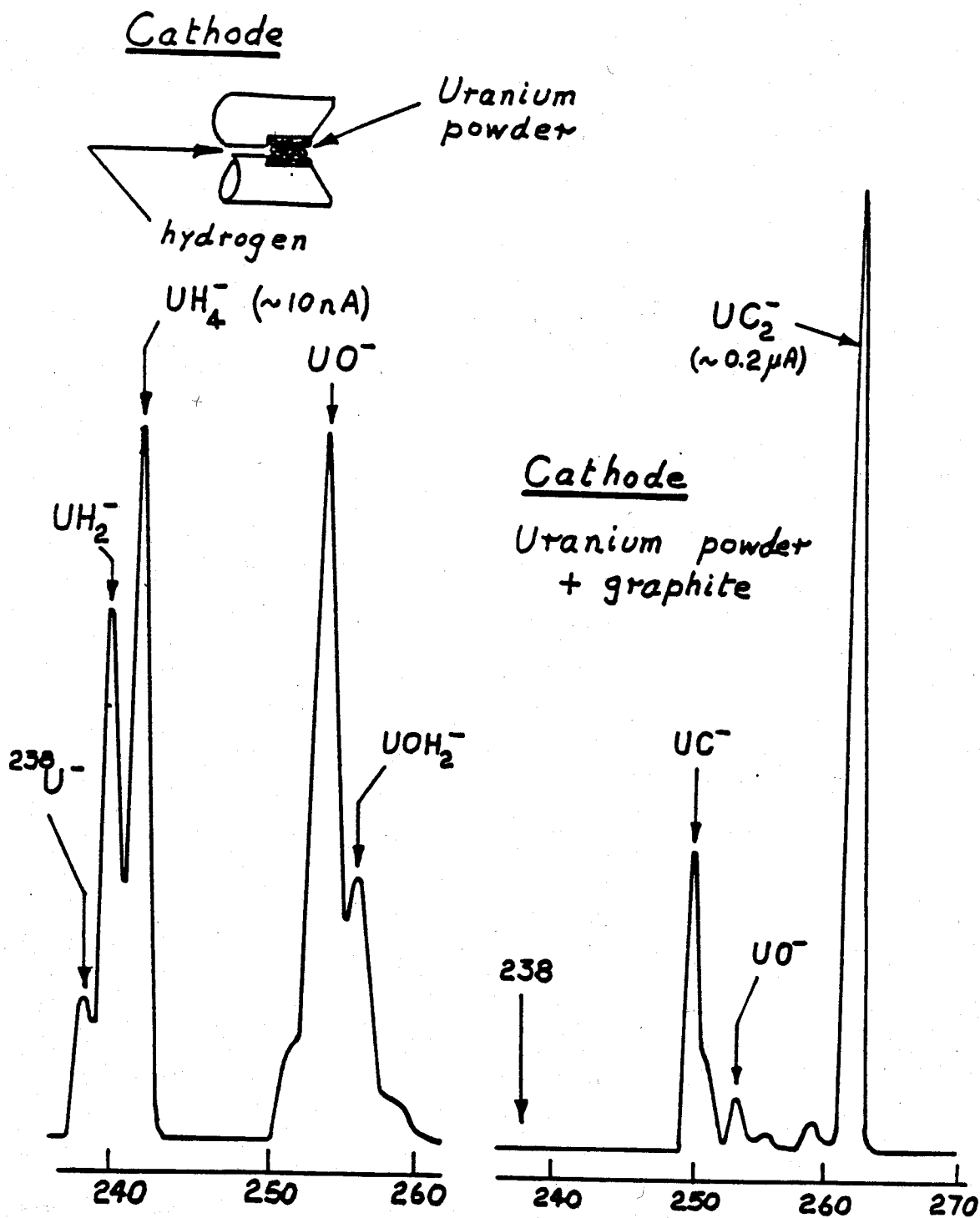

The spectrum on the left was measured with a gas cathode similar to that shown in the sketch and while admitting hydrogen. Yields were disappointingly small and the strongest hydride, UH_4^- , was only about 10 nA. The weak peak at $m = 238$ appears to correspond to the elemental ion and confirms that uranium has a positive electron affinity. The left-hand spectrum was obtained with a cathode containing a mixture of uranium and graphite powders. It performed well and for several hours gave 0.2 to 0.3 μA of UC_2^- ions.

Alphabetical Index

Aluminum	Hydrogen	Rhenium
Antimony	Indium	Rhodium
Argon	Iodine	Rubidium
Arsenic	Iridium	Ruthenium
Astatine	Iron	Samarium
Barium	Krypton	Scandium
Beryllium	Lanthanum	Selenium
Bismuth	Lead	Silicon
Boron	Lithium	Silver
Bromine	Lutetium	Sodium
Cadmium	Magnesium	Strontium
Calcium	Manganese	Sulfur
Carbon	Mercury	Tantalum
Cerium	Molybdenum	Technetium
Cesium	Neodymium	Tellurium
Chlorine	Neon	Terbium
Chromium	Nickel	Thallium
Cobalt	Niobium	Thorium
Copper	Nitrogen	Thulium
Dysprosium	Osmium	Tin
Erbium	Oxygen	Titanium
Europium	Palladium	Tungsten
Fluorine	Phosphorus	Uranium
Gadolinium	Platinum	Vanadium
Gallium	Polonium	Xenon
Germanium	Potassium	Ytterbium
Gold	Praseodymium	Yttrium
Hafnium	Promethium	Zinc
Helium	Protactinium	Zirconium
Holmium	Radon	Back to Table